

RADIO CRAFT

AMATEUR
VHF TOWER
SEE PAGE 22

In this issue—

Miller-Effect Experimental FM
Receiver Oscillator Servicing
Versatile Portable Recorder

RADIO-ELECTRONICS IN ALL ITS PHASES

AUG

1947

25¢

CANADA

Why Mallory-Made Vibrators make the Best Replacements:



MORE MALLORY-MADE VIBRATORS ARE IN USE TODAY THAN ALL OTHER MAKES COMBINED

There are excellent mechanical and engineering reasons why more Mallory-made vibrators are used in original equipment than all other makes combined.



TWELVE MALLORY VIBRATORS ANSWER 90% OF YOUR REPLACEMENT NEEDS

Make replacements easily and quickly. Thanks to the Mallory program of standardization, the number of vibrators you need to meet most of your requirements is materially reduced—only twelve in all.



MALLORY HAS A COMPLETE VIBRATOR LINE

In addition to the 12 basic units, Mallory also makes 39 other replacement vibrators so that even when you meet a rare or unusual service problem, your Mallory distributor can supply the answer. The Mallory line leaves *nothing out*—it's a complete line that rounds out your business.

See Your Mallory Distributor for a free copy of the 1947 Replacement Vibrator Guide.

P. R. MALLORY & CO. Inc.
MALLORY

VIBRATORS... VIBRAPACKS... CAPACITORS... VOLUME CONTROLS... SWITCHES... RESISTORS... FILTERS... RECTIFIERS... POWER SUPPLIES.

*Reg. U. S. Pat. Off.

APPROVED PRECISION PRODUCTS

P. R. MALLORY & CO., Inc., INDIANAPOLIS 6, INDIANA



I Will Show You How to Learn RADIO by Practicing in Spare Time

I Send You Big Kits of Radio Parts

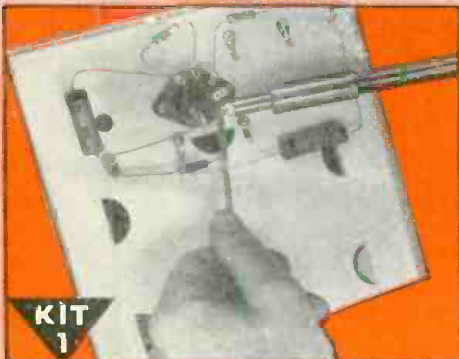

KIT 1
I send you Soldering Equipment and Radio parts; show you how to do Radio soldering; how to mount and connect Radio parts; give you practical experience.



KIT 2
Early in my course I show you how to build this N.R.I. Tester with parts I send. It soon helps you fix neighborhood Radios and earn EXTRA money in spare time.

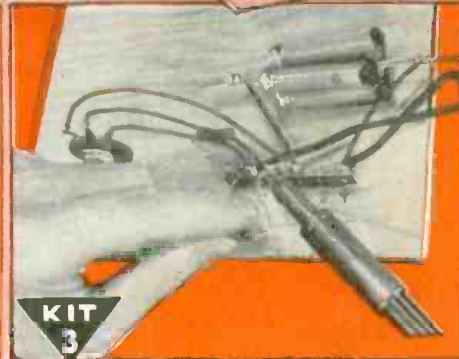

KIT 3
You get parts to build Radio Circuits; then test them; see how they work, learn how to design special circuits; how to locate and repair circuit defects.

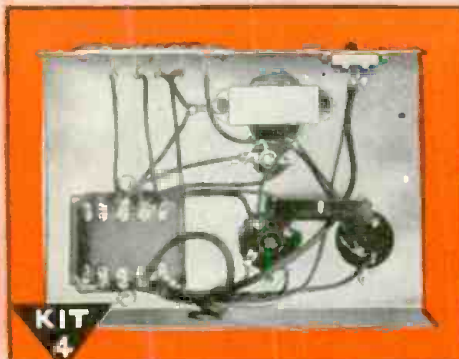

KIT 4
You get parts to build this Vacuum Tube Power Pack; make changes which give you experience with packs of many kinds; learn to correct power pack troubles.



KIT 5
Building this A. M. Signal Generator gives you more valuable experience. It provides amplitude-modulated signals for many tests and experiments.



KIT 6
You build this Superheterodyne Receiver which brings in local and distant stations—and gives you more experience to help you win success in Radio.

I Will Train You at Home - SAMPLE LESSON FREE

Do you want a good-pay job in Radio—or your own money-making Radio Shop? Mail Coupon for a FREE Sample Lesson and my FREE 64-page book, "How to Be a Success in RADIO—Television, Electronics." See how N.R.I. gives you practical Radio experience at home—building, testing, repairing Radios with BIG KITS OF PARTS I send!

Many Beginners Soon Make Good Extra Money In Spare Time While Learning

The day you enroll I start sending EXTRA MONEY JOB SHEETS. You LEARN Radio principles from my easy-to-grasp, illustrated lessons—PRACTICE what you learn with parts I send—USE your knowledge to make EXTRA money fixing neighbors' Radios in spare time while still learning! From here it's a short step to your own full-time Radio Shop or a good Radio job!

VETERANS
You can get this training right in your own home under G. I. Bill.
Mail coupon for full details.

Future for Trained Men Is Bright in Radio, Television, Electronics

It's probably easier to get started in Radio now than ever before because the Radio Repair business is booming. Trained Radio Technicians also find profitable opportunities in Police, Aviation, Marine Radio, Broadcasting, Radio Manufacturing, Public Address work. Think of even greater opportunities as Television and Electronics become available to the public! Send for free books now!

Find Out What N.R.I. Can Do for You

Mail Coupon for Sample Lesson and my 64-page book. Read the details about my Course. Read letters from men I trained, telling what they are doing, earning. See how quickly, easily you can get started. No obligation! Just MAIL COUPON NOW in an envelope or paste it on a penny postal. J. E. SMITH, President, Dept. 7HX, National Radio Institute, Pioneer Home Study Radio School, Washington 9, D. C.

Our 33rd Year of Training Men for Success in Radio
My training includes TELEVISION • ELECTRONICS • F M

Good for Both - FREE

Mr. J. E. SMITH, President, Dept. 7HX
National Radio Institute, Washington 9, D. C.

Mail me FREE, without obligation, Sample Lesson and 64-page book about how to win success in Radio and Television—Electronics. (No salesman will call. Please write plainly.)

Age

Name

Address

City State

(Please include Post Office zone number)

APPROVED FOR TRAINING UNDER GI BILL



RCA Miniature Tubes enhance the tonal brilliance of RCA Victor Globe Trotter portable radios.

She shall have music wherever she goes!

Wherever you go with an RCA Victor Globe Trotter portable radio you'll enjoy richness and clarity of tone—volume enough for outdoor dancing—made possible through tiny tubes.

Miniature tubes save valuable space in small radios—space that can be used for larger and better loudspeakers and for longer lasting, radio-engineered RCA batteries.

These miniature tubes were developed by RCA Laboratories—a world center of radio and electronic research—and long a leader in development of electron tubes for all purposes.

At RCA Laboratories, the same research, experimentation and advancement that resulted in these improved tubes, keep all RCA products and services at the top in their particular fields.

When you buy a product bearing the name RCA or RCA Victor—a radio set, television receiver, Victrola radio-phonograph, a radio tube or phonograph record—you get one of the finest products of its kind that science has yet achieved.

"Victrola" T. M. Reg. U. S. Pat. Off.

Radio Corporation of America, RCA Building, Radio City, New York 20. Listen to the RCA Victor Show, Sundays, 2:00 P.M., Eastern Daylight Saving Time, over NBC.

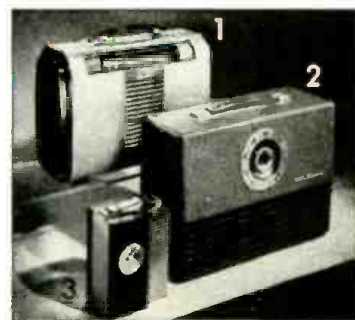

Ideal traveling companions. (1) RCA Victor "Globe Trotter" portable radio—operates on AC, DC, or batteries. (2) RCA Victor "Escort"—has a battery you can recharge from any ordinary AC electric outlet. (3) RCA Victor "Solitaire"—less than 6¼ inches tall!



RADIO CORPORATION of AMERICA

Will your soldering iron support a new home ?

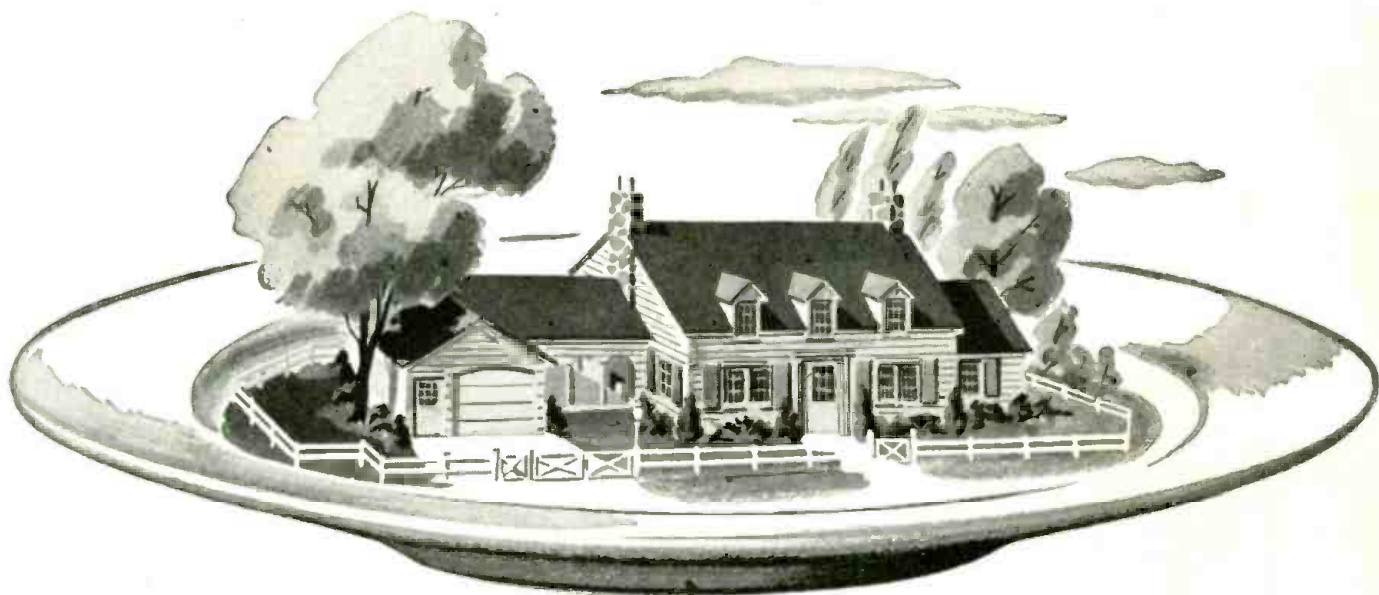

Yes!

We don't blame you or any radio technician for wanting a new home only you can't get it by wishing. You can with your soldering iron. Every electronic device you service requires the use of your soldering iron. Therefore, anything that gives you more time behind your soldering iron means more cash for you.

NEW BOOKLET FULL OF MONEY-MAKING IDEAS

What can you do to make more money? This question is answered by a straight-shooting booklet called "Keep Your Iron In The Fire", part of a complete service-sales program initiated by IRC in the interest of servicemen. Ask your IRC Distributor for your copy . . . today. International Resistance Company, 401 N. Broad Street, Philadelphia 8, Pennsylvania. In Canada: International Resistance Company, Ltd., Toronto, Licensee.

HOT TIP* Canvass your locality for service business with a postcard mailing. Business reply mailing pieces are available through your IRC Distributor . . . 2 colors, imprinted with your name and address.

*From "Keep Your Iron In The Fire"

INTERNATIONAL RESISTANCE COMPANY

IRC

Wherever the Circuit says Ω

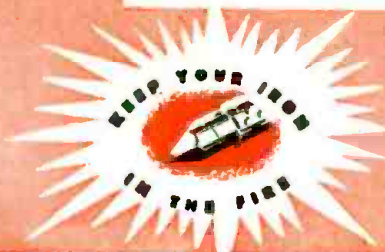

**"I find by comparison
there is no comparison—**

**PHOTOFACT* is
by far superior
in all ways"**

—E. S. Worthington, Jr.
Maplewood, Missouri
(In Radio Servicing Since 1929)

Hundreds of OLD TIME Radio Service Men have made the same comparison, and like Mr. Worthington they've found helpful, time saving, profit making, exclusive advantages in PHOTOFACT that no other service can provide.

It's like trying to compare an encyclopedia with a dictionary.

Make the test for yourself.

**You'll find these EXCLUSIVE
PHOTOFACT ADVANTAGES**

● **MOST ACCURATE**

Based on study of the actual equipment in our own laboratories.

● **MOST COMPLETE**

Gives you all the data you need.

● **MOST UNIFORM**

Data is always in the same place—easiest for fast reference.

● **DIAL CORD DRAWINGS**

For EVERY receiver.

● **PRODUCTION CHANGES**

The only service that is always up-to-date.

● **CODED SCHEMATICS**

For every receiver, keyed to complete parts lists and photographs.

● **PHOTOGRAPHS**

Top—bottom and other views of EVERY instrument—LARGE—CLEAR with each part coded.

*Reg. U. S. Pat. Off.

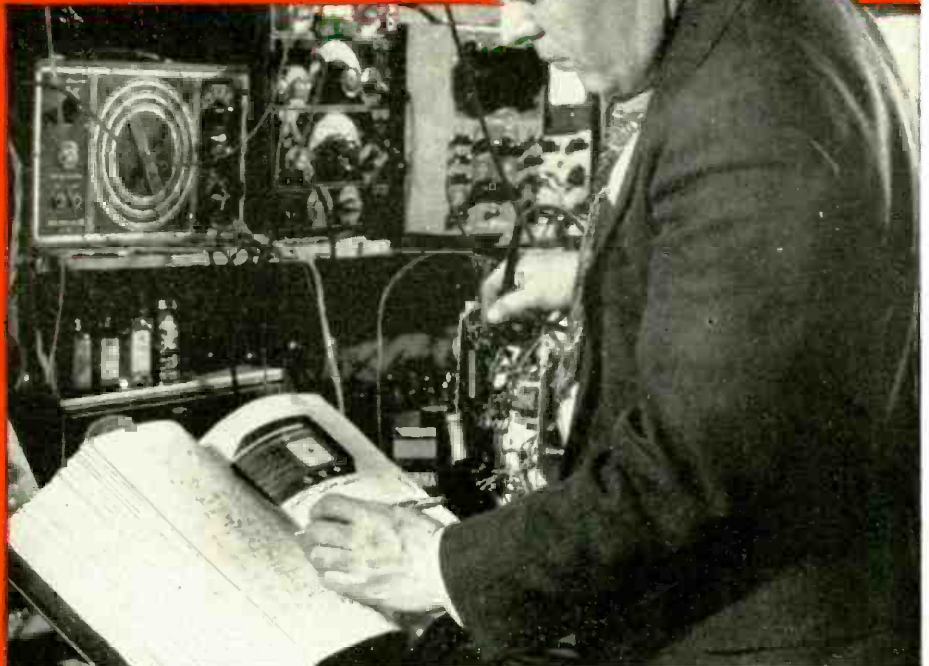

Ask to see PHOTOFACT VOLUMES I and II. Notice these points. The same complete data always in the same easy-to-find location! BIG, CLEAR, ACCURATE PICTURES—each with its simple coding system—keyed for instant reference to complete parts lists. Full alignment and circuit data! DISASSEMBLY INSTRUCTIONS! DIAL CORD DRAW-

INGS! And even RECORD CHANGERS are completely diagrammed.

Put any other service beside PHOTOFACT and compare. Use PHOTOFACTS once—you'll use them forever.

Individual Set #21—available July 15 at the same low cost of \$1.50. Order Volumes I and II and the current set from your nearest distributor, or mail directly to us.

**COMPARE . . . and You'll Buy PHOTOFACT
HOWARD W. SAMS & CO., INC.**

INDIANAPOLIS 6, INDIANA

Export—Ad. Auriema—89 Broad St., New York 4, N. Y.—U. S. of America

Canada—A. C. Simmonds & Sons, 301 King St. East—Toronto, Ontario

PHOTOFACT SERVICE

"The Service that pays for itself over and over again"

HOWARD W. SAMS & CO., INC.
Indianapolis 6, Indiana

My (check) (money order) is enclosed.

Send _____

Name _____

Address _____

City _____ State _____

PHOTOFACTS are based on OUR actual study of the equipment covered. We ORIGINATE information—WE DO NOT COPY IT. Every fact is quadruple checked for accuracy. NO OTHER SERVICE COMPARES WITH PHOTOFACT.

PHOTOFACT VOLUMES I and II—the first 20 sets of PHOTOFACT Folders—are now available. Think of it! Almost 3800 pages, covering approximately 1800 NEW 1946 and 1947 models and chassis designations—yours for only \$18.39 for each volume. If you prefer drawer filing, order any or all of the 20 individual sets of folders at \$1.50 per set. Less than two cents a model brings you this complete, up-to-the-minute service.



NOW! An Amazing Opportunity to LEARN RADIO AT HOME

I SEND YOU 8 BIG KITS OF RADIO PARTS

Including a **COMPLETE 6 TUBE SUPER-METERODYNE RECEIVER**

**I TRAIN YOU
RIGHT by PUTTING
YOU TO WORK with
REAL PROFESSIONAL
EQUIPMENT!**

LEARN HOW TO BUILD CIRCUITS! TEST! REPAIR!
YOU DO OVER 175 INSTRUCTIVE EXPERIMENTS

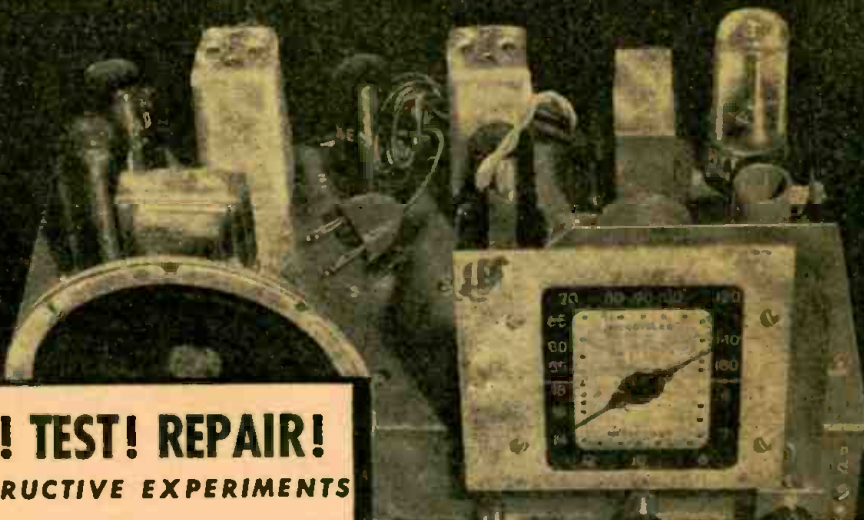

**HERE'S THE EASIEST, MOST PRACTICAL WAY OF ALL TO PREPARE
FOR GOOD PAY in RADIO ELECTRONICS and TELEVISION!**

I train your mind by putting you to work with your hands on a big 6-Tube Superheterodyne Receiver. And, believe me, when you get busy with real Radio Parts — 8 big Kits of them — you really LEARN Radio and learn it RIGHT! You get the practical stuff you need to be useful in Radio, and that's what it takes to make money. You don't have to worry about what to do with these 8 Kits of Parts. Step by step, I show you how to build circuits, test, experiment, trouble-shoot. And you don't need any previous experience. The Sprayberry Course starts right at the beginning of Radio. You can't get lost! Simplified lessons, coupled with real "Shop" practice, makes every subject plain and easy to understand and remember. Soon after you begin Sprayberry Training, I'll send you my sensational BUSINESS BUILDERS.

A BUSINESS OF YOUR OWN . . . OR A GOOD RADIO JOB
You'll find out how to get and do neighborhood Radio repair jobs for nice profits and rich experience while learning. This sort of work can easily pave the way for a Radio Service business of your own. But with Sprayberry Training, you're not limited. You can swing into any one of the swiftly expanding branches of Radio-Electronics INCLUDING Radio, Television, FM, Radar, Industrial Electronics. Be wise! Decide now to become a fully qualified RADIO - ELECTRONICIAN. Get full details about my Training at once! Mail coupon below for my 2 big FREE Books.

**YOU BUILD THIS USEFUL
TEST EQUIPMENT!**



I give you a fine, moving-coil type Meter Instrument on Jewel Bearings — with parts for a complete Analyzer Circuit Continuity Tester. You learn how to check and correct Receiver defects with professional accuracy and speed.



You'll get valuable experience and practice building this Signal Generator and Multi-purpose Tester. Makes a breeze out of fixing Radios and you don't have to spend money on outside, ready-made equipment.

Soldering, wiring, connecting Radio parts . . . building circuits — you can't beat this method of learning. When you construct this Rectifier and Filter, Resistor and Condenser Tester, etc., you get a really practical slant on Radio.



RUSH COUPON!

SPRAYBERRY ACADEMY OF RADIO
F. L. Sprayberry, President, Room 2087, Pueblo, Colorado
Please rush my FREE copies of "How to MAKE MONEY in RADIO, ELECTRONICS and TELEVISION," and "HOW to READ RADIO DIAGRAMS and SYMBOLS."

Name Age

Address

City State

(Mail in envelope or paste on penny postcard)

**GET THESE VALUABLE
FREE BOOKS**

"How to Read Radio Diagrams and Symbols"

Here's a valuable and wonderfully complete new book which explains in simple English how to read and understand any Radio Set Diagram. Includes translation of all Radio symbols. Send for this volume at once. It's free! Along with it, I will send you another Big Free book describing in detail my Radio-Electronic Training.

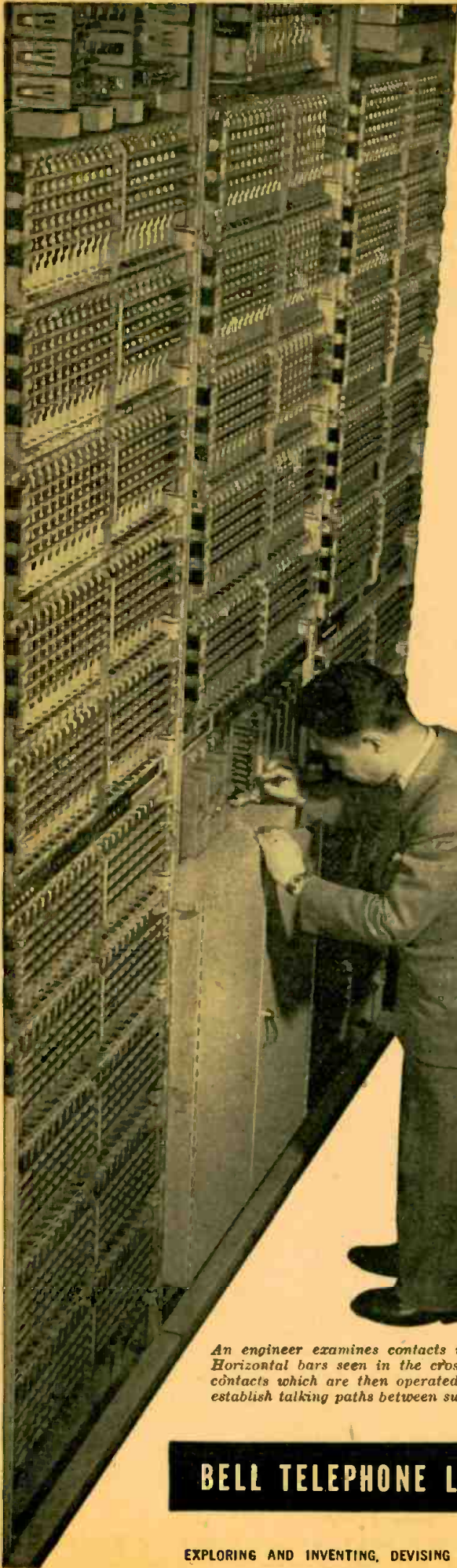

An engineer examines contacts in a crossbar office. Horizontal bars seen in the crossbar switches select contacts which are then operated by vertical bars to establish talking paths between subscribers.

A BILLION ORDERS A DAY

In a large modern telephone office 2,000,000 switch contacts await the orders of your dial to clear a path for your voice. They open and close a billion times a day.

At first, contacts were of platinum—highly resistant to heat and corrosion but costly. Years ago, Bell Laboratories scientists began looking elsewhere, explored the contact properties of other precious metals—gold, silver, palladium and their alloys—and with the Western Electric Company, manufacturing unit of the Bell System, restudied shape, size and method of attachment.

Outcome of this long research is a bar-shaped contact welded to the switch

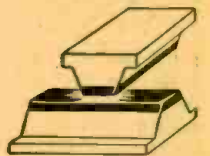

and positioned at right angles to its mate. For most applications, an inexpensive base is capped with precious metal.

Savings from these contacts help keep down the cost of telephone service. This is but one example of how Bell Laboratories serve the public through your Bell Telephone Company.

BELL TELEPHONE LABORATORIES



EXPLORING AND INVENTING, DEVISING AND PERFECTING, FOR CONTINUED IMPROVEMENTS AND ECONOMIES IN TELEPHONE SERVICE

RADIO-CRAFT for AUGUST, 1947

RADIO and ELECTRONICS offers YOU...

REAL MONEY, REAL JOB, AND REAL INDEPENDENCE

FOLLOW THE ADVICE OF THE MASTERS

PREPARE *today* SUCCEED *tomorrow*

Make good money . . . get a real job . . . be independent by owning your own business . . . follow the advice of the masters . . . "PREPARE TODAY TO SUCCEED TOMORROW."

Whether you are an ex-G.I., a teen-age youth or an older man, few other fields offer you such a vast variety of opportunities for real money and a brighter future as the colorful, fascinating field of RADIO and ELECTRONICS.

Get Late Facts

Use the coupon below! Get the late facts about the exciting news in F.M. Radio, Broadcast Radio, Television, Electronics, Radar, 2-Way Train Radio, Sound Motion Picture Equipment, Sound Recording — and other fast-moving branches of this field.

15 Years Experience In Training Men

Also see how readily YOU can prepare to enter the field of Radio and Electronics by means of the remarkably effective courses and Employment Help of DeForest's Training, Inc. that have been getting results for over 15 years.

DeForest's Training, Inc. is the first school of its kind ever to receive the CERTIFICATE OF MERIT of the New York Museum of Science and Industry. It won this award for the efficiency and thoroughness of its courses.

Prepare now for a job in Radio, Electronics and Communications, by attending RESIDENT LABORATORY courses in Chicago, or in your spare time at home. DeForest's Training, Inc. offers you these 4 BIG HOME TRAINING ADVANTAGES:

- (1) We supply you with a 16 Mm. motion picture machine with 12 reels of fact-packed information;
- (2) Illustrated loose-leaf lessons with handy fold-out diagrams;
- (3) 8 big commercial-type Radio Electronic Kits of assemblies and parts, from which you may work out more than 133 modern experiments including 7 different types of radio receivers at home; and
- (4) After you complete your training, you get the benefit of our effective employment service.

YOU NEED NO PREVIOUS ELECTRICAL OR RADIO EXPERIENCE

If you prefer, you can get ALL of your Training in our—

NEW CHICAGO LABORATORIES

. . . offering you some of the finest Radio-Electronic Training Facilities in the nation. Enjoy many post-war training advantages in a modern, new building, housing a wealth of "LEARN-BY-DOING" Equipment. Visitors invited.



VETERANS!!

Both the Home Study and Chicago laboratory courses of DeForest's Training, Inc. are accepted for your training. If you qualify under the "G. I. Law," you can obtain this training without cost.

DeFOREST'S TRAINING, INC.

2533-41 N. ASHLAND AVE.

CHICAGO, ILLINOIS

Affiliated with DeVry Corporation, Chicago

DeFOREST'S TRAINING, INC.
2533-41 N. Ashland Ave., Dept. R.C.—D 8
Chicago 14, Illinois, U.S.A.

Send me your big book "VICTORY FOR YOU", showing how I may make my start in Radio-Electronics with our modern home training plan. No obligation.

Name Age

Address Apt.

City Zone State

If under 16, check here If a discharged veteran of
for special information. World War II, check here.



SERVICEMEN

Check This Column for Lowest Prices on Quality Parts

TUBES: all types in stock, 60% off on all tubes if ordered in lots of 10 or more.

TRANSFORMERS—All types in stock. **AUTO-TRANSFORMERS:** Steps up 110v to 220v, or steps down 220v to 110v—\$1.95. **FIL. TRANS.:** 6.3v, 8 Amps.—\$1.98; 5v, 10 Amps.—\$1.98; Universal Output Trans. 8 Watt—89c; 18 Watt—\$1.29; 30 Watt

\$1.69. AUDIO TRANSFORMERS: S. Plate to S. Grid. 3:1—79c; S. Plate to P.P. Grids—79c; Heavy Duty Class AB or B. P.P. Input—\$1.49; Midset Output for AC-DC sets—69c; **MIKE TRANSFORMER** for T-17 Shure microphone, similar to UTC ounce type—\$2.00.

POWER TRANSFORMERS—Half-shell type, 110V, 60 cy, Centertapped HV winding. Specify either 2.5 or 6.3V filament when ordering.

For 4-5 tube sets—650V, 40MA. 5V & 2.5 or 6.3V.....\$1.49
For 5-6 tube sets—650V, 45MA. 5V & 2.5 or 6.3V.....1.75
For 6-7 tube sets—675V, 50MA. 5V & 2.5 or 6.3V.....1.90
For 7-8 tube sets—700V, 70MA. 5V & 6.3 or two 2.5V.....2.35
For 8-9 tube sets—700V-90MA, 5V-3A, 2.5V-3.5A.....2.85

For 9-11 tube sets—700V, 100MA. 5V & 6.3V-4A.....2.85
For 9-15 tube sets—600V, 150MA. 5V & 6.3V.....2.95

CONDENSERS—PAPER TUBULAR 600 WV.—.001, .002, .005—8c; .01, .05—9c; .1—10c; .2—23c; .5—36c; **ELECTROLYTICS:** 8mfd 200v—20c; 10mfd 35v—20c; 30mfd 150v—23c; 20/20mfd 150v—35c; 30/20 150v—46c; 50mfd 150v—43c; 8mfd 475v—34c; 16mfd 350v—65c; **OIL CONDENSERS:** 4mfd 600v

40c; **BATH TUB TYPE CONDENSERS:** 3X.1mfd—20c; **RESISTORS:** All types in stock at the lowest prices; Resistor Kits: 100 2 watt resistors—\$1.95.

FILTER CHOKES: 200, 300, 400, 500 ohm light duty—59c; 200 or 300 ohm heavy duty—99c; 250 ma 35 ohm, made for U.S. Navy, fully shielded—\$1.95; 75 ohm 125 ma—25c or 25 for \$4.25; "Hefelsner type" tapped filter chokes—25c; 8 amp. iron core A filter—25c; Choke-condenser combination, ideal to replace any size speaker field when installing PM speakers—79c.

110 V. CIRCUIT BREAKERS of Magnetic type: Following Current Ratings in Stock: 1.25, 3, 4, 8 Amps. Please specify. \$1.95 each. Seven Assorted I.F. Transformers—\$1.98; Five Ass'd. Oscillator Coils—69c.

SPEAKERS—PM dynamic type—4"—\$1.55; 5" \$1.55; 6" \$1.95; 8" \$3.95; 10" \$5.95; 12" \$7.50.

HEADPHONES—Highest quality Signal Corps headsets with 12' cord and plug \$1.25. 3' rubber covered patchords with phone plug and socket—45c.

SELENIUM RECTIFIERS—Dry disc type 1 1/2" by 1" 1.2 Amp. maximum, suitable for converting DC relays to AC, for supplying filament source in portable radios, converting DC meters to AC applications, and also may be used in low current chargers—90c.

METER RECTIFIERS—Full wave, may be used for replacement, or in construction of all types of test equipment—\$1.25. Half Wave—90c.

LINE FILTERS—110V—each unit contains two 2 mfd. oil filled condensers and a 15 amp. iron core choke. This filter has innumerable uses such as oil burner line filter, etc. A ten dollar value for 98c.

WILLARD rechargeable 2v storage batteries for portable radios or any other purpose—\$2.95.

PUBLIC ADDRESS AMPLIFIERS—25 watts peak output. This unit has separate input circuits for microphone and phono. The gain of the microphone circuit is 122db. The phono circuit has a gain of 82db. The frequency response is flat from 50 to 12,000 cycles. A \$65 value for only \$32.

Miniature pillers set contains one of each of the following: Needle nose, flat nose, Parrot nose, standard nose. All contained in a leatherette case. Your cost—\$1.96.

ATR battery eliminator—Handy for servicing car radios or any other purpose requiring 6 or 12v at 14 amps. Net price—\$36.

SOCKET WRENCH SET consisting of 5 sockets ranging in size from 9/16 to 3/4" and a handle—79c.

AUTOMATIC WIRE STRIPPERS will strip up to 1000 wires per hour, a handy tool for any service job—\$3.52.

Six Foot Asbestos Insulated Flat Iron Cord, one end has a male plug, the other end has a standard flat iron socket. Your price—70c each or 10 for \$5.

SPECIAL! THIS MONTH ONLY.

A FREE CRYSTAL PICK-UP WITH THE PURCHASE OF EACH PHONO MOTOR AT \$4.95.



MICROPHONES—All nationally known brands. Bullet crystal—\$5.45; Bullet Dynamic—\$7.45; Mike Jr.—60c; Handy Mike—90c; Lapel Mike—93c; SHURE T-17 MIKES, with push to talk switch—99c.

20 ASS'D COIL FORMS, including 11 ceramic, 3 polystyrene, and 6 fiber, all useful sizes—50c.

VARIABLE CONDENSERS: 350 MMFD, 5 gang—\$1.95; 4 gang—\$1.49; 3 gang—85c; 2 gang—79c; 7.5 to 20 MMFD, 1750v spacing, extra long shaft—Hammarlund—69c; miniature variables, 25 MMFD—39c; 50 MMFD—49c; 75 MMFD—59c; 100 MMFD—69c; 140 MMFD—79c.

TRANSMITTING RF CHOKES, 4 PIE. 350 Ma.—25c or 5 for \$1.00.

INTERRUPTION FREQUENCY COILS for super-regenerative receivers or the tremendously popular FM adapters for standard broadcast sets. Iron core with a resonant frequency of 50 KC—39c; Air Core, 100 KC—29c.

30 MC IF TRANSFORMERS, double slug tuned—25c.

VIDEO AMPLIFIER PLATE COILS, slug tuned—25c.

REMOTE CONTROL UNIT: Aluminum case 4x3x2" containing 2 potentiometers, triple pole switch, 4 knobs, gear mechanism, counter and phone jacks—59c.

MODULATION TRANSFORMERS—10 watt, metal case 98c; 30 watt, open-type, \$1.95; 40 watt, cast aluminum case, \$2.95; Class "B" input transformers, cast aluminum case, \$1.95; Transceiver audio transformers, 65c; Transceiver modulation transformers, 65c.

GENERAL ELECTRIC RT-1248 15-TUBE TRANSMITTER-RECEIVER

TERRIFIC POWER—(20 watts) on any two instantly selected, easily pre-adjusted frequencies from 435 to 500 Mc. Transmitter uses 5 tubes including a Western Electric 316 A as final. Receiver uses 10 tubes including 955's, as first detector and oscillator, and 3-7H7's as IF's, with 4 slug-tuned 40 Mc. IF transformers, plus a 7H7, 7E6's and 7F7's. In addition unit contains 8 relays designed to operate any sort of external equipment when actuated by a received signal from a similar set elsewhere. Originally designed for 12 volt operation, power supply is not included, as it is a cinch for any amateur to connect this unit for 110V AC, using any supply capable of 400V DC at 135 MA. The ideal unit for use in mobile or stationary service in the Citizen's Radio Telephone Band where no license is necessary. Instructions and diagrams supplied for running the RT-1248 transmitter on either code or voice, in AM or FM transmission or reception, for use as a mobile public address system, as an 80 to 110 Mc. FM broadcast receiver, as a Facsimile transmitter or receiver, as an amateur television transmitter or receiver, for remote control relay hook-ups, for Geiger-Mueller counter applications. It sells for only \$29.95 or two for \$53.90. If desired for marine or mobile use, the dynamotor which will work on either 12 or 24V DC and supply all power for the set is only \$15.00 additional.

ARMY BC-312 COMMUNICATIONS RECEIVER

This receiver covers the frequency range of 1.5 MC to 18 MC in six direct reading bands. The dial, that is driven with split gears to prevent backlash, has 4500 logging divisions per band with approximately 600 divisions on the 20 and 40 meter ham bands and 1000 divisions on 80 meters. Two stages of RF before the converter in this set give it a very high signal to noise ratio and maximum sensitivity. Outstanding features of this receiver are: BFO with pitch control, send-receive relay, jacks on the front panel for headphones and speaker output, and mike and key inputs. All tubes are standard 6 volt types. This receiver was designed to withstand rough usage in the field and for operation from vehicles while in motion, so it is ruggedly constructed and contains a dynamotor power supply—Your cost—\$49.95. Conversion kit to 110 VAC is available for ... \$6.50

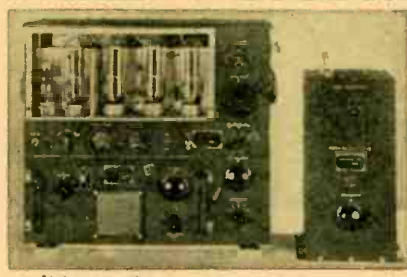

GENERAL ELECTRIC 150 WATT TRANSMITTER

**Cost the Government \$1800.00
Cost to you \$44.50!!!!**

This is the famous transmitter used in U.S. Army bombers and ground stations, during the war. Its design and construction have been proved in service, under all kinds of conditions, all over the world. The entire frequency range is covered by means of plug-in tuning units which are included. Each tuning unit has its own oscillator and power amplifier coils and condensers, and antenna tuning circuits—all designed to operate at top efficiency within its particular frequency range. Transmitter and accessories are finished in black crackle, and the milliammeter, voltmeter, and RF ammeter are mounted on the front panel. Here are the specifications: **FREQUENCY RANGE:** 200 to 500 KC and 1500 to 12,500 KC. (Will operate on 10 and 20 meter band with slight modification). **OSCILLATOR:** Self-excited, thermo compensated, and hand calibrated. **POWER AMPLIFIER:** Neutralized class "C" stage, using 211 tube, and equipped with antenna coupling circuit which matches practically any length antenna. **MODULATOR:** Class "B"—uses two 211 tubes. **POWER SUPPLY:** Supplied complete with dynamotor which furnishes 1000V at 350 MA. Complete instructions are furnished to operate set from 110V AC. **SIZE:** 21 1/2 x 23 x 9 1/4 inches. Total shipping weight 200 lbs., complete with all tubes, dynamotor power supply, five tuning units, antenna tuning unit and the essential plugs. These units have been removed from unused aircraft but are guaranteed to be in perfect condition.

6-BAND COMMUNICATIONS RECEIVER BC-348

Featuring coverage from 200 to 500 Kc. and 1500 to 18000 Kc. on a direct reading dial with the finest vernier drive to be found on any radio at any price—high sensitivity with a high degree of stability—crystal filter—BFO with pitch control—standard 6 volt tubes. Contains a plate supply dynamotor in compartment within the handsome black crackle finish cabinet, the removal of which leaves plenty of room for installation of a 110V, 25 or 60 cycle power supply. These receivers, which make any civilian communications receiver priced under \$200.00 look cheap and shabby by comparison, are only \$44.50. Power supply kit for conversion to 110V, 25 or 60 cycle, is only \$8.50 additional.

AIRCRAFT AMPLIFIER C1—This unit is housed in an aluminum case that is 9x8x7 inches and contains 1-7Y4, 3-7N7, 3-7F7 and six 5000 ohm sensitive relays. This unit is brand new and in its original packing 9.95

BC-654 TRANSMITTER-RECEIVER—Brand NEW with 17 tubes, key, microphone and calibrating crystal \$39.95

BENDIX SCR 522—Very High Frequency Voice Transmitter-Receiver—100 to 156 MC. This job was good enough for the Joint Command to make it standard equipment in everything that flew, even though each set cost the Gov't. \$2500.00. Crystal Controlled and Amplitude Modulated—HIGH TRANSMITTER OUTPUT and 3 Microvolt Receiver Sensitivity gave good communication up to 180 miles at high altitudes. Receiver has ten tubes and transmitter has seven tubes, including two 832's. Furnished complete with 17 tubes, remote control unit, 4 crystals, 24 volt dynamotor and the special wide band VHF antenna that was designed for this set. These sets have been removed from unused aircraft and are guaranteed to be in perfect condition. We include free parts and diagrams for the conversion to "continuously-variable frequency coverage" in the receiver. The cost of this unit is only \$37.95. A brand new 12V. 522 dynamotor is available for \$3.00 additional with the purchase of a 522, or separately for \$15.00.

C-144 TRANSMITTER, 2 type 826 tubes as oscillator in lecher line tuning circuit that resonates between 150 and 200 megacycles contains 3 DC power supplies that operate from 110v 60 cycles. This unit is easily converted to the 2 meter ham band, may be neutralized and operated as a high power final amplifier. Your cost—\$49.95.

Minimum order \$3.00 — All prices subject to change — 25% deposit with COD orders.

MAKE MORE MONEY

IN Radio TELEVISION & ELECTRONICS

Now!

GET THESE 2 BIG BOOKS

FREE!

You men already in Radio know how great the demand is for trained, experienced servicemen, operators and technicians. You know how fast the field is growing and how important it is to keep up with developments—F.M. Receivers, Electronics and Television. You know, too, a fellow cannot learn too much about any industry for **REAL SUCCESS**. Whether you have experience or are merely **INTERESTED** in radio as an amateur, you must recognize the **WONDERFUL OPPORTUNITY** right within your grasp to cash in on your natural abilities. Make them pay dividends. Get into the **EXPERT RADIO SERVICE FIELD**. Be an **F.M. and TELEVISION specialist—OWN A BUSINESS OF YOUR OWN**, if you prefer. Fill out and mail the coupon below for all the details of our plan.

Get the Latest Inside Information—Short Cuts—Trade Secrets by

Here's Just a Few of the Interesting Facts you Learn with the **FREE MANUAL**.

1. Routine for diagnosing Radio Troubles.
2. Preliminary Inspection of Receivers.
3. How to Check Power Supply.
4. How to Identify Various Stages of Receiver.
5. How to Trace the Circuit and Prepare Skeleton Diagram.
6. How to Test and Measure Voltages.
7. How to Test Speaker in Audio Stages.
8. How to Test Detector, I.F., R.F. and Mixer Stages.
9. Complete Reference Table for Quickly Locating Receiver Troubles.



SHOP METHOD HOME TRAINING

FROM A REAL ESTABLISHED RESIDENT SCHOOL

Now the famous National Schools brings its exclusive Shop-Method of training right into your own home. You can learn the most up-to-date, approved projects, systems and circuits step by step in your spare time. This is the sound and practical training you want and need—the development of experienced instructors working with thousands of students right in shops, **NEW F.M. broadcast studios and experimental laboratories of NATIONAL SCHOOLS**—one of the most advanced trade educational centers in the world.



LEARN BY DOING

Work with Real Experimental Equipment Furnished without Extra Cost as Part of Your National Training

Experience is the best teacher. You learn by experience with the exclusive National Shop-Method of Home Training. In the course of your study you actually build various types of receivers—a powerful superheterodyne, a signal generator, an audio oscillator and others—You make tests and conduct experiments that show you the why and how of things. You understand what makes the various elements of electronics operate because you actually see them work for you. Not only do you gain marvelous experience by this method of learning but you receive valuable equipment you will use on the job in the practice of your profession as an electronics expert. Mail the coupon and learn what this means to you.

Send the Coupon and prove to yourself what YOU can do in RADIO!

VETERANS

If you qualify for training under G. I. Bill, check the coupon for a Special Bulletin.



Be Sure Of Your Success And Security

Don't let your post-war ambitions lag. Don't let YOUR future depend on others. Build a career for yourself. Never in all history have there been such great futures in Radio, Television and Electronics. Here is a new world opening before you. You can prepare to step into an essential, well paid position or, if you wish, **GET INTO BUSINESS FOR YOURSELF**. Start NOW. Radio men are vitally needed. Fill out and mail the coupon immediately and examine the **NATIONAL SHOP TRAINING METHOD COURSE** carefully, without obligation.

FREE LESSON INCLUDED

Examine the exclusive National Shop Method of Home Training. See for yourself how sound and practical it is. Be convinced that you can learn Radio, Electronics, Television—quickly and easily in your spare time. You can't tell until you try. This trial is **ABSOLUTELY FREE**. Fill out the coupon immediately while you are thinking about it and drop it in the mail at once. Mail the coupon here for the books that tell you the complete story of the marvelous new system of training in Radio, Electronics and Television. Learn the facts of this exclusive shop-method of home training. See for yourself **DECIDE FOR YOURSELF!** This is the **MODERN SYSTEM OF TRAINING**. It matches the rapid progress constantly being made in Radio, Television and Electronics. It is **TIME TESTED**, too. National Schools has been training men for more than a third of a century. It is the very same training that has helped thousands to more pay and greater opportunity. You owe it to yourself—your future—to read the book "Your Future in Radio, Electronics and Television"—**FREE** to you when you send in the coupon.

NATIONAL SCHOOLS

LOS ANGELES 37, CALIFORNIA EST. 1905



MAIL OPPORTUNITY COUPON FOR QUICK ACTION

National Schools, Dept. 8-RC
4000 South Figueroa Street, Los Angeles 37, California.

(Mail in envelope or paste on penny post card)

Mail me **FREE** the two books mentioned in your ad, including a sample lesson of your course. I understand no salesman will call on me.

NAME AGE

ADDRESS

CITY ZONE STATE

Check here if Veteran of World War II.

Editorial: FM Boom	by Hugo Gernsback	17
Radio-Electronics Monthly Review		18
"Churchilka" Beat Nazis		53

Electronics

Electronic Counting	by Jordan McQuay	26
Miller-Effect FM	by Harold E. Ennes	35
Airborne Metal Seeker		73

Amateur Radio

Ham Antenna Tower for V.H.F. and U.H.F. (Cover Story)	by Bill Hoisington, W2BAV	22
250-Watt FM-AM Transmitter	by Harry D. Hooton, W3KPX	28
Part II—Construction of the r.f. section		

Servicing

Radio Set and Service Review (Some Novel Postwar Models)		24
Quick Fault Finding	by H. E. Leeper	29
Dealer Service Builds Volume	by Jack Tannehill	30
Oscillators	by Jack King	31
A Soldering Gun	by Ral Collins	48

Sound

Portable Recorder-Player	by Joseph G. Karnath, W2RRA	20
Audio Oscillator with Band Spread	by C. F. van L. Weiland	23
Part I—General Design Considerations		
Ultrasonic Principles and Circuits	by J. W. Straede	34
Miniature-Tube Amplifier	by J. Carlisle Hoadley	54
Volume Expander	John Kwietniskas	67

Test Instruments

Compensator for A.C. Meters	by P. Hemardinquer	37
Decade Box for Capacity Tests	by R. L. Parmenter, W1XJF	33
A Volt-ohmmeter Without Switches	by Ralph Bloom	36

Construction

Time Delay Control Circuits	by R. H. Dorf, W2QMI	27
Travellers' 2-Tuber	by Wm. G. Beaman	37
New Superregenerator	by Marion Black	56

Departments

Transatlantic News	by Major Ralph Hallows	38
World-Wide Station List	Edited by Elmer R. Fuller	39
New Radio-Electronic Devices		40
Try This One		42
Radio-Electronic Circuits		44
The Question Box		46
New Radio-Electronic Patents	Conducted by I. Queen	52
Technotes		78
Communications		80
Book Reviews		83

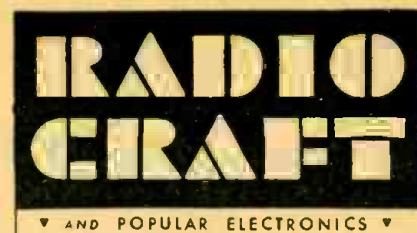

Incorporating
SHORT WAVE CRAFT TELEVISION NEWS
RADIO & TELEVISION

HUGO GERNSBACK

Editor-in-Chief

FRED SHUNAMAN, *Managing Editor*

M. HARVEY GERNSBACK,
Consulting Editor

ROBERT F. SCOTT, W2PWG,
Technical Editor

I. QUEEN, W2OUX, *Editorial Associate*

ELMER FULLER, *Shortwave Editor*

ANGIE PASCALE, *Production Manager*

G. ALIQUO, *Circulation Manager*

JOHN J. LAMSON,
Advertising Director

ALFRED STERN, *Promotion Manager*

In an Early Issue:

SIGNAL INJECTION METHODS
POSTWAR PHONO PICKUPS
A 144-MC TRANSMITTER

On THE COVER:



The multiple-antenna tower of W2BAV. The parabola, actually on the rear corner, is shown at the front for greater clarity.

Chromatone by Alex Schomburg
from photograph by Warren Illes.



Member Audit Bureau of Circulations

RADCRAFT PUBLICATIONS, INC. Hugo Gernsback, President; M. Harvey Gernsback, Vice President; G. Aliquo, Secretary

Contents Copyright, 1947, by Radcraft Publications, Inc. Text and illustrations must not be reproduced without permission of Copyright owners.

RADCRAFT PUBLICATIONS, INC. • PUBLICATION OFFICE 29 Worthington Street, Springfield 3, Mass. • EDITORIAL AND ADVERTISING OFFICES 25 West Broadway, New York 7, N. Y. Telephone REctor 2-9690.

BRANCH ADVERTISING OFFICES: Chicago: 308 W. Washington Street, Suite 1413, Chicago 6, Ill. Tel. Randolph 7363, Cleveland: Burdette Phillips, Manager, 405 Erie Bldg., Cleveland, Ohio, Tel. Main 9645. Detroit: Frank Holstein, Manager, 307-8 Boulevard Bldg., Detroit, Mich. Los Angeles: Ralph W. Harker, Manager, 606 South Hill St., Los Angeles 14, Calif. Tel. Tucker 1793. San Francisco: Ralph W. Harker, Manager, 582 Market St., San Francisco 4, Calif. Tel. Garfield 2481.

RADIO-CRAFT, August, 1947, Volume XVIII, No. 11. Published Monthly on 28th of month preceding date of issue. Allow one month for change of address. When ordering a change, please furnish an address stencil impression from a recent wrapper. All communications about subscriptions should be addressed to the Circulation Manager, Radio-Craft, 25 West Broadway, New York 7, N. Y.

SUBSCRIPTION RATES: United States and possessions, Mexico, Central and South American countries, \$2.50 a year; \$4.00 for two years; \$6.00 for three years. Canada, \$3.00 a year; \$5.00 for two years; \$7.50 for three years. All other foreign countries, \$3.25 a year \$5.50 for two years; \$8.25 for three years. Special rates for members of the Armed Forces in U.S., or those addressed by A.P.O. or F.P.O. mail, \$2.00. Entered at Post Office, Springfield, Mass., as second-class matter under the Act of March 3, 1879.

FOREIGN AGENTS: Great Britain: Atlas Publishing and Distributing Co., Ltd., 18 Bride Lane, Fleet St., London E.C.4. Australia: McGill's Agency, 179 Elizabeth Street, Melbourne. France: Brentano's, 37 Avenue de l'Opera, Paris 2e. Holland: Technisch Bureau Van Baerle, Bemelmans & Co., Heemsteedsche, Dreef 124, Heemstede. Greece: International Book & News Agency, 17 Amerikis Street, Athens. So. Africa: Central News Agency, Ltd., Cor. Rissik & Commissioner Sts. Johannesburg; 112 Long Street, Capetown; 369 Smith Street, Durban, Natal. Universal Book Agency, 70 Harrison Street, Johannesburg. Middle East: Stelmatzky Middle East Agency, Jaffa Road, Jerusalem. India: Magazines Distributors, 5 Bombay Mutual Annexe, Gunbow Street, Fort, Bombay 1.

TELEVISION-

**America's Next
Giant Industry?**



Billboard Announcing Telecasts of
Ball Games in Chicago

Today, **RIGHT NOW**, clear and bright pictures of great sports events, as well as other equally interesting programs, are being telecast for the enjoyment of thousands. Television stations in New York, Chicago, Philadelphia, Washington, Detroit, St. Louis and Los Angeles are already operating on regular schedules. Construction has started in several other centers and it is believed that practically every major city in the country will have this wonderful service before the end of 1948.

Who will build, maintain, and operate the new telecast stations? Who will design, produce, install and service the receivers?

Men Must Be Trained for These New Professions

Alert young men with an ambition to grow with television are training now in the greatly enlarged instruction laboratories of American Television, Inc. A wide choice of courses available. Advanced methods and latest obtainable equipment used.

One of Our New Buildings.
Air Conditioned the Year Round.



U. A. Sanabria

Dr. Lee deForest

The Men Who Direct American Television

The instructional quality of training is under the constant personal supervision of two internationally known engineers, Mr. U. A. Sanabria, President and Founder of American Television, Inc. and Dr. Lee deForest, the famed inventor of the radio tube.



FREE PRE-ENTRANCE COURSE

A Short Home Study Television Course is available to qualified war veterans who are considering residence training. This course is free of any charge or obligation. Your success with it will help you to learn your own abilities in television. It will also aid us greatly in qualifying you for residence training. Your acceptance of the Home Study course in no way obligates you to enter our residence school. So we urge you to take advantage at once of the very unusual opportunity it offers.



Approved for Veteran Training Under G. I. Bill of Rights

American Television, Inc.

5050 BROADWAY

CHICAGO 40, ILLINOIS

REQUEST FOR FREE INFORMATION

American Television, Inc., Dept. of Information
5050 Broadway, Chicago 40, Illinois

Please send details of your Television Training.

NAME _____

ADDRESS _____

CITY _____

ZONE _____

STATE _____

I am a veteran

OIL CONDENSERS

Sprague, Aerovox, Cornell-Dubilier

15 mf 220 vdc .600	5-2.5-2.5 mf 600 vdc	.75
vdc CD	7 mf 800 vdc	.90
1 mf 300 vdc	3.5-.5 mf 1000 vdc	1.00
.25	1 mf 1000 vdc	.75
2 mf 300 vdc	1 mf 1000 vdc	.25
.30	2 mf 1000 vdc	.89
4 mf 300 vdc	4 mf 1000 vdc	1.00
.50	4-1.5 mf 1000 vdc	1.00
5-6 mf 400 vdc	10 mf 1000 vdc	1.40
1.05	1 mf 1500 vdc	.95
1 mf 500 vdc GE.	4 mf 1500 vdc	.15
.25	2 mf 660 ac/1000	.85
2 mf 550 vdc	4 mf 1500 vdc	1.29
.25	1-1 mf 2000 vdc	1.00
.25 mf 600 vdc	1 mf 3000 vdc	
.20	1 mf 7500 vdc	12.50
.85 mf 600 vdc	25 mf 20,000 vdc	17.50
.25	25 mmf 1000 dc	1.25
1 mf 600 vdc	1.5 mf 6000 vdc	12.50
.30	4 mf Solar	.50
1.1 mf 7000 vdc	4 WVDC	.49
2.00		
In lots of 50		
1.50		
2 mf 600 vdc		
.35		
5-5 mf 600 vdc Tube		
1.00		
8-8-4 mf 650 vdc SP		
1.45		
6 sect. ceramic stack		
variable 35-460		
mmf 500v		
1.79		
1&.5 mf 2000 vdc		
1.25		
10 mf 600 vdc		
.85		
2mf 1000 vdc		
Sprague		
.50	2 mf 600 vdc CD.	.40

Electrolytic

HIGH VOLTAGE TRANSFORMERS

All primaries 117V. 60C
 Secondaries:
 #5084—1090 V CT and 800V CT @ 250ma. 6.3V @ 1.5A \$ 6.95
 #5114—1500 CT @ 200ma and 5V @ 3A 6.95
 #5054—980V @ 450ma, \$4.95 each; Pair 9.00
 #5190—6180-V @ 200ma 14.75
 #5057—6.3 CT 1A. 5V CT 3A. 5V CT 3A 2.75
 #5104—6.3 V @ 1A. 6.8C @ 1A. 6.3V @ 1A. 2.45
 #5126—5V CT 3A. 5V CT 3A. 5V CT 6A 3.25

CHOKES

Amertran—RMS test 15KV. 1 Hy. .8amp DC. DC resistance 7.5 ohms \$8.95
 8.5 Hy. 125ma. 1780V test 1.45
 Dual: 7Hy. 75ma. 11Hy. 60ma. 1780V test. Raytheon 1.95
 (Conservative Ratings)

2KVA Transformer and choke—115V 50 to 60 cycle input. single phase. Output: 17,000V at 144 mls Amertran. dimensions: 28x29x13 in. \$74.50

HAND GENERATOR

GN35 2.5 amp. at 8v, 100ma at 325 to 865V or 1.25 amp at 10V, 70ma at 380 to 420V...\$3.50
 GN45—Plate and Fil. Supply. Output 500V DC, 140ma and 6V @ 3A. 8"x8"x6" \$4.95

RECTIFIER TRANSFORMER

117VAC input—62V out at 3.5A. Rectify and use with filter and rheostat to run your 6, 12 and 24VDC equipment. \$1.50

ARMY DYNAMOTORS

For that portable summer rig
 DM-21: In 14VDC 3.3A. Out 235VDC 90ma \$2.49
 DM-25: In 12VDC 2.3A. Out 250VDC 50ma 2.49
 DM-34: In 14VDC 2.8A. Out 220VDC 80ma 2.49
 DM-42: In 14VDC. Out 515/1030VDC 215/260ma and 2/8VDC 3.95

TUNING UNITS



Ideal Basis for E.C.O. Rig Has Osc./Final & Ant. Loading Tanks

Tuning units for TCE & GP7 in the following frequencies: A—350 to 800 kes; B—800 to 1500 kes; C—1500 to 3000 kes; D—3000 to 4525 kes; E—4525 to 6500 kes; Contains all coils, etc., for these frequencies. Order by frequency. State your first and second choice \$2.75

From BC191 and 375—contains: coils, chokes, dials, condensers. Range of frequency from 400KC to 12.5MC. State your approximate frequency. Only \$2.75

Relays

Minatures
 SPDT 24VDC .40
 SPST 28VDC .40
 DPDT 28VDC .45
 SPST 100 VAC overload 380/-1800cy .40
 SPDT 110VAC 380/1800cy .40
 Discount on Lots Telephone Relays
 SPDT with cover WE 1.05
 DPST WE 1.05
 Miscellaneous Types
 SPDT 5VDC in can with 5 pr. base .85
 SPDT 115VAC GE, with SPST thermal delay section 1.95
 DPDT 24VDC Allied .75
 DPST Leach antenna relay with SPST section 12 or 24VDC 1.25
 4PDT 24VDC GM .85
 Solenoid contactor 24VDC Leach. Thermal delay. 45 to 60 sec. Edison type 1508 with 4 prong base. 2.95
 SPDT 115 VAC. Leach. 1.00
 SPDT 115 VAC. WE Wheelock type 1.25
 SPDT 115 VAC. Kurman latch type 2.95
 2 Section SPDT 6 VAC WE Wheelock type 1.10

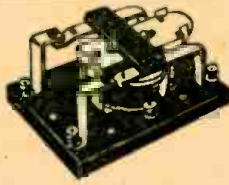

DEPENDABLE EQUIPMENT

"Communications"

LOWEST PRICES

ASSORTED VALUES

Signal Generator, 2700 to 3000Mc. Regulated power supply, 115V, 60C. Contains output meter. Made by Western Electric. Uses GL466 Lighthouse tube. Price \$75.00
 G.E. Magnetometer—Consists of 0-1000 Milligauss meter. Null Indicator Meter, 6 volt dynamotor, neutralizing field control, 5 prong detector receptacle. Adaptable to many applications. Mark 5-Mod 4 designed for underwater and field measurement of electro magnetic flux 70.00
 Silver button mica condensers: 500mmf each \$.10
 Lots of 100 9.50
 Silver button mica condensers: 175-185 .05
 Lots of 100 4.50
 Selsyns—Type 5G 115V, 60C AC Dim: 3 3/4"x5 1/2". Special: a pair 7.75

Technical Manuals

SCR 193—combines Revr 312 and Txmtr 191 (same as 375 .50
 SCR 528, SCR 508, SCR 538, (one manual) .50
 Za-1 Landing equipments .50
 Radio Noise Filter—by Sprague 250 VA. type JX49 .89
 B-29 computer amplifier. Contains 8 6SN7s, 6X5, 5 neons, 8 relays, completely wired with all components and new 9.95

Transmitter Tubes

837 \$1.50 241B \$40.00
 872A 2.98 705A Sockets. .65
 705A 3.95

Cathode Ray Tubes

3BP1 \$3.95 5CP1 \$4.95
 3FP7 2.98 5FP7 3.50
 5BP1 4.95 5JP2 8.95

RM 29

REMOTE CONTROL UNIT



ideal for telephone inter-communication over short distance or several miles. Includes ringer, 2 units with handsets for

2 way communication \$14.00
 or RM-29, each 5.50
 Handsets, each 2.00

SPECIALS

S013 10Cm. Surface Search Radar
 250Kw peak power input to 2J27 magnetron—Trans.-Rec. \$150.00
 Plan Pos. Indicator using 5FP7 100.00
 Spark Gap Modulator, and motor: alternator pwr. unit 75.00
 Rect. Pwr. Unit for rec 25.00
 Rotating Antenna: New 90.00
 Used 45.00
 Send for quotation on complete sets new or used.

Power Pair—Transformer 470V CT @ 60ma; two 6.3V windings @ 1.65A and two 5V @ 2A—Primary: 115V 50 to 1200 Cy. PLUS a 6 Hy. 50ma choke. Both \$1.99
 Feed Thru Insulator—3" cupped shaped pair with flexible whip ant. mtr. Can be used either for feed thru or as whip ant. mast base 2.10
 Antenna Grounding Switch—A MUST FOR EVERY SHACK. Rated 100 amps 2500 volts Silver Ball contacts 2.49
 Vibrator Transformer—Primary: 6, 12 and 24V secondaries: (2) 120V @ 175ma. (1) 11V. Dimensions: 3.25"x3"x3" 1.00

Transmitter-Receivers RC-145 & 148

1KW pulse output on 154 to 186mc. 117 VAC power supply. Can be converted to CW or Voice operation without difficulty, and easily lowered to 144-148mc band. 5 stagger tuned receiver IF stages make for ready adaptability to FM or TV. Can be used as a low power Radar set.

RC-145, NEW, complete with instruction book, including indicator unit \$98.00
 RC-148, used, complete \$47.50

Transmitter BC 375

Air Corps version of the famous BC-191. Used condition. Supplied with one tuning unit. Meters, coils, condensers, etc. Special for quick sale \$9.95

SONAR SOUND DETECTION UNIT

Ideal for detecting underwater sounds, such as fish swimming in schools, within a 15 mile area. Using a Rochelle salt crystal, which is about 1000 times more sensitive than quartz. It is completely enclosed in a solid rubber sheath. This sound detector was originally used in harbor defense. Coupled to an audio amplifier, this can be found to have many valuable applications.

It's the Model JR which contains 7 microphone units for three times as much sensitivity as the SD-1 \$12.50

RG 9U Coax GE, silver coated copper. 51 ohm surge impedance. Sd in 100 ft. lengths and 500 ft. reels at, per ft. .07 1/2

Microwave Tubes MAGNETRONS



3J31 (1cm) \$20.00
 Magnet 6.00
 2J26 (10cm) 25.00
 2J32 (10cm) 25.00
 2J38 (10cm) 25.00
 Magnet 10.00
 709A (L band) 35.00
 720B (S band 1000kw) 20.00
 Magnet 12.50
KLYSTRONS
 2K25/723ab \$7.75
 2C40 Lighthouse tube 2.50

ARC-5 ACCESSORIES

Mounts \$1.00
 Double Mounting Rack 1.65
 Shock Mounts .95
 All parts interchangeable with SCR-274-N

DIRECTION FINDER

Designed for Marine Use—(Navy DP 12). Covers broadcast and marine frequency bands, 100-1500 KC. Complete installation with accessories and spares. Operation: 115V AC or battery pack. Loop can be operated remotely \$195.00

HEADSETS

New Insert Type—comfortable, lightweight, efficient: 500 ohms impedance \$.85
 Output Transf. to match 500 ohms to 8000 ohms .35
 Headgear—Dynamic mike and headset combination. sound powered, moving coil type. Mike and ear phones complete. From B19 Transmitters. 1.85

RCA 12 Tube Superhet

100 to 1500KC. 115V AC operation Dim: 24"x18"x13". Used: in excellent condition guaranteed \$29.95

NAVY RCA—RAK-7 Receivers, 500kc band, 115 VAC operation, complete with spares \$69.50

All merchandise guaranteed. Mail orders promptly filled. Prices F.O.B. N.Y.C.

Send Money Order or Check. Shipping charges only sent C.O.D. Send for Flyers. Rated concerns send P.O.

COMMUNICATIONS EQUIPMENT CO.

131-N LIBERTY ST., NEW YORK 7, N. Y.

Telephone WH 4-7658

Don't Muff Your Chances in RADIO ELECTRONICS



**NEW DEVELOPMENTS
SPELL
New Opportunities!**

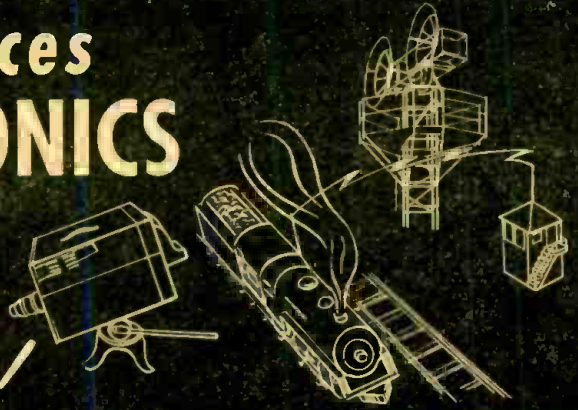

YOU MUST ADD TECHNICAL TRAINING TO YOUR PRACTICAL EXPERIENCE!

Old jobs as well as new ones in radio require new knowledge. To forge ahead you must "Know the WHY as well as the HOW." FM, Television, Micro-Wave Relay Systems, Mobile Communication System for trains, buses, automobiles, trucks,—all these new tech-

niques and many more mean new, better jobs for you who are qualified. Start your training NOW for one of those better, more exciting jobs in this New World of Electronics!

LET CLEVELAND INSTITUTE TAKE OVER YOUR PERSONAL UP-GRADING PROBLEM!

Qualified, competent instructors, ample, personalized instructional aids, orderly, progressively arranged study assignments in recognized, approved technical texts—these are only a few of the many superior advantages of CIRE'S plan of personalized spare-time home study training for professional self-improvement.

CLEVELAND INSTITUTE COURSES OFFER COMPLETE TECHNICAL TRAINING RANGING FROM LOW-LEVEL TO COLLEGE-LEVEL.

- A. Master Course in Radio Communication. Covers complete preparation for broadcast station employment including preparation for FCC License Examinations.
- B. Advanced Course in Radio Communication Engineering. A college-level Radio Engineering Course.
- C. Specialized Television Engineering. Including post-war Television Techniques.

All Courses Include

The Remarkable Workbooks of Instructional Aids, prepared by the instructing staff of Cleveland Institute.

Choose the course best suited to your needs—Start with the section you are qualified to enter—Use the economical CIRE "Pay-As-You-Go-Plan."

ENROLL FOR INDIVIDUAL SECTIONS OF COURSES, IF YOU PREFER

If you need only highly specialized training, you can study one or more of the following sections instead of a complete course.

1. Mathematics of Radio.
2. Fundamentals of DC and AC Theory.
3. Essentials of Radio Communication.
4. Communication Networks.
5. Advanced Radio Telephony for the Broadcast Operator.
6. Audio and Radio Components and Systems (Design of Receiver and Transmitter Equipment).

CLEVELAND INSTITUTE OF RADIO ELECTRONICS

Contractors to the Canadian Broadcasting Corporation

RC-8 Terminal Tower
CLEVELAND 13, OHIO

Approved for Training under "G-I Bill of Rights"

(MAIL THIS COUPON)

Cleveland Institute of Radio Electronics, RC-8, Terminal Tower, Cleveland 13, Ohio.

Gentlemen: Please send information about your home courses in Radio Electronics:

NAME

ADDRESS

CITY

ZONE STATE

I desire training in A B C
I have had experience in broadcasting servicing
operating mfg. CAA Army-Navy
amateur other I am a
High School Grad. College Degree
 Check here for Veteran Enrollment Information.

How To Pass
FCC
LICENSE
EXAMINATIONS

CLEVELAND INSTITUTE
OF
RADIO ELECTRONICS
Terminal Tower - Cleveland, Ohio

Don't Delay—
Write Today!

Approved for Veteran
Training under
"GI Bill of Rights"

CLEVELAND INSTITUTE OF RADIO ELECTRONICS

Contractors to the Canadian Broadcasting Corporation

RC-8 Terminal Tower
CLEVELAND 13, OHIO

Get your FCC Commercial Radio Operators' LICENSE NOW!

IT'S EASY IF YOU FOLLOW OUR PLAN!

Thousands of new jobs are opening up—FM, TELEVISION, MOBILE COMMUNICATIONS SYSTEMS, are only a few of the radio fields which require licensed operators.

TIME IS IMPORTANT TO YOU!

You can get your License quickly with NILSON'S MASTER COURSE in RADIO COMMUNICATION and exclusive CIRE Workbooks of Instructional Aids. Saves you many hours of random, undirected study.

Assures a MINIMUM of time in getting your ticket.

FREE BOOKLET tells you the Government Requirements for all classes of commercial licenses—Sent immediately upon receipt of coupon.

MAIL THIS COUPON

CLEVELAND INSTITUTE OF RADIO ELECTRONICS

RC-8 Terminal Tower, Cleveland 13, Ohio

Gentlemen: Please send information about your Home Study Course for preparation for FCC Commercial License Examinations. (Does not cover Amateur License Examinations.)

Name

Address

City Zone State

If a Veteran check here

HERSHEL'S SPECIAL SUMMER VALUES!

MINE DETECTOR

SCR 625 **\$49⁹⁵**
used.....
Brand new.....69.00

- Ass't mica condensers, Cat. No. C-12—per 100.....\$ 1.95
- Wafer Sockets, 4-5-6-7 and 8 prong. Cat. No. WF-4—Per 100.....\$ 2.95
- 12" Utah P. M. Speaker, Alnico No. 5 with 6F6 output transformer. Cat. No. ST-100 \$ 6.95
- Ass't knobs push on wood and plastic. Cat. No. KP-100—per 100.....\$ 1.95
- Johnson sockets No. 210-25W. Cat. No. JS-210..... 49c
- Sockets for acorn tubes. Cat. No. AT-10... 19c
- Jacks Pl 55, Pl 68.....15c
- Powdered iron slug with Isolantite coil form to match, ideal for broad tuning. E. C. O. 25c
- Powdered 1/4 slug.....10c
- 1 Meg. Shallcross Acra—Ohm wire wound resistors ±1W.....89c

FILAMENT TRANSFORMER

- 110-V, 60 cy. Pri. sec.—5V—3A. Shelled Case.....**\$1.49**
- 110-V, 60 cy. Sec.: 2.5V at 5.25 amps. Shelled Case.....**\$2.45**
- 110-V, 60 cy. Sec.: 1.5V at 10 amps.; Sec.: 2.5V at 10 amps.; Connected in series will give 10V at 10 amps. Shelled Case.....**\$3.95**

BC 654

TRANSMITTER & RECEIVER

Frequencies range 3800-5800 KC.—calibration every 10 KC. —with crystal oscillator checked every 200 KC. Power output 17 watts, voice or CW. with tubes and 200 KC. Xtal.

\$14⁹⁵



BUTTERFLY CONDENSERS

Oscillator butterfly assembly condenser 76 to 300 megacycles with acorn tube socket. Mounted on condenser. Catalog No. BC 3.

\$1.95

Type B — frequency range 300 to 1000 megacycles to be used with 368 AS doorknob tube. Cat. No. BC2.

95^c

POWER TRANSFORMER

Pri. 115-V, 60 cy.; Sec. 1, 255/255 80ma.; Sec. 2, 63V 3.8A.; Sec. 3, 5V 4A.; Cat. No. H.P. 15.....

\$1.29

scope

SUPPLY TRANSFORMER

Pri. 110-V AC 60 cy.; Sec. 4000-V VAC 10MA; Weight 8 3/4 lbs.

\$3.95

NEW BC 223 AX TRANSMITTER

801 Oscillator and 801 Power Amplifiers, 2-46 Modulators and 1-46 Speech Amplifier 4 Kial Frequencies and Master Oscillator on selector switch. 10 to 30 watts output. Tone Voice or C.W. Mod. Ideal for 80 meter band. Comes with 3 coils TU 17A 2000-3000 Kc. TU 18 3000-4500 Kc. TU 25 3500-5250 Kc. Black wrinkle case. Includes 2 separate cases to store extra coils. Frequencies chart and tubes included, packed in original cases, less crystals at this low price.

\$29⁹⁵

Shipping weight 125 lbs.

BRAND NEW SCR-269-F AUTOMATIC DIRECTION FINDER RADIO COMPASS

COMPLETE WITH COMPONENT PARTS **\$75⁰⁰**

The radio compass SCR-269-F was designed to be the primary radio navigation compass for the United States Army and Navy Air Forces. Constant reception is possible day or night so that fixes can always be made to establish the plane's or ship's location.

Plotting fixes is accomplished by selecting two or more stations and plotting these on the navigation map. The point of intersection of these lines indicates the location of the craft.

This equipment comes complete with 17 tubes superheterodyne receiver which is tunable from 200-1750 KC in three bands less inverter. A complete instruction book for operation and maintenance accompanies this equipment.

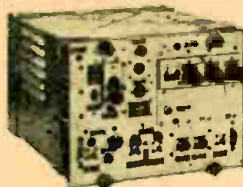

Transmitter & Receiver

The famous boat anchor, widely used on the 144 MC band. Complete power supply 110V—AC. Less power transformer and tubes. Shipping weight 100 lbs.

\$14⁹⁵

MODULATION TRANSFORMER 1KW

Shipping weight 52 lbs.

\$14⁹⁵

RCA modulation transformer is conservatively rated at 550 Watt audio to modulate that new KW rig. Really rugged construction with protective flashover gaps, which are adjustable. Terminals and gaps are mounted on a "Mycelax" terminal board. The laminations that make up this transformer are of high audio quality and are extremely thin, making it impossible for the core to "chatter or talk".

Audio Watts—550 Sec. #1-450 Mills Sec. #2-80 Mills Turns Ratio—Pri Sec. #1-1:1 Pri. Sec. #2-5:1 Pri. Sec. #2 Tap-25:1. Impedance Ratio—Pri. #1-1:1 Sec. Pri. Sec. #2-25:1 Pri. Sec. #2 Tap-625:1. DC Resistance—Pri: 135 ohms Sec: #1: 112 ohms; Sec: #2: 99 ohms.

Transformers insulation tested: Pri. 8000V.; Sec. #2-2000V. to the rest of the coils and core. Primary center tapped for Class "B" modulators. Secondary #2 will carry 80 Mills to modulate screens of beam power or screen grid tubes. Primary will match any Class "B" tubes up to 10,000 ohms plate to plate, such as 810's, 75T's, 8005's, 2B120's, 203's, MY51Z's, 211's, 813's, 828's, 805's, 2037's. Size 9 1/4" wide, 7 1/2" deep, 7 1/4" high. Heavy channel iron mounting brackets. Weight approx. 40 lbs.



GENERAL ELECTRIC METERS

Type D041, 0-10MA, on 0-500 MA. 3 1/2" Round case.

\$3⁹⁵ each.

THORDARSON T48003

2H-7H 550 MA swing choke. Size 4 1/2 x 5 1/2 x 5 1/2. Square black crackle case. Cat. No. FC-205.

\$5⁹⁵

TUBES • TUBES • TUBES

813.....\$5.45	955......65	58P1.....3.95
RK60..... 1.25	9004......65	5CP1.....3.45
VT127..... 2.95	6J4.....1.50	5FP7.....3.45
VR150......69	6J6......95	7BP7.....4.45
829..... 2.45	3AP1.....2.45	9LP7.....5.45
872..... 1.95	3BP1.....2.45	304TH.....6.95

1T4 - 1S5 - 3S4 - 1R5 **59^c**
3Q4-6SN7-6SL7-6SA7 **59^c each**

VARIABLE CONDENSERS

5 gang, app. 50MMFD per section. Air padders with worm drive 18 to 1 ratio. Flexible coupling. Condenser 6" long—1 1/4" wide—2 1/2" high. Ideal for FM and Television and R.F. section.....

\$1.95

VARIACK—1 amp—\$3.95 5 amp—\$7.95

ASS'T H. F. CHOKES.....50c doz.

- WRITE FOR FREE BULLETIN
- MICH. SALES ADD 3% SALES TAX
- MINIMUM ORDER \$2.00 FOB DETROIT



PHOTO FLASH TUBE

High speed photo flash tube, 12,000,000 lumens light output. Stops all action. Ignition coil included on back of bulb. 10,000 flashes. Diagrams furnished on request. Your cost only.....

\$8⁹⁵



MICA CAPACITOR .002 MFD 3000 VDC. Cat. No. RT-101.....

49c

30 MC IF Transformer in square aluminum can, silver slug tuned

29c

CORONA BALLS

Grid and plate connections for VT 127—250 TH etc. Round ball type heat dissipating silver plated.

10^c each \$1⁰⁰ doz.

HERSHEL RADIO CO.

5249 GRAND RIVER

DETROIT 8, MICHIGAN

20% DEPOSIT REQUIRED ON ALL C.O.D. ORDERS

CAPITOL RADIO ENGINEERING INSTITUTE

—Where Professional Radiomen Study



GET YOUR FOOT IN THE DOOR

With the Help of CREI Modern Technical Training

Prepare for Money-Making Opportunities in the Expanding Field of RADIO-ELECTRONICS SERVICING

CREI Home Study Courses in Practical Radio-Electronics and Television Will Equip You to Do a Better Job—Enjoy a More Secure Future—Start a Business of Your Own.

Foresighted radio servicemen are looking ahead to the future. A future that has unlimited opportunities and real profits for those who have the "KNOW-HOW" to service the new types of broadcast and television receivers—and the multitude of new and complicated communication and electronic equipment being installed in cities and industries everywhere.

Your own field, that just a few years ago was confined to the servicing and maintenance of simple AM receivers, has expanded so fast, and in so many directions, that it is doubtful if many sincere servicemen can say they are fully qualified to meet present-day demands. You are facing a new era with opportunities

not "knocking at", but "throwing open" doors to new opportunities.

Now is the time to take the time to equip yourself with CREI up-to-date, radio-electronics training to keep pace with new developments and new techniques. This is the same practical training for which thousands of professional radiomen have enrolled since 1927. CREI home study courses will keep you abreast of modern developments, improve your technical knowledge and prepare you to service the most advanced equipment. Our proved method of spare time instruction combines practical, easy-to-understand theory with your own practical experience.

It's up to you to decide whether you will be a "screwdriver" mechanic or a trained service technician. It costs you nothing but a moment's time to find out by sending for complete, free details.

VETERANS! CREI TRAINING AVAILABLE UNDER THE "G.I." BILL!

MAIL COUPON FOR FREE BOOKLET

If you have had professional or amateur radio experience and want to make more money, let us prove to you we have the training you need to qualify for a radio job. To help us intelligently answer your inquiry—PLEASE STATE BRIEFLY YOUR BACKGROUND OF EXPERIENCE, EDUCATION AND PRESENT POSITION.



Capitol Radio Engineering Institute

An Accredited Technical Institute

DEPT. RC-8 16TH AND PARK ROAD, N. W., WASHINGTON 10, D. C.

Branch Offices: New York (7): 170 Broadway • San Francisco (2): 760 Market St.

RADIO-CRAFT for AUGUST, 1947

CAPITOL RADIO ENGINEERING INSTITUTE
16th & Park Rd., N. W., Dept. RC-8, Washington 10, D. C.
Gentlemen: Please send me your free booklet, "CREI Training for Your Better Job in RADIO-ELECTRONICS", together with full details of your home study training. I am attaching a brief resume of my experience, education and present position.

Check PRACTICAL RADIO ENGINEERING
Course PRACTICAL TELEVISION ENGINEERING

NAME _____

STREET _____

CITY _____ ZONE _____ STATE _____

I am entitled to training under the G.I. Bill.

Start Your Own RADIO SERVICE SHOP

\$99⁵⁰

Choose one of these
3 GREAT NEW DEALS

\$179⁵⁰

Includes TEST EQUIPMENT, TUBES, PARTS, TOOLS

3 complete going-in-business packages. (If necessary they can be changed to suit your needs.)

There never was a better opportunity than now to start a profitable business of your own. No fuss, no worry. Here's everything you need. Details upon request. Write, wire or phone!

\$350⁰⁰

Featherweight Miniature TEST INSTRUMENTS

Compact — Accurate — Priced Right!

- Jeweled Meter • Range Selector Switch
- All multipliers bridge tested for 1% accuracy
- Zero adjustment—built in batteries
- Molded bakelite case only 3-13/16" x 2-7/8" x 2"

MODEL 451A AC-DC Volt—Ohm—Milliammeter



A dependable instrument of wide utility—sensitivity 1000 ohms per volt. Ranges: Volts AC, DC, and Output Ranges, 0-10/50/100/500/1000; Ohms full scale, 500,000. Ohms center scale, 7200.

NET complete with batteries..... **149⁰⁰**



MODEL 312 Volt—Ohm—Milliammeter

An economy pocket meter featuring a 2" moving vane meter. Reads: AC-DC volts, 0-25/50/125/250; Mills AC-DC, 0-50; Ohms, 100,000; mfd., .05-15. Jacks provide range selection.

NET Complete with cord and plug..... **67⁵⁰**

FAMOUS "LITTLE TRIPLETT'S"

The little Testers with the big 3" Meters Bakelite cases 3 1/8" x 5 7/8" x 2 1/8" Range selection switch—long, easy to read scales. We made a good buy—here they are at rock-bottom prices—The greatest buy ever offered in precision testing equipment.

Model 650SC - OUTPUT METER

A 4000 ohm constant impedance AC volt meter with ranges of 0-1.5-6-15-60-150 volts. Conversion chart for reading DB level from—10DB to +35 DB. 100 microampere meter. Excellent for receiver alignment, level indicators in recording equipment, general use on electronic apparatus. Regular net 24.50. A "one time only" Special buy at..... **1049**



Model 606B-VOLTAGE TESTER



Checks voltage and polarity. Range: 0-440 AC-DC volts—definite indications for 115, 220, and 440 volt lines. Separate polarized vane for AC or DC indication. Built in test leads. Excellent for checking wiring, fuses, general factory installation and maintenance. Every plant — every electrician needs several at this low price. Regular net 16.67 Special at..... **89⁵⁰**

RADIART AERIALS

The Quality leader • Recognized by everyone • Admiralty brass rods • Triple plated • Permanently rattle proof • Static muffler ball • Polyethylene insulated HI Q lead with protective vinylite covering • Supplied with single pin (Matarola) connector and adaptor for bayonet style (Delco and Philco) fittings.



TYPE CF3-63

A two insulator side cowl mount—3 section 63" rod—supplied with 3 insulators and wedge adaptor to fit 95% of all car bodies—complete with 48" lead. List price \$4.95—our price..... **199**



TYPE CFA3-63

All angle cowl or fender mount—A modern Radiart development—fits all body contours, straight or curved, cowl or fender. 3 section 63" rod easily adjusted to vertical with-out tools—complete with 40" lead. List price \$5.45 we sell for..... **199**

GENERATOR CONDENSERS



PHILCO part No. 61-0177—5 mfd.—3/4" x 1 1/8"—4" lead-slotted mounting strap for easy installation—Standard Merchandise—not war surplus—Present list price \$1.00. Our special—over 83% off..... **14c**

200 WATT SOLDERING IRON FAMOUS HEXACON ELECTRIC'S MODEL 201



FEATURES: Full 200 watt replaceable element. 3/8" tinned Copper tip, replaceable. One piece drawn case-gun metal finish. 6' heavy duty cord—stand included. Comfortable, well balanced handle. Operates on 110 volts—AC or DC. List Price \$8.00. Speed up your heavy work—Save time—save money at..... **369**

OUTPUT TRANSFORMERS

Clean stocks — long leads — mounting feet — made to fit where you need them. For 6F6-6K6—to 4 ohm voice coil—size 2" x 1 1/8" x 1 3/8". 50L6-35L6-25L6 to 4 ohm voice coil 1 3/4" x 1 1/2" x 1 3/8". Specify quantity of each type you need at..... **49c**



Order from the Ad Write - Wire - Phone

PHONO PICKUP CRYSTALS

Standard types—Set Manufacturers close-out—all Guaranteed



Webster F2—Replaces L26-L40-L70 etc.—pin type terminals—1 oz. pressure—1 volt output—5000 cycle cutoff. List price \$5.00—your price..... **149**



SHURE P93—W57A—pin type terminals—1/2 oz. pressure—1.6 volt output—6000 cycle cut off. List price \$4.45—our Special..... **198**



Astatic L-70—new postwar design—solder terminals—1 1/4 oz. pressure—1 volt output—4000 cycle cutoff. List price \$5.55—we quote you... **198**

PHILCO BEAM OF LIGHT

Selenium cell only, no holder, postpaid... (Puts new life into Philco Changers) Sapphire needle only, no mirror, postpaid..... **180**
120

ALL RUBBER LAMP CORD



Underwriters Approved brown rubber covered insulated parallel Cord—"zips" apart easily—non fraying—deluxe—way above average quality. 500' Roll..... **989**

MULTI-USE WIRE



Stranded No. 22 tinned wire—glass "ROCKBESTOS" 1000 volt insulation—fireproof aircraft wire—a wartime development—at this low price you can use the best—

100 feet..... **45c** 1000 feet..... **389**

JEWELLED PILOT LIGHT ASSEMBLIES



- Candelabra screw base for 110 volt lamp.
- Mount in 1" hole.
- Lamps removable from front of panel.
- Available marked 1-2-3 or 4 on back of white lens.

YOUR CHOICE net..... **19c**

Include full remittance with orders of \$3.00 or less. Include 25% deposit with all C.O.D. orders of \$3.00 or more. Prices subject to change without notice.

SEND FOR FREE CATALOG

RADIO SUPPLY & ENGINEERING CO., Inc.

125 SELDEN AVE. DETROIT 1, MICH.

FM BOOM

FM Is Now in a Major Ascendency

By HUGO GERNSBACK

FREQUENCY modulation made notable progress before World War II. It has now—in the postwar period—reached boom proportions. This is true of both FM transmitters erected and contemplated, as well as in FM receiver production.

The latest figures made public by the FCC give the following picture as far as FM transmitting stations are concerned:

FM stations operating as of June 1, 1947, total 223. As of June 1 there have been granted 568 construction permits for transmitters, which reasonably may be expected to be in operation before very long. This gives a grand total of 791.

Against this we have 1,239 licensed AM transmitters as of June 1, and 522 AM stations under construction, or a total of 1,761.

To keep abreast of all the new FM stations, which are now mushrooming all over the countryside, the radio set industry has striven valiantly to keep up with the FM receiver demand, yet so far it has not been too successful. The demand continues to outrun production.

Last June the Radio Manufacturers' Association predicted that total radio production may be more than 15% under the expected 1947 output.

The RMA looked for a 1947 output about equal to that of last year's 15 million sets. Yet, during the past few months the industry was producing at the rate of 18 million sets a year. The trouble, however, is that the radio makers find that they cannot sell all the sets they make, particularly in the AM classification.

FM receivers are selling at an accelerated rate over AM sets, and it is quite likely that there will be no decline in FM output which reached a high of 112,000 sets in April, according to the RMA.

A spokesman for the RMA also stated "Manufacturers who formerly scoffed at FM are now eager to enter the field with its new market potentialities. However, FM sets are not easy to make and some manufacturers will not reach planned production goals."

So far the radio industry itself has not told, by publicity or otherwise, the bewildered public just what the AM *vis-à-vis* FM radio situation means.

The average set buyer nowadays knows of the existence of FM mainly because the radio *dealers* educate the public to it. But the average buyer is puzzled as to the future of radio reception as a whole.

They want to know the answer to the question "Is AM radio here to stay or is it being supplanted by FM?" Then there is also the extra puzzle of television, thrown in for good measure, which further bewilders the public.

It is easy to understand why AM sets are not selling as well as FM sets nowadays because anyone listening to the much better reproduction of FM sets would almost automatically choose an FM over an AM receiver. The nearly staticless reproduction—without background noise—naturally impresses the public.

How soon will AM become obsolete in this country? That is a difficult question to answer, one guess being as good as another. It would be futile to predict how many years it will take to accomplish this, but one thing seems certain: AM will fade slowly and gradually out of the picture. There seems little doubt that today we are in a transition period. The tremendous upswing in FM transmitters certainly points the way to the future of radio broadcasting in this country.

There are those who will maintain that we will always have AM. It is entirely possible that there will be a number of such transmitters still operating for very many years to come in this country, but certainly the trend is unmistakably toward FM.

In the meanwhile manufacturers of radio receivers are trying to straddle the fence by serving the two fields, i. e., in building combination AM-FM receivers so that both types of reception can be had in one receiver.

Unfortunately the consensus of opinion is that so far such combination receivers—at least the smaller table models—have not worked out too well. There are many technical difficulties to be overcome, and while in due time such combination receivers will be produced successfully; with few exceptions at the present time the results have not been too good.

Despite the fact that FM receivers are more expensive than AM receivers, the public—always eager to get the latest and the best—prefers the more expensive FM sets. FM receivers eventually will sell for less than they do nowadays, but not until radio manufacturers become more expert in the intricacies of their manufacture.

In the not too distant future, FM sets probably will sell at a lower price than present-day AM sets. That stage has not yet been reached.

A somewhat similar situation prevails in automobile FM receivers, which so far are not in large production, and portable FM sets, which are still in the experimental stage. Many technical problems have to be solved to make such types possible, but they will be solved.

With automobile receivers there are, of course, some disadvantages to FM. With FM range limited to about 25 miles from the transmitter, anyone taking a long automobile trip will have to switch from station to station as he progresses along the road. Thus, during a hundred-mile trip, switching or tuning to 4 different stations will be necessary. This may or may not be a great disadvantage. It might even be pointed out that many AM transmitters become weaker at the 25-mile range too, except for the much more powerful transmitters.

As for portables and pocket FM radios, both these seem to be in the future. So far only experimental models have been evolved and much engineering work remains to be done in that class.

The country now has one of its cyclic radio booms—this time in FM—which conceivably may last until the end of 1948 and perhaps longer.

ELECTRON LIGHT was seen for the first time last month in the laboratories of General Electric. The light came from electrons whirling in the new 70,000,000-volt synchrotron, and comes literally from the moving electrons.

In 1944 two Russian physicists, D. Iwanenko and I. Pomeranchuk, pointed out that radiation should come from the electrons moving in circular orbits in a betatron, a form of atom-smasher related to the synchrotron. This effect, they said, would impose a limit on the simple betatron. Over about 100,000,000 volts, the electrons would radiate energy away as fast as they receive it unless proper compensation were made.

Calculations indicated that such an effect should be observed from the electrons in the 100,000,000-volt betatron in the GE Research Laboratory and that some of the radiation should be visible light. However, the "doughnut" of the betatron is lined with silver, which makes it opaque, thus preventing any observation. Then it was thought that perhaps some radiation of the very short radio waves might be detected, using methods developed for war-time radar. But again the search was unsuccessful. Dr. J. S. Schwinger of Harvard University calculated that while there might be some slight emission in the microwave region, the maximum amount of energy would come in the shortest wave lengths, either visible light or the longer invisible waves of infra-red.

The new synchrotron doughnut is lined with a transparent layer which is electrically conducting like the silver layer and carries away unwanted electrical charges as they accumulate. Recently a GE laboratory assistant, Floyd Haber, noticed a curious spot of light inside the doughnut while the synchrotron was operating. After checking to assure that everything was working properly, the physicists in charge of the project determined that this was actually radiation from the electrons themselves as they moved in their circular path.

Electron light travels out in a beam half a degree in diameter, tangent to the orbit. It comes out ahead of the electrons. Thus, an observer looking at the doughnut from a point in the plane of the orbit sees light from the electrons approaching him, but cannot see the light in any other part of the tube.



Section of the "doughnut," showing the light. Since light is thrown off tangentially by the speeding electrons, it can be seen only from a point where the observer views a section of the doughnut "end on."

RADIO-ELECTRONICS

Items Interesting to

Because of the curvature of the doughnut, the spot is distorted at present. Dr. Herbert C. Pollock, who has charge of the synchrotron project, and his associates, Drs. R. V. Langmuir and Frank R. Elder, are preparing a modified doughnut with a flat quartz window through which the effect may be better seen. This will permit any part of the radiation that may fall in the invisible ultra-violet part of the spectrum to be photographed, since quartz, unlike glass, is transparent to these rays.

FM TELEPHONE LINK between Death Valley, Cal., and the rest of the world is the first 150-mc FM point-to-point radio in the Bell Telephone system, a last month's release from that company states.

Increasing number of tourists and business arising from exploitation of the Valley's mineral resources necessitated the link, which replaces an older single pole line.

Radio transmitting and receiving equipment similar to that used in the land station of an urban mobile telephone system was installed in the existing Specter Mountain repeater station on the Las Vegas-Reno line, and in a Quonset hut just outside the town of Death Valley. This at present provides two telephone links between the two points, nearly 30 miles apart.

Telephone messages from the outside world reach Death Valley through San Bernardino. They travel by open wire to Specter Mountain via Las Vegas, thence by radio to the Death Valley radio station, and from there by wire two miles to the town of Death Valley itself and 28 miles to the resort areas, including Furnace Creek Inn. Telephones in the Valley region can ring each other and operator assistance is given at San Bernardino, Cal.

While Death Valley and San Bernardino are 160 airline miles apart, there

are 251 highway miles and 341 circuit miles between them.

A 37-mile section of the old telephone line between Silver Lake and Tecopa, no longer required, will be abandoned.



The 150-mc FM relay station at Death Valley.

FACSIMILE newspaper service, independent of either a regular newspaper or radio station, is planned for Springfield, Mass., it was announced by the New England Facsimile Corporation.

Receivers will be placed in homes on a monthly rental basis.

Programs consist, roughly, of 24 to 32-page morning editions transmitted from 3 to 5 am; bulletin service till 3 pm; market reports, business news, comics and amusement service till 4 pm; bulletin "run of wire" service till 9:30 pm; and late evening news and sports finals 'til 10 pm.

Springfield is especially well suited for the experiment in news distribution. Its citizens have been without regular newspaper service for the greater part of 8 months because of a labor dispute between Sherman H. Bowles, owner of the city's 5 newspapers, and the local printing trade unions and the Newspaper Guild unit. During this period, they have been conditioned to new ways of receiving their news. For a considerable period they were dependent on the local broadcast stations, which expanded their news programs greatly, and even printed a daily mimeographed sheet.

MONTHLY REVIEW

the Radio Technician

A TELEVISION RELAY circuit for commercial operation between New York City and Schenectady, N. Y., was opened last month by the General Electric Company. The circuit will be extended to Syracuse later.

The new relay operates in the 2,000-

megacycle region. Extremely directional, the microwaves are beamed from a transmitter atop the General Electric office building in New York City to a relay station on Beacon Mountain, 55 miles north from New York. From there they travel 55 miles to Round Top Mountain where another relay tower transmits them 29 miles to the Helderberg Mountains. Picked up by a third relay tower there, the signals are sent 14 miles to the Schenectady terminus.

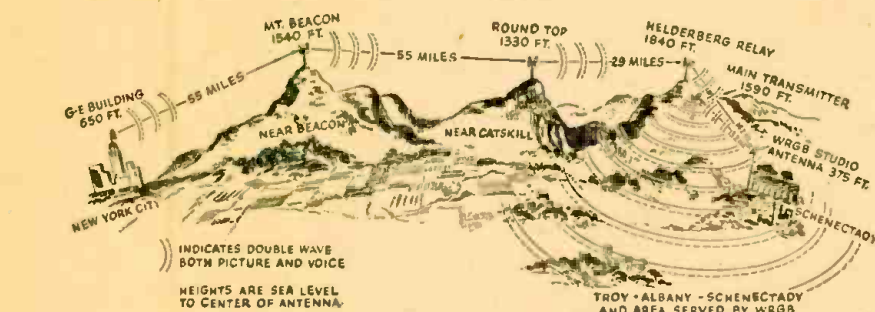

NEW YORK-SCHENECTADY TELEVISION RELAY

At present the microwave relay circuit uses separate carriers for the sound and picture components of the signal, but it is planned to convert the present system so that use of only one of the microwave channels is required for handling both aural and visual signals. This will be done by the addition of multiplexing equipment at the two terminals. Incorporated in production equipment, multiplexing equipment would greatly reduce the cost of constructing the television relay and as well would lower the operating costs.

Television station WRGB at Schenectady now has pending before the FCC an application to use this circuit commercially for relaying to the Troy-Albany-Schenectady area television programs available in New York City.

The General Electric Company has been relaying television programs from New York City for the past 7 years on an experimental basis.

AMERICAN-LANGUAGE broadcasts were commenced last month by Radio KGAK, Gallup, New Mexico, in a series of Saturday afternoon news broadcasts in Navajo for the large Indian population of the area.

Gallup is the trade center of vast Indian reservations, of which the Navajo

CITIZENS RADIO appears to be closer as Raytheon announces a new tube which puts out appreciable power at the high frequencies above 450 mc. The subminiature type CK608CX is a high mutual-conductance triode with a 200-milliamper, 6.3-volt heater. It is only four-tenths of an inch in diameter and 1½ inches long, but will put out about 1 watt of power at approximately 25% efficiency in the Citizens radio band of 460 to 470 megacycles. Reduced output can be obtained up to 800 megacycles or more.

The photograph of the oscillator shows the CK608CX operating in the Citizens band and lighting a 150-milliamper, 6.3-volt pilot lamp to full brilliance. The CK608CX is used with a sub-miniature socket similar to those now commercially available. The tube may be soldered into the socket with some increase in operating efficiency at these frequencies.

Still needed is a tube that will operate from a 1.5-volt A-battery, for use in the light pack transceivers which will be required for mobile use.

New Subminiature High Frequency Power Tube.

TELEVISION NEEDS drastic price cuts on receivers and considerably better quality of programs if it is to be an early success, according to a survey released last month by *The Televiser*.

The survey was made among 800 television dealers who visited the receiver displays at the recent Television Institute held at New York's Hotel Commodore.

According to the study, the public is prepared to part with \$500 for a television receiver, provided the instrument includes AM, FM, and a phonograph. The present price range for such receivers, the study indicated, is from \$800 to \$2,500.

Over 50% of the dealers thought table models, the kind most frequently sold today, should be ticketed from \$200 to \$300, instead of \$250 to \$400—the present price range on standard makes.

Among the hurdles in selling television receivers today, states the *Televiser* survey, are:

1. Refusal of apartment house owners to permit installation of antennas: 15.7%.
2. Price of antenna and receiver installation: 13.4%.
3. Poor quality of programs and not enough programs: 13.4%.
4. Lack of daytime programs: 11.9%.
5. Lack of merchandise for early delivery: 11.2%.
6. High price of receivers: 9.7%.
7. Small size of screens: 6.0%.
8. Miscellaneous: 8.7% including uncertainty of set delivery, possible future price cuts, lack of set selection, fear of early obsolescence, desire for color, problems of clarity of reception, demand for short term credit.

MAPS MADE BY RADAR were announced last month by Charles J. Pannill, president of the Radiomarine Corporation of America. The maps are of the type used in river navigation, and were assembled as a mosaic of numbers
(Continued on page 57)

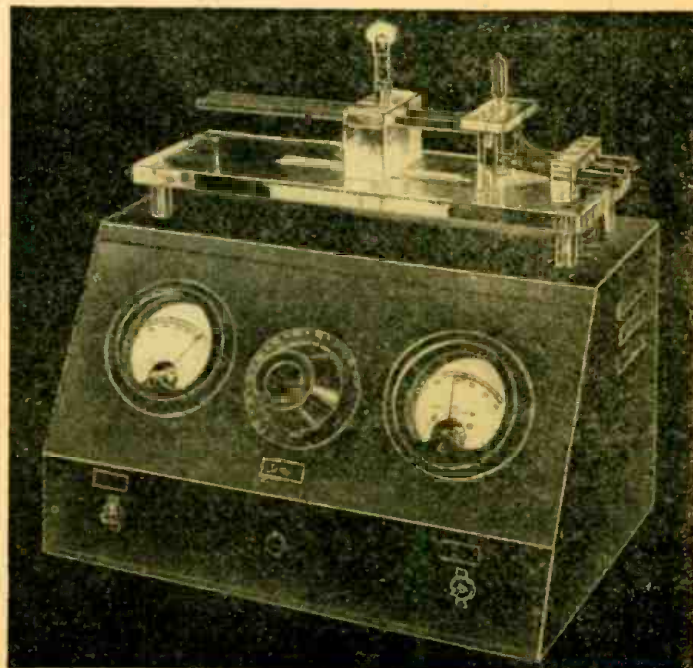

Portable Recorder-Player

Recorder, record player, PA system and a radio in one instrument

By JOSEPH G. KARNATH, W2RRA



ALTHOUGH this recorder adds nothing radically new to the field of recording equipment, it does have several unique features which, to the writer's knowledge, have never been combined into a 1-piece portable unit. The model illustrated in the accompanying photos was developed and built by the writer during the long winter evenings while ham radio was taboo, and the interest shown by several capable radiomen spurred the builder to write this article.

Several units have already been constructed by fellow radio tradesmen and several more are in process. Cost of components is surprisingly low, compared to the net price of a manufactured unit of comparable quality, and its additional features make for a unit of utmost versatility.

It may be used as a recorder, record player, radio, or a public address system. In its recording capacity, records

can be cut at either 33 1/3 r.p.m. (transcription speed) or at 78 r.p.m. (speed of ordinary phonograph recordings). All recordings may be monitored constantly by a volume-level indicator on the control panel, eliminating the danger of overcutting or undercutting and assuring uniform volume on the finished disc regardless of the type of program recorded. When recording from the microphone, the over-all gain is more than ample to pick up and record, with suitable intensity, a normal conversation anywhere in the average-size room.

A tilt-head microphone with 360-degree pickup (such as the one shown) will allow the recordist to make many candid and interesting recordings at parties and gatherings. Any radio program may be recorded merely for the tuning in. When recording from the radio, monitoring is done not only visually by the use of the volume indicator meter, but also audibly, at a reduced volume level, through the speak-

er. The unit also can be used to re-record any previously cut recording, or to make copies of any phonograph record, simply by plugging an auxiliary turntable pickup into the RE-RECORD jack on the front panel. This feature has proved its worth in many instances when a certain choice record was sold out but could be borrowed for a few minutes from a friend. There are many occasions too, when a recording has been made at a gathering, that several of those present may wish a copy record. The original may be cut at the 33 1/3 speed and the copies of the desired parts may be reproduced at 78 r.p.m. so that they can be played on any record player or combination phonograph radio.

The re-record feature has been used also to produce some very unique (but perhaps rather impractical) effects. With the proper manipulation of two recording blanks and the auxiliary turntable, the author has recorded a 4-part harmony quartette of his own voice.

For ease of presentation and for simplicity of wiring and servicing, the schematic circuit diagram is broken down into 3 parts: the amplifier chassis, Fig. 1; the control panel, Fig. 2; and the tuner chassis, Fig. 3. The units are wired individually, then installed and interconnected within the case.

The amplifier (Fig. 1) consists of a 6SJ7 microphone amplifier stage feeding a 6SC7 dual triode, one section used as a second stage, the other as a phase inverter, in turn driving a pair of 6V6 beam-power output tubes in push-pull. Output is fed from the transformer T2 through the selector switch (Fig. 1) to the speaker voice coil, cutting head, or output indicator circuit.

The various positions of the switch are as follows:

AMPLIFIER PARTS LIST—FIG. 1

- T1—Power transformer, Stancor P-6013
- T2—Output transformer, Stancor A-3852
- T3—Volume indicator transformer, Stancor A-3856
- C1, C2—0.001- μ f mica condenser
- C3—0.1- μ f, 400-volt, tubular paper condenser
- C4—10- μ f, 450-volt
- C5—40- μ f, 450-volt
- C6—30- μ f, 450-volt
- C7—20- μ f, 25-volt
- C8, C9—0.05- μ f, 600-volt, tubular paper condenser
- C10, C11—0.01- μ f, 400-volt, tubular paper condenser
- R1, R2—2-megohm, 1/3-watt, carbon resistor
- R3—150,000-ohm, 1/3-watt, carbon resistor
- R4—50,000-ohm, 1-watt, carbon resistor
- R5—2,000-ohm, 10-watt, wire-wound resistor
- R6—500-ohm, 10-watt, wire-wound resistor
- R7—15,000-ohm, 1/3-watt, carbon resistor
- R8, R9—250,000-ohm, 1/3-watt, carbon resistor
- R10, R11—500,000-ohm, 1/3-watt, carbon resistor
- R12, R13—5-megohm, 1/3-watt, carbon resistor
- R14—100,000-ohm, 1/3-watt, carbon resistor
- R15—300-ohm, 1-watt, carbon resistor
- R16—50,000 ohm, 1/3-watt, carbon resistor

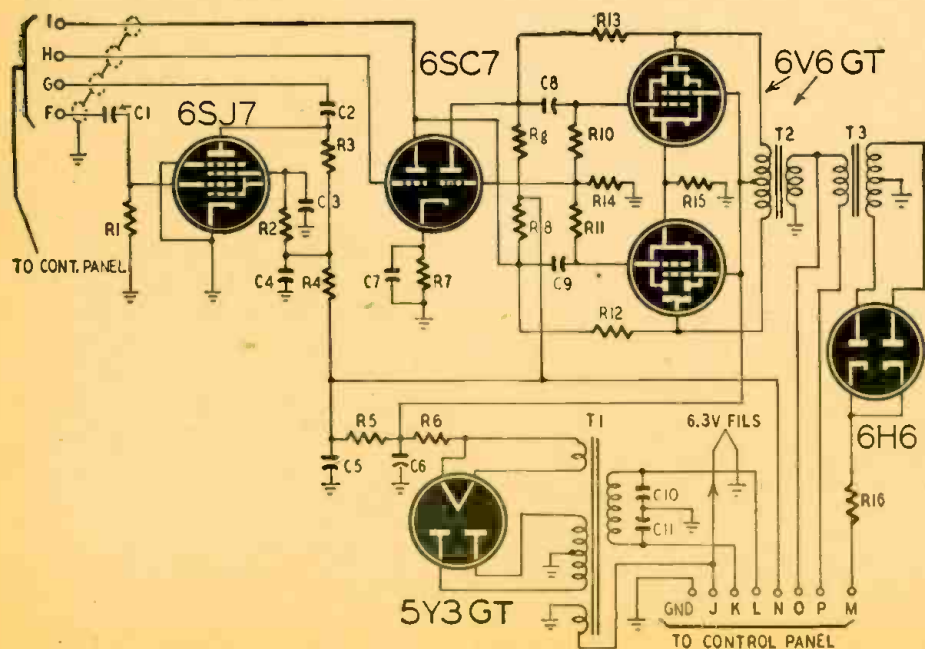

Position 1—radio reception; Position 2—radio recording; Position 3—microphone recording; Position 4—playback; Position 5—public address, blending microphone, record playback and radio simultaneously, with their respective gain controls.

The circuit and several of the constants differ somewhat from the conventional. The value of the coupling condensers C1 from the microphone, and C2 between the first and second stages is considerably lower in capacity than one might expect. This was done to rid the amplifier, particularly on low-speed (33 1/3 r.p.m.) recording, of any over-emphasized bases or boominess.

The 6SJ7 plate resistor is also lower than usual for the same reason, for as the plate resistor is decreased the high-frequency response is increased up to a certain point. Both these circuit peculiarities definitely reduce the overall gain of the stage, but this is desirable, as any tendency toward feedback and oscillation is also eliminated. More than enough gain is still available.

No direct current or cathode bias is applied to the first stage. The tube is biased by rectification of signal voltage by the grid and developed across the high value of R1, when the microphone is spoken into. This allows the cathode to operate at ground potential and prevent hum pickup through that point.

A small amount of inverse feedback is incorporated in the 6V6 push-pull output stage, for flatter frequency response

and greater over-all stability. This is done by including two 5-megohm resistors, R12 and R13, from the plates back to the grids of the 6V6 output tubes.

The output indicator circuit consists of another smaller output transformer T3 and a 6H6 dual diode, which rectifies a small portion of the output signal for the 0-1 milliamper output meter. The series resistor R16 is chosen to bring the meter to a given point (about half-scale deflection), for a suitable value of output which will give the correct depth of cut.

The power supply, with its 5Y3 rectifier, is orthodox except that no filter choke is necessary. Capacity-resistance filter C5, C6, R5, R6 is used. This re-

(Continued on page 64)

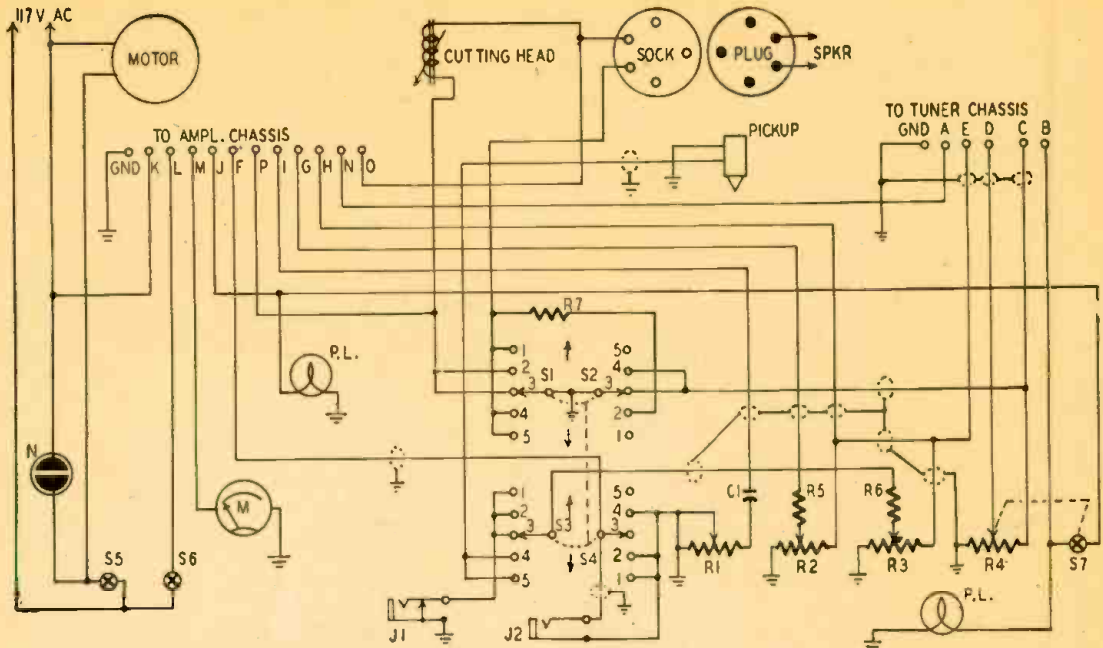

- CASE AND CONTROL PANEL PARTS LIST—Fig. 2**
- C.H.—Magnetic cutting head
 - P.U.—Crystal phono pickup
 - Motor—Turntable motor
 - SPKR—8-inch PM dynamic, Jensen PM-8-D5
 - Sw-1—Output section
 - Sw-2—Radio section
 - Sw-3—Phono section
 - Sw-4—Microphone section
 - Sw-5—Turntable motor switch, s.p.s.t. toggle
 - Sw-6—Amplifier power switch, s.p.s.t. toggle
 - Sw-7—Radio filament switch, ganged to R4
 - N—Turntable motor pilot, 1-inch jewel, 1/4-watt neon bulb
 - P.L.—Amplifier power pilot, 1/2-inch jewel, 6-8-volt bulb
- General Industries Model G.I.-R90L 2-speed recording and playback assembly
- Selection switch, 2-gang, 4-Pole, 5-position, Centralab #1415

- D.L.—Dial light, 6-8 volt, on tuner dial
- C1—0.02-uf, 600-volt, tubular paper condenser
- R1—Tone control, 1/4 megohm
- R2—Microphone gain control, 1 megohm
- R3—Phono gain control, 1 megohm
- R4—Radio gain control, 1/2 megohm with switch (Sw7)
- R5—250,000-ohm, 1/3-watt, carbon resistor
- R6—1-megohm, 1/3-watt, carbon resistor
- R7—25-ohm, 1-watt, carbon resistor
- J1—Microphone jack, single closed circuit
- J2—Re-record jack, single open circuit
- M1—Volume indicator meter, 0-1 milliamper, trip-lett 221
- S—Speaker disconnect, 5-prong tube socket
- P—Speaker plug, 5-prong plug
- Crystal microphone—Turner 33X or equivalent (with desk stand)



THE AUTHOR:

Joseph G. Karnath is an old amateur, having held a Class A license since 1930, and holds also a commercial radio telephone license.

A student of electronics and communications, he was appointed instructor in airborne radar theory and maintenance in the U. S. Army Signal Corps, after completing additional courses at Fort Monmouth.

Formally associated with Colonial Radio Corporation, Western Electric Co., and Curtiss-Wright Corporation, where he was active in the development of test methods for radio equipment and in the installation of telephone and auxiliary power equipment and where he supervised an electronic test group, Mr. Karnath at present is employed as electronics engineer by Frederic Flader, Inc., North Tonawanda, N. Y.

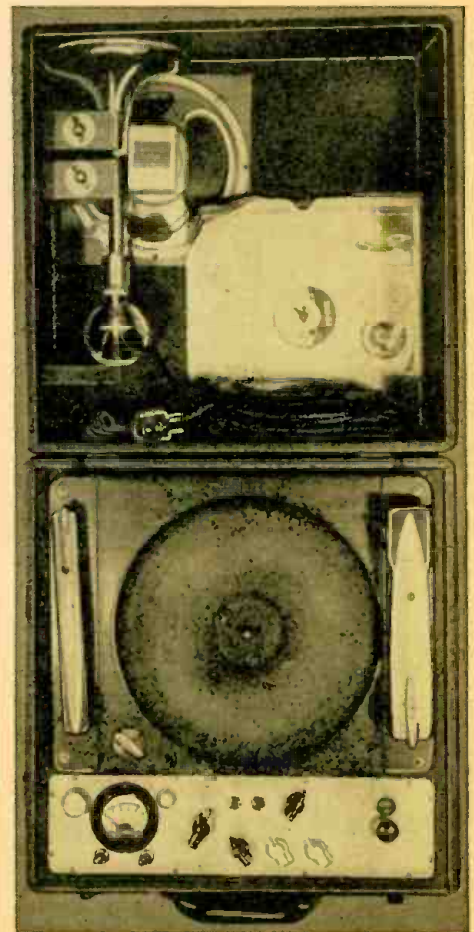

Top view of recorder and inside of the lid.



COVER FEATURE

Ham Antenna Tower For V.H.F. and U.H.F.

By BILL HOISINGTON, W2BAV

HAVING been active on the u.h.f. bands since the old days on 5 meters, and having operated on 5 or 2½ meters from almost every high spot of land in Westchester and Putnam counties (N. Y.) and on mountaintops from High Point, N. J., to Mount Cadillac in Maine, as W1LAS, it was decided to find a location where a permanent u.h.f. station could be set up for transmissions on all the u.h.f. bands with interesting possibilities of geographical coverage.

A friend, who is an amateur astronomer and understands well what amateur radio is, has been very generous in his co-operation. On his rather large estate a few miles north of Rye, N. Y., is the highest piece of land to be found in that area. Approximately 40 miles northeast of the Empire State Building, it rises to an 826-foot elevation. A 50-foot wooden observation tower, 12 feet square on top, with a 10-foot, glass-enclosed shack completes the—to us—ideal spot for u.h.f. work.

Installation of 4 kw of a.c. power from the nearest road

almost half a mile away was not easy, but is now accomplished, thanks in part to friends with extra wire.

The beam needs were easily met, as the author is the owner of a beam manufacturing company whose sole purpose is to produce beam antennas with the highest possible gain. Continued practical experiment has been combined for years with intensive study of fundamental electromagnetic theory. The theory studied has not been the so-called "classic mathematical radio theory" which has produced, among other things, the sight of thousands of amateurs for a decade (and still at it!) using close-spaced beams in the belief that they afford the highest gain. The very first time anyone *maximizes* the spacing of a beam he will find out one of the several errors of popular handbooks and the above theory. In the words of one of the great physicists, "Mathematics are of no avail if they cannot be reduced to physical reality!"

At present we have installed on the tower on one corner a 6-meter, 4-element, all Duralumin *wide-maximized-spaced* (Continued on page 76)



Left—Top of tower, with 2-meter and 6-meter beams in foreground. Below—Interior of shack, with some of last summer's equipment.

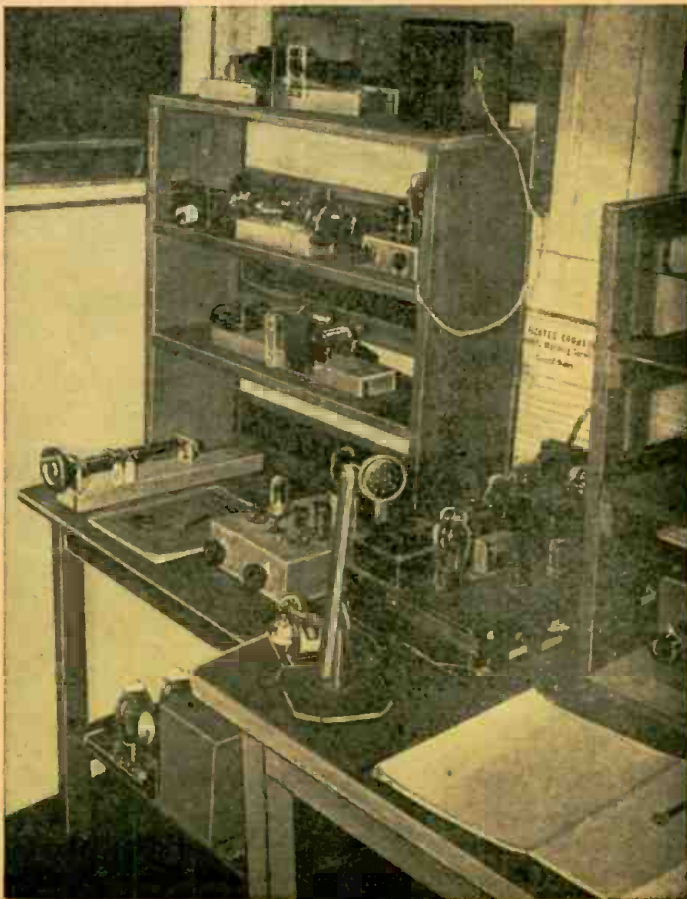

AUDIO OSCILLATOR WITH BAND SPREAD

PART I—General design considerations

By C. F. VAN L. WEILAND



THE reader is no doubt familiar with the Wien bridge or RC audio oscillator, operating principles of which can be found in any standard handbook. The basic circuit of such an oscillator is shown in Fig. 1.

Two methods of tuning this oscillator are commonly used. In one method, the resistor is varied; in the other, the capacitor. Both methods have been tried by the author. Both have inherent qualities that make it difficult for the inexperienced constructor to build a unit along conventional lines—that is, by sweeping through a large range of frequencies with one movement of the variable element. It is usual for the tuning ranges to have a 10-to-1 ratio, so the ranges can run from 10 to 100 cycles, 100 to 1,000 cycles, etc.

The author originally set out to construct such a unit, and from his early attempts learned (the hard way) a few things that made him decide to develop a unit within the reach of the average home constructor.

Design

The circuit of Fig. 1 may be considered as a 2-stage feedback amplifier with positive feedback between the output of 6J5 and the input of 6SJ7 through a frequency-selective network R1-C1, R2-C2. When R2 is equal to R1 and C2 equals C1, the circuit oscillates at a frequency determined by the formula

$$F = \frac{1,000,000}{2\pi \times R1 \times C1}$$

where F is frequency in cycles/second, R is in megohms, and C in micromicro-

farads. This shows that the frequency varies inversely as the capacity or resistance.

To keep the amplitude of oscillations as nearly constant as possible negative feedback is applied to the cathode through R3 and the lamps L1 and L2. When the strength of oscillations is low, the resistance of the lamps is low; limiting the feedback. As the strength increases, more current flows through L1-L2 and their resistance increases, which increases the amount of feedback. This action keeps the signal amplitude constant at a level where the tubes will not be overloaded.

Two oscillators were constructed along the lines of commercial models using both tuning systems. With both models conditions were encountered that make it difficult for the layman to obtain professional results. The disadvantages of condenser-tuned circuits are:

1. Extreme care in shielding and parts layout is required to prevent the oscillator from locking-in with the line frequency or its multiples.

2. The tuning condenser must have a liberal capacity ratio of 10 to 1 for a decade tuning range. This is because C1 must be shunted by a trimmer C3 to compensate for the stray capacitance between the stator of C2 and ground, which reduces the minimum capacitance. Shielding must be kept well away from the condensers to keep the minimum capacitance low. This offsets the chance of keeping a 10-to-1 tuning ratio.

Resistance tuning is generally more stable and requires less shielding, but it is almost impossible to find dual potentiometers in the order of 1 or 2 megohms that track sufficiently well for tuning purposes. Variations of 5 to 10% between the units are not uncommon.

The following facts should be

kept in mind by anyone wishing to construct an audio oscillator.

1. C1 and C2 and R1 and R2 should be well matched or distortion will be excessive. A 10% mismatch will develop about 5% distortion.

2. Coupling condensers C5 and C6 should be large (minimum 0.5 μ f) for good low-frequency response. These condensers and associated wiring should have low capacitance to ground if good high-frequency response is desired.

3. The feedback condenser C4 should be large so that its reactance at low frequencies is low when compared with the resistance of R3, L1 and L2 in series.

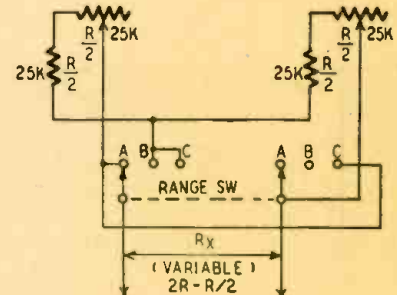

Fig. 2—Three ranges with two potentiometers.

4. If the condensers mentioned in 2 and 3 above are sufficiently large, phase shift will be kept to a minimum. If phase shift occurs, single-scale calibration for all ranges will be impossible. Deviation from the calculated frequency will increase with the frequency.

The tuning formula shows that the curve of the condenser or resistor tuning element will necessarily have a curve of 1/R or 1/C. Resistors and condensers with curves of this type are not available on the open market. When standard units are used, the scale crowds at the high end of the dial and it is almost impossible to read the dial accurately in this area.

A new system of switching and multiplying is used in this model. Variables whose resistance may be reduced by one-half or one-quarter by a range switch are used. If R1 and R2 are varied from full value to half value, the frequency will vary from a low

(Continued on page 72)

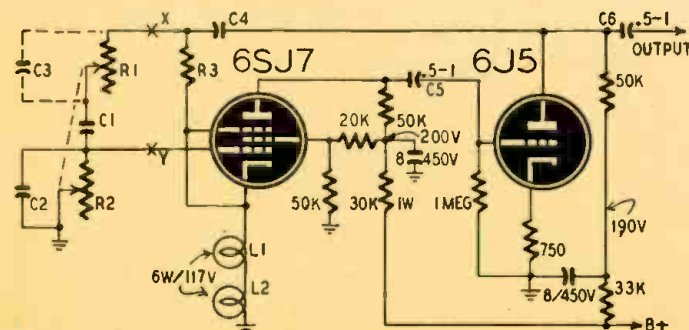

Fig. 1—Basic circuit of Wien oscillator as used in the instrument.

Radio Set and Service Review

Some unusual designs and developments



Right—
The Emor
One-World radio.

The Marcola
is strictly a
two-way receiver.



Front view of Hoffman A-700 portable radio.

POSTWAR radios have not actually presented the serviceman as many new problems as he anticipated during the crystal-gazing period of postwar planning. It appeared then that all future radios would be equipped with FM, television, wire and disc recording and a high-frequency transceiver to act as the home station for the family's mobile Citizens' radio, as a minimum.

Some of these things have come to pass. Before the end of this year, servicemen all over the United States will have the opportunity to work with FM receivers. Television, confined to the larger centers, is nevertheless spreading rapidly within its limits, and a number of firms are doing excellent business installing and servicing television receivers on a contract basis. The Citizens' radio is still in the future; but recent developments make it apparent that a low-drain tube capable of working in the 460-470-mc band may soon be with us.

Most novel feature of some of the new sets is their appearance. Radios in the shape of balls, radios concealed behind furniture-like panels until illuminated from within, Studebaker-like models which point both ways, and some receivers which cannot be described in terms of any geometrical figure, are seen on the market.

The military influence is also apparent in the tendency toward better mechanical construction, stronger frames,

and metal cabinets. The *General Electric* portable, with its die-cast aluminum frame, and some of the broadcast receivers put out by communications equipment concerns typify this influence.

A number of sets have novel features that are really functional. One of these is the *Emerson 1002-1003*. It combines in a 6-tube set a standard 5-tube superheterodyne and a special earphone output circuit for listeners who are hard of hearing. The earphone circuit has its own output tube, making it entirely independent of the loudspeaker channel. Its volume control is paralleled across the radio volume control, and there should be no interaction.

By turning the radio volume control completely down, the set may be used as a straight earphone receiver, a convenience for listening late at night or



Cabinet of the Crosley 56TD is unique.

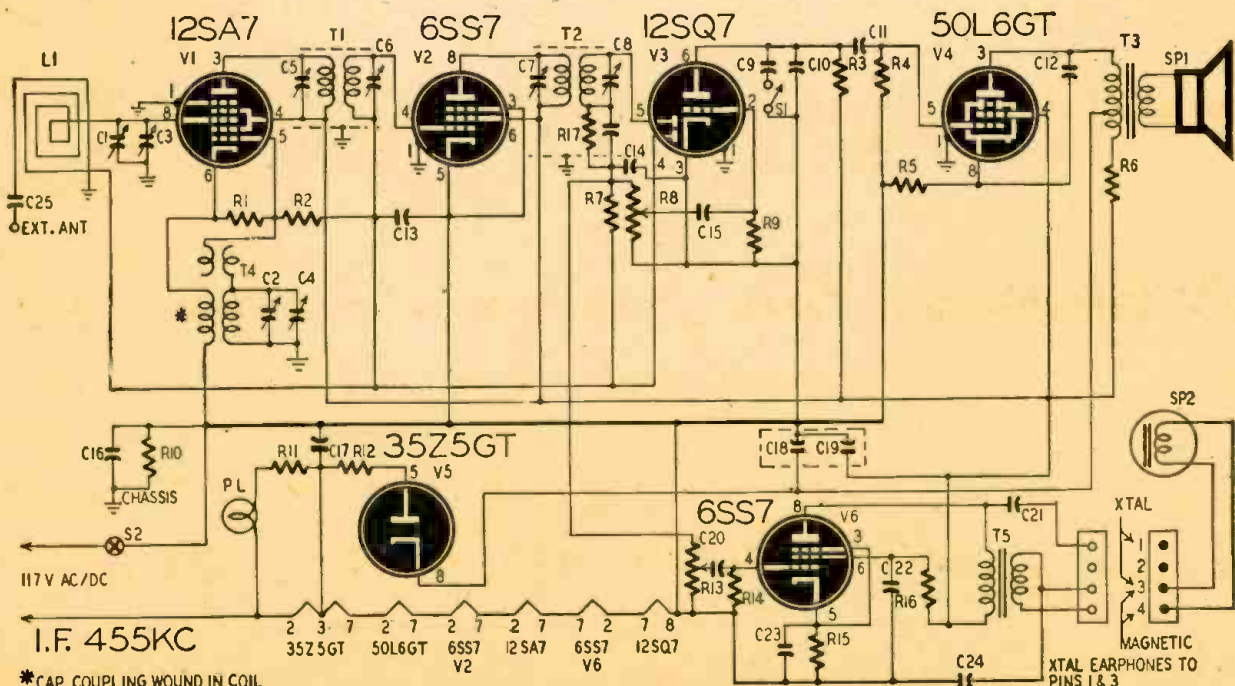

Fig. 1—Schematic of the Emerson 1002-1003. Two outputs are provided, to speaker and earphone, at different volume levels if desired.

in places where others might be disturbed or distracted by the sound. The earphone output circuit is so designed that either a crystal or magnetic phone may be used.

The receiver (Fig. 1) is otherwise a standard 5-tube superheterodyne, with a few special features which may interest the serviceman. The filter circuit is made up of part of the tapped output transformer and a 1,000-ohm resistor. The filter capacitors are 50 μf each, in a dual unit. Tone control for the radio is provided by switching in a 0.002- μf condenser from first audio plate to ground.

Another interesting receiver is the *Hoffman A-700*, shown in Fig. 2. The set has a loop hinged to the back so that it can be swung clear of the shielding effect of metal components for better signal pickup. Made by a Pacific coast firm, this feature is said to be especially important in the West, where large areas are at considerable distances from powerful broadcast stations.

The loop swings back into the set for use in city areas where signals are stronger. A special compensating circuit then couples to it (see L1, L2, in Fig. 2) to compensate for the detuning caused by closer proximity to metal chassis parts. Thus the set tunes correctly with the loop in either position. Rear of the set is shown in Fig. 3.

Other interesting features of the Hoffman receiver are the impedance-coupled r.f. stage, which uses permeability tuning, and the selenium rectifier. Originally marketed about a year ago, it was one of the first receivers to use this type of rectifier.

Servicing procedure is standard. The intermediate frequency is 455 kc. A cut-plate tuning condenser (365-180 μmf) is used, so there is no padder. The set uses resistance-capacity filtering. A 1,500-ohm, 6½-watt resistor and two 100- μf , 25-volt condensers filter the filament current. A 1,000-ohm, 1-watt re-

sistor and a 30-50- μf condenser pack constitute the high-voltage filter. All negative returns are made to a common bus, which is returned to chassis through a 0.2- μf condenser and 470,000 ohm resistor.

Another functional variation in radio set design is shown in Fig. 4. Made by the American Communications Corporation, this receiver is designed to fit into the wall and actually become part of the house. Two models are made, both with a pair of receptacles for plugging in electric appliances. The de luxe model incorporates a Telechron clock which can be set to turn on the radio at any desired time.

Built for its function of wall installation, depth of chassis is only 4 inches. The front panel measures 7½ x 16 inches. The radio is a standard 6-tube superheterodyne. Special louvers to dissipate heat are another feature which adapts it to wall installation.

The *Crosley 56TD* is "different" only in its cabinet. As can be seen in Fig. 5, the chassis is in no way modified to fit the case, though it does have to be mounted upside down, with the chassis up under the dial plate.

Cabinet variation is more extreme in the *Marcola* receiver, the radio without a back. Tuning knobs are on the top, and there are two identical dial windows on each of the long sides of the set. Speaker grilles are placed at the ends.

An even more unconventional re-
(Continued on page 74)

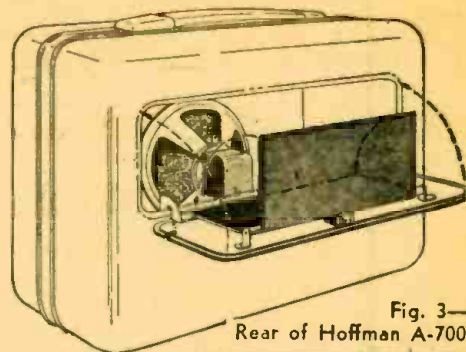

Fig. 3—Rear of Hoffman A-700.



Fig. 4—A wall radio, only 4 inches thick.

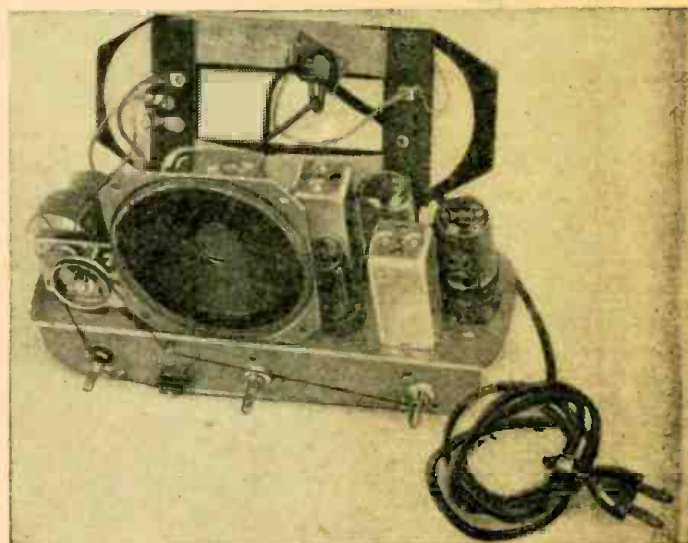

Fig. 5—Chassis view of the Crosley 56TD, with loop at rear.

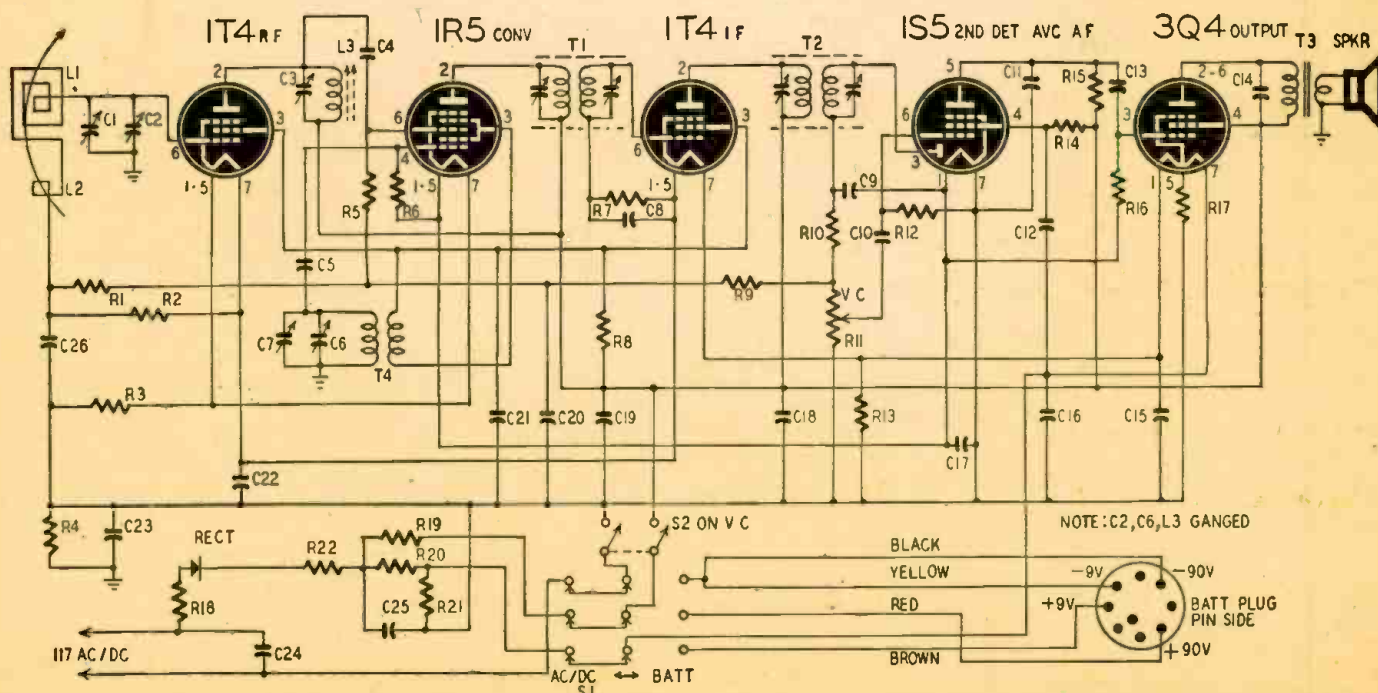

Fig. 2—The Hoffman A-700 is especially interesting because of its swinging antenna and the compensating circuit used with it.

ELECTRONIC COUNTING

• • • • Circuits and methods for counting and measuring



A commercial scale-of-64 counter used in radioactivity measurements.

Courtesy Atomic Instrument Co.

By JORDAN McQUAY

FOR the vast new electronic age now being ushered in by science and industry, many circuits have been developed that not only duplicate man's ability to count and measure but perform such functions instantaneously and with much greater accuracy.

As long as there is some measurable difference—time, size, color, etc.—between objects or quantities, electronic circuits can be constructed to distinguish such differences, lending themselves to preparation of that information for record.

The number of manufactured articles on a conveyor belt passing a given point may be counted, regardless of the speed of the operation. Color comparators can analyze, segregate, and identify paper and textile dyes, printing inks, and other color substances. Articles without a proper label or wrapping, or defective in shape or color, may be removed from the conveyor belt by another electronic device. Almost anything from fruit to nuts, nails, and needles can be graded and sorted according to shape, size, or color.

Control functions

Counting circuits receive and accept uniform input impulses, representing

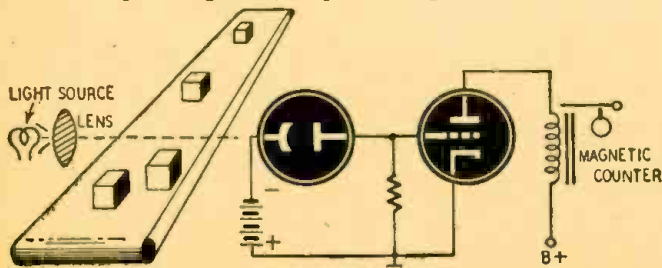

Fig. 1—Simplified schematic of standard phototube counting system.

units to be counted, and then produce an output voltage in proportion to that input frequency in such a way that the frequency of the transient phenomenon is enumerated accurately.

Impulses to be counted may come from a microphone, a phototube, an iconoscope, another electronic circuit, a manual- or motor-operated switching device, or other apparatus. Impulses can be tabulated at almost any rate of occurrence, depending upon the control function of a specific counting circuit.

Sorting circuits receive and compare two or more sets of impulses, representing two or more measurements of the size or color of the units to be sorted. Certain combinations of impulses automatically operate rejection machinery or switching apparatus, so that specific units are removed, rejected, or sorted. Sorting may be according to any combination of color, size, shape, or other variable factors.

Measuring circuits may use any of several electronic processes. Impulses of variable amplitude, representing proportional values of height, width, or weight of units under observation, are received and accepted by one type of measuring circuit in such a way that the amplitude is an accurate gauge of the unit under observation.

Other circuits, using the cathode-ray tube, measure time intervals and all transient phenomena with a time function, such as voltage, current, phase, wave forms, etc.

Modifications of basic radar circuits

measure distance, using the time function of radio waves in space and presenting reflected echo data on an oscilloscope.

Impulses applied to measuring circuits may be of constant amplitude and equally spaced, or they may be entirely random in nature.

Basic counter

In its simplest form, an electronic counting circuit provides one output pulse for any particular number—one or more—input pulses.

The output pulse can be either a current or voltage indication, depending upon the nature of the mechanical or electronic indicating device connected to the counting circuit. Often the output pulse triggers a blocking oscillator or one-shot multivibrator, or operates some type of recorder or visual indicator directly.

Input pulses may be obtained from a variety of sources: phototubes, television pickup tubes, electromechanical devices, or previous electronic circuits. These pulses are constant in amplitude; they vary only in recurrence frequency.

Phototube counter

A basic counting circuit which uses a triode is shown in Fig. 1. Source of input pulses is a phototube. The circuit actuates a relay, which in turn operates a magnetic or mechanical counting apparatus.

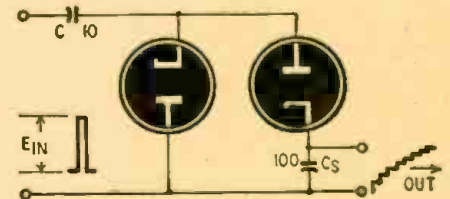

Fig. 2—Two diodes used in a "step counter."

Light entering the phototube causes continuous current flow. Current passing through the grid resistor creates a bias voltage which prevents the triode from conducting.

Interruption of the light beam reduces or removes grid bias, allowing the tube to conduct. Plate current flows, closing the output relay and operating the magnetic counter.

This counting circuit can be used in a variety of ways, as long as objects

(Continued on page 58)

Time Delay Control Circuits

By R. H. DORF, W2QMI

IN RADIO and electronic work we are accustomed to thinking in terms of almost instantaneous results wherever a flow of electrons is concerned. Since electronic energy does travel at the speed of light, we can often ignore—for practical purposes—the time delay between the start of electronic action and its end result.

Capacitors do take a finite time to charge. In r.f. and a.f. work, use is made of the small time intervals usually involved, but we often forget that electronic action may be delayed many seconds by simple RC circuits. Advantage may be taken of this fact in several fields. This circuit control can replace the mechanical delay relay, usually at a much lower cost; and the delay time can be controlled accurately over a wide range. Relays can be made to reciprocate, with the times of both make and break easily controlled by a simple variable resistor. A circuit can be completed manually—as by pushing a button—and then can be made to break itself automatically after a certain length of time. Such circuits are useful for transmitter control, actuation of light blinkers, photographic timing—in fact, in any use in which inexpensive, reliable, easily controlled time delays are valuable.

Fig. 1 shows the basic time-constant circuit, a resistor and capacitor in series

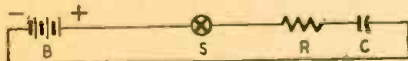

Fig. 1—The basic CR time-constant circuit.

with a voltage source, in this case, a battery. If we close the switch S and wait for the circuit to settle down, the voltage directly across the capacitor will equal the battery voltage. For d.c. the capacitor is an open circuit. There is, therefore, no current flow through R, and no voltage drop across it. The full battery voltage must be between the plates of the capacitor.

But note that this is only a voltage. If we attempt to take power from across the capacitor into a resistive load, the circuit will be as in Fig. 2. RL and R constitute ordinary series loads across the battery, the capacitor loses its effect, and the voltages in R and RL divide in the ratio of the resistances.

Consider what happens when we close the switch in Fig. 1. The positive side of the battery attracts electrons from the top plate of the capacitor. They are deposited on the bottom plate, creating the difference of voltage be-

tween the two plates, which charges the capacitor. The electrons must travel through the resistor, creating a voltage drop across it. This voltage drop prevents the full battery voltage from being applied to the condenser plates. But, as the condenser charges, the electron stream tapers off and the drop across the resistor diminishes, allowing more voltage to be applied to the capacitor. This, in turn, keeps the electrons flowing. When the maximum number of electrons—determined by the condenser's capacitance—have been taken from the top plate and deposited on the bottom plate, there is no further IR drop across the resistor, and full battery voltage appears across the charged condenser.

The time required for this whole operation depends upon the capacitance of

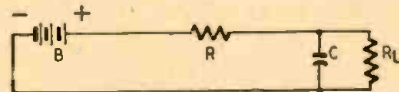

Fig. 2—Effect of loading circuit of Fig. 1.

the condenser and the resistance of R. If C is increased (the plates being made larger or the separation smaller), more electrons will be displaced from the top to the bottom plate; the IR drop across the resistor will increase, and full condenser charge will be delayed. If C is decreased, fewer electrons can flow, and the process is hastened.

Considering R: if the resistance is increased, the voltage drop across it is larger for a given electron stream; and less voltage is applied to the condenser at any given time after switch closure than before. If R is smaller, its IR drop is less at a comparable time after the initial application of battery voltage; and the condenser charges more quickly.

The mathematics required to calculate the time for full condenser charge are extremely simple. The formula is: $t = RC$, with t in seconds, R in ohms, and C in farads. (For control purposes, it is simpler to use C in microfarads and R in megohms.) The time t is the number of seconds after initial application of battery voltage required for the potential across C to reach approximately 63% of the battery voltage.

When the condenser is discharged, the entire process is reversed. The electrons flow from the bottom to the top plate, through R. The time required to reduce the condenser charge (and the voltage across it) to a given level is again dependent upon R and C. The same for-

mula is used, but t represents the time required for the condenser to retrogress from full potential to about 63% of full voltage. In practice, the discharge time is very slightly less than charging time, due to the leakages in the condenser structure. If a condenser could be built which would retain its charge indefinitely when disconnected from the charging

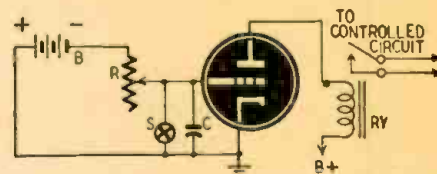

Fig. 3—The simplest time-constant control.

battery, the charge and discharge times in the time-constant circuit would be exactly equal. The difference is not usually important.

Having constructed a circuit which will produce an electrical delay, how are we to make use of it? It must be remembered that the voltage across the capacitor must not be shunted by any current-drawing load. The use of a vacuum-tube grid circuit is usually dictated.

Fig. 3 shows a basic time-constant control circuit. The grid of the tube is connected through the resistor R to the battery B, the positive end of which is grounded. The tube is biased by the battery to or beyond the point at which plate current is too small to close the plate circuit relay RY. The contacts are therefore open. The condenser from grid to ground, being an open circuit to d.c., does not affect this condition after it has charged.

If we now close switch S, the condenser discharges almost immediately; the grid is grounded. At the resultant zero bias, plate current is large enough to close the relay. When the switch is opened, the short across the condenser is removed. But the grid-to-ground potential required for plate current cut-off is delayed, due to the time required for the condenser to charge in the RC circuit; and the opening of the relay contacts is delayed by a number of seconds determined by R, C and the battery voltage.

If the battery voltage is so chosen that a grid voltage of about 63% of its value will cause the relay to open, then a resistance of 1 megohm and a capacitance of 1 microfarad will cause a delay of 1 second. If the battery is larger,

(Continued on page 61)

250-Watt FM-AM Transmitter

PART II—Construction of the r.f. section

By HARRY D. HOOTON, W3KPX

CONSTRUCTION of a 250-watt transmitter such as this one is simple. The layout of the various components shown in the photographs (in this and last month's installments) is one of the best and, unless the constructor has had considerable experience with complex circuits, should not be changed. The wiring between the various parts of the transmitter must be kept short and direct. The r.f. circuits are wired with No.

14, tinned copper, round bus wire. Do not make sharp bends in the plate or grid leads; keep these leads well separated and away from the chassis.

The low-impedance leads, such as the filament wiring and the link lines between the feed-through insulators and the links of the various coils, may be made of insulated stranded wire, twisted and dressed close to the chassis to reduce their external fields. *It is of utmost importance that all wiring which*

carries a.c. be kept away from the FM speech-amplifier circuits and the control grid of the 6SJ7 reactance tube. Any stray 60-cycle current will cause frequency modulation of the emitted carrier. It may be necessary to redress some of the audio-frequency leads or to shield them in order to eliminate hum pickup completely. The d.c. plate and screen voltages for the 6F6-G oscillator, the 6SJ7 reactance tube, and the speech amplifier must be adequately filtered.

A good check for frequency deviation due to 60-cycle hum is to tune in the oscillator carrier on a regular AM communications receiver which has its b.f.o. turned on. Any hum modulation will show up as a waver in the audio beat note from the receiver. The oscillator signal should be sharp, clean, and well defined when no audio voltage is fed to the control grid of the reactance tube.

The 6F6-G may be used as a crystal-controlled oscillator for AM phone or c.w. For FM it is used as a stabilized variable-frequency oscillator. The plate tank circuit is then tuned to twice the grid-circuit frequency; for crystal-control operation, the plate tank circuit is tuned to the same frequency as that of the crystal in use.

For regular v.f.o. operation on AM phone or c.w. plate and screen voltages are removed from the 6F6-G and its associated FM circuits, and the r.f. excitation voltage is fed to a link on the 6F6-G plate coil, which is also in the grid circuit of the TB-35.

Immediately following the 6F6-G is the Taylor TB-35 beam-power tetrode. This is a medium-power tube which was placed on the market after the war. The TB-35 is very easy to drive, may be operated "straight through" without parasitics or oscillation, and makes an excellent frequency multiplier. Although

(Continued on page 68)

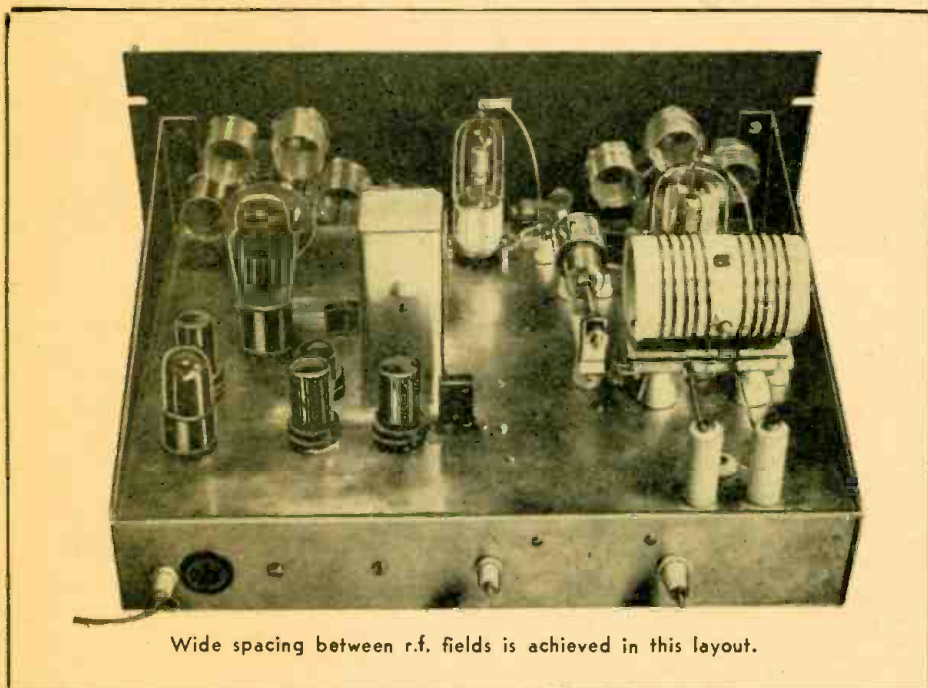

Wide spacing between r.f. fields is achieved in this layout.

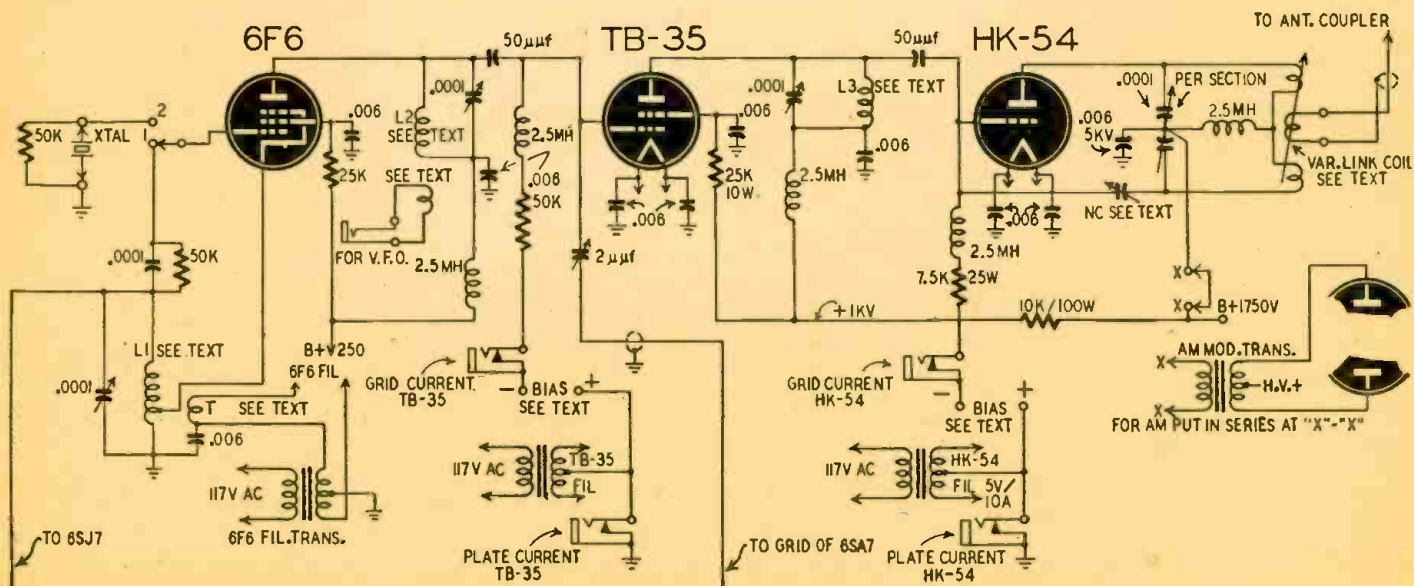

Fig. 1 The leads running down "to 6SJ7" and "to 6SA7" connect to leads on last month's schematic, and tie in the transmitter's FM section.

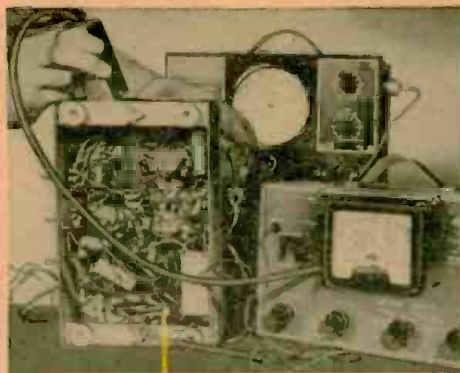
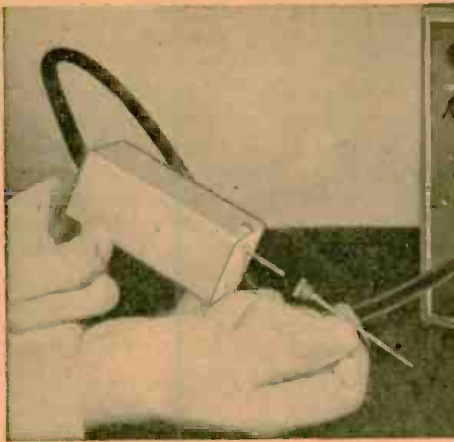

Photo 1, left—Extension for the probe tip.
Photo 2, above—The 6A8 circuit proved O.K.

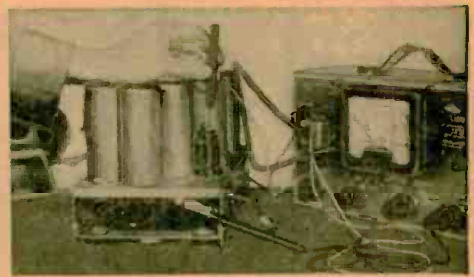

Photo 5—Grid to ground shows a dead short.

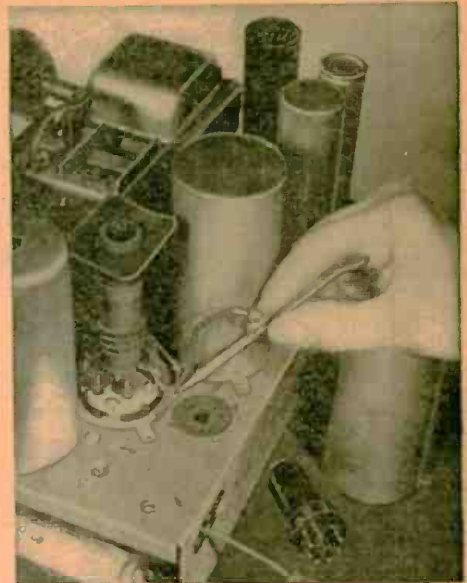

Photo 6—Visual inspection locates the short.

Quick Fault Finding

By H. E. LEEPER

A GENERAL ELECTRIC Model A-63 receiver was being serviced. By a disturbance test at the 6H6 detector-a.v.c. tube it was found that the audio section was operating.

Since no signal could be received, the vacuum-tube volt-ohmmeter illustrated was used to locate the defect in the stages preceding the audio section.

The r.f. probe tip on this instrument is less than 1 inch in length. To reach the plate terminal of some of the tubes, an extension was made for the probe as shown in Photo 1. A piece of No. 12 bare wire, about 2 inches in length, was soldered to the top of a phone jack. The jack was a small one, of the type used on meters, and was drilled out so that the probe tip would fit and stay in place while using.

This extension reduces the sensitivity of the meter, but by using a strong signal from a signal generator, satisfactory indications were obtained at the tube plate terminals.

The arrangement shown in Photo 2 was made, with a signal generator con-

nected to the aerial and chassis of the receiver, the common ground lead of the volt-ohmmeter attached to the chassis, and the r.f. probe contacted to the plate of the 6A8 converter-oscillator tube. (This receiver has the following tube complement: Converter-osc. 6A8, i.f. amp 6K7, det-a.v.c. 6H6, audio-amp 6C5, output 6J7, rect. 5Z4.)

The volt-ohmmeter was set on the a.c. 30-volt scale and the signal generator controls were advanced to maximum. The signal generator's tuning control was then varied—since the r.f. probe detunes the radio circuit slightly—until maximum reading on the meter was obtained as shown in Photo 2.

Because of the probe extension and possible a.c. pickup this reading may not have been accurate as read on the meter, but this was of no consequence as the fact that such reading would change as the signal from the generator was tuned in and out proved that the radio circuit was passing the signal to this point—the plate of the first tube.

The r.f. probe was then moved to the plate terminal of the second tube—the

6K7 i.f.-amp. tube as shown in Photo 3.

The above tuning procedure was repeated but this time no movement of the meter indicator resulted. It was evident that the defect was between the plate circuits of these two tubes.

The meter was then set to read ohms and a reading taken from the plate of the 6K7 i.f. and amplifier tube to chassis, as in Photo 4. This test showed approximately 40,000 ohms, which checked fairly closely with the value on the wiring diagram.

The ohmmeter was then attached from the grid of the same tube to chassis as in Photo 5, and zero resistance was found.

(Continued on page 71)

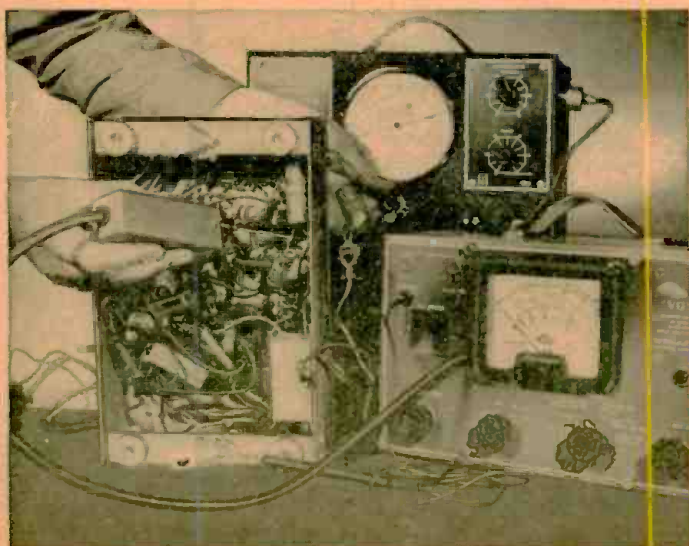
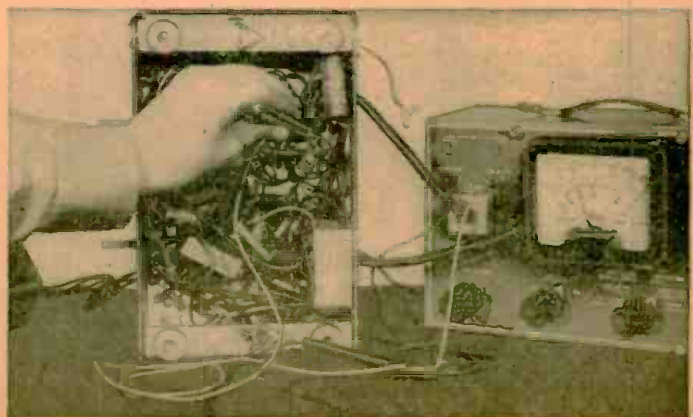

Photo 3, left—No signal is indicated at the i.f. tube output.

Photo 4, below—Using the Vomax as ohmmeter to find the bad part.





Mr. Tannehill at his own repair bench. Small parts are kept in jars on top shelf—just out of sight—and entire tube stock is at left. Dealer servicing permits these very small inventories.

Dealer Service Builds Volume

By JACK TANNEHILL

If you have been a little discouraged with a small volume of part-time radio repair work, or if you feel ambitious and want to expand your present part-time shop, here is a plan which was worked out and is being put to practical use by the writer. Besides bringing in a large volume of repair work, it offers many money-saving and time-saving ideas that have proven their worth in making a part-time radio repair shop a profitable business.

Many spare-time radio repair benches are barren countless days of the year and they often become little more than a hobby for the radio enthusiast. But if a radioman has the necessary experience and technical background to back up this plan, he can keep busy at the bench for as much of his spare time as he desires.

Personal experience has shown which are best of many possible ways of getting a steady flow of repair work. The neighborhood sign in front of the home, while it is important in identifying oneself, at best will attract people only in the immediate vicinity and probably will not bring in more than a dozen receivers a month. Exceptions of course are the shops that have been established for a long time and are well known, or those which are located on a street where a great deal of traffic passes.

Door to door leg work will bring some results, but too much time must be devoted to this method. Direct-mail advertising, while inexpensive and easy, in the author's experience was not an effective means of getting repair business. Local newspaper advertising may be a good medium, depending on the

community served. To be worth while, it must be continuous; and it soon becomes an expensive item.

Dealer servicing

But the best method yet developed, and one which is guaranteed to bring in plenty of work, is wholesaling! Wholesaling radio repair work on a large scale is not new, but it is not often encountered in a spare-time business. Perhaps the part-time devotee does not feel up to the responsibilities wholesaling might entail, or he feels his profit margin will be small. Wholesaling will cut slightly into the profit per job, but the much greater volume it brings will more than offset that; and it can very easily be the method of making your repair business worth-while and profitable.

Believing that this is an advisable plan to follow, how can one establish himself as a part-time wholesale radio repairman? Taking for granted that you are capable as well as desirous of expanding a part-time business, your first step is to make contacts with several reputable retail outlets that feature radio and appliance sales in your community. Try to interest the proprietors in a radio repair service setup in which you will do the repair work for them on a wholesale basis, the service to be advertised under their name, as their own service. Choose one, or even two, of these who appear sympathetic with your idea. Naturally you will choose firms with established reputations, that are aggressive in their appliance sales, and that have a full line of new radios to sell.

Your approach in selling this idea to

a merchant should be to show him the advantages in having a service department of his own. Stress the fact that the service will bring additional traffic into the store, that it will be a great help to him in selling new radios, that it will lead to closer cooperation with distributors who naturally favor service-dealers over dealers without a service department. Mention the fact that he will have someone available to service the new radios sold by the store and which are coming back for repair, thus eliminating the wait on replacements and adjustments by distributors. Last but not least is the income the merchant will derive from his commissions or markups on the repair jobs. This is a substantial item and more than pays for his time in handling the incoming repair jobs, collecting, etc.

Agreement and records

No written agreement or contract is in effect between the service shop and the retail store; it might be a good thing to have, but a merchant usually does not want to be burdened with such detail. Repair tickets have been printed, and one is kept at all times with each radio brought in. The dealer in this case happens to be very co-operative and, if he can, he learns the complaints of the customers and notes these on the reverse of the repair ticket together with any wishes of the customers, special work required, etc. Arrangements are made to pick up radios to be repaired at the closing time of the store each day. They are returned to the store the next morning if possible. A local delivery service has been found useful in making these pickups and returns, for a very small fee each week. This is a great help since the repairman is not always able to get to the store in time to pick up the repair jobs before closing time. This delivery service is also used to pick up large radios at customers' homes, and thus helps to cut down on home service calls.

Closer and more elaborate bookkeeping is necessary in these associations than might be needed by a repairman working independently. An invoice is issued to the store for each repair job, covering the wholesale charges to the store, and an entry is made in a ledger for each invoice. This same entry includes the date, the customer's name, radio model number, and work performed. The work performed need not appear on the invoice but can be shown on the repair ticket kept with the radio. A notation is made beside each entry in the ledger when the invoices are paid by the store. Collections can be made from the store monthly or weekly and each invoice that is paid is marked and initialed for the store's records. Repair tickets, invoices, and statements with your name printed on them can be

(Continued on page 63)

Decade Box For Capacity Tests

FOR the average ham, experimenter, serviceman, or owner of an amateur laboratory the measurement of values of voltage, current, resistance, capacitance, and inductance presents no great problem. With the garden variety of volt-ohmmeter plus maybe a simple form of capacitance and inductance bridge it has been possible to measure these quantities with speed and a degree of accuracy sufficiently high for ordinary uses.

Developments of the war period plus postwar progress have opened to the specialized technician fields which were hardly dreamed of a few years ago. The technician who is conversant with the trend realizes that the old days of approximation of values is fast disappearing. Even now the demand for oscilloscopes, high-range voltmeters and ohmmeters, vacuum-tube voltmeters, and signal generators which will cope with the requirements of these new developments far exceeds the supply. It is just as evident that even greater accuracy will be necessary as time goes on. With these concepts in mind we present a capacitance decade which should be a "must" for the workbench of the serious radio man.

For the radio serviceman, its uses are many as a substitute capacitor in receivers, amplifiers, and similar apparatus. Clipped into control circuits it will afford a better check on the value that should be replaced. Similarly used in coupling or by-pass circuits, it will become increasingly valuable as an aid to improving already operating receivers, and as a speedy servicing tool.

The precision of a unit of this type is dependent upon the accuracy of the components used in its construction.

By R. L. PARMENTER, W1XJF

This in turn will depend upon the requirements of the user as well as the amount of money expendable. One leading manufacturer of laboratory standards produces a decade with only three-quarters the range of this unit with a tolerance of 1%. The price closely approaches \$100, which is probably more than the average serviceman would care to pay. On the other hand a leading capacitor manufacturer turns out decades with 5% tolerance at a cost of approximately \$14. The cost of this unit will be somewhere between these two values depending upon the components used.

Construction of a capacitance decade should present no great difficulties to either the beginner or experienced builder. However, a few things should be kept in mind when choosing components and in the actual wiring. Since this unit has capacitance values which are relatively small, all stray capacitances *must be kept to a minimum* if accuracy is to be retained. When wiring, use bus bar to maintain the best possible stability. Do not permit any two conductors to run closely parallel to each other. All joints must be well soldered and should be mechanically solid before soldering, so as to prevent errors from creeping in as time goes on.

For the switches used we cannot recommend too strongly the General Radio Type 380-PS. This is a switch which has been especially developed for its low capacity, low loss, and positive contact as well as for convenience of operation.

In this unit the 4 capacitors used are wired to their respective terminals, and construction of the switch permits paralleling the proper values so that merely rotating the pointer will provide a sequence of values of 1 through 10, in their proper order. This is obviously a very great advantage as far as ease

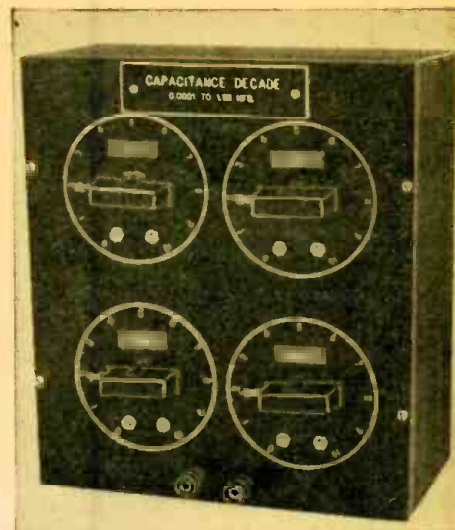

of operation is concerned. These switches are provided with pointer, dial plate and mounting screws and stops, and present a professional appearance when mounted on the panel. However, if the cost of these units does seem prohibitively high, then toggle switches may be used at a considerable saving, keeping in mind, however, that stray capacitance may be picked up and poor contacts may cause trouble. Closing 1 or 2 switches will give any value between 1 and 10.

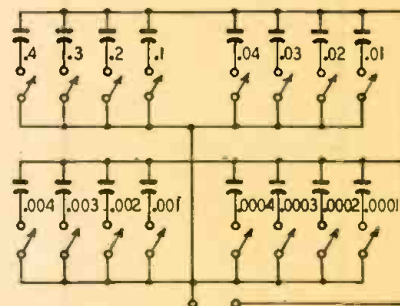

Schematic diagram of the capacity checker.

We have not gone into details of construction. The simplicity of the unit makes it unnecessary. We believe that a decade of this type will find increasing favor and use in the workshop of the serious radio and electronics worker as time goes on and the demand for greater accuracy and precision standards becomes more necessary.

Parts List

- Switches**
 4 General Radio Type 380-PS, complete with pointers, dial plates and screws; or 16 toggle switches (anticapacity type if possible).
- Capacitors**
 1 each—Aerovox silver micas, Type 1,479, 1,000 v test (standard tolerance 5%, but may be had up to 1% at additional cost.)
 0.0001, 0.0002, 0.0003, 0.0004
 0.001, 0.002, 0.003, 0.004
 1 each—Aerovox standard micas, Type 1,650, 1,000 v test 0.01, 0.02, 0.03, 0.04 or
 1 each—Aerovox midget, tubular, metal-cased paper, oil impregnated, and oil-filled, Type 689, 600 v.
 Aerovox tubulars, Type 684, 600 v (These come in values of 0.1, 0.2, 0.15, and 0.25, so values should be selected to make up units measuring 0.1, 0.2, 0.3 and 0.4.)
 (All the above capacitors should be selected at your jobber's by measuring them against a capacitance bridge, or have your jobber order them special from the manufacturer at the tolerance desired.)
 1 bakelite panel 8 x 9 inches
 1 cabinet 8 x 9 x 4 inches
 2 binding posts—Eby combination type; wire, phone tips, or banana plugs.

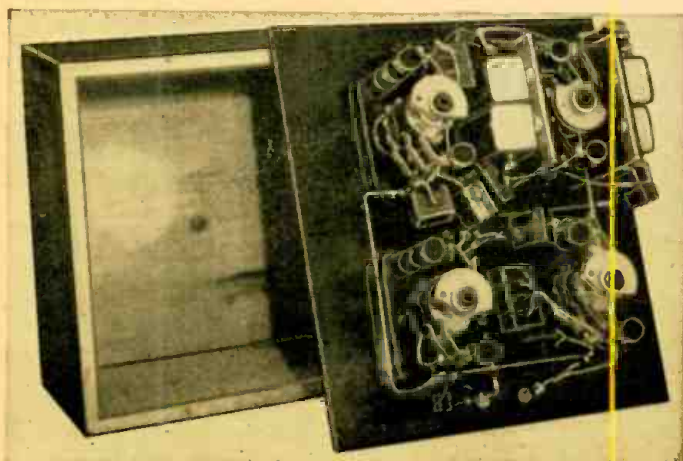

Back-panel view, showing the four special low-capacity switches.

Ultrasonics, the study of mechanical vibrations above the human hearing range, is finding new and important applications.

ULTRASONIC PRINCIPLES AND CIRCUITS

ULTRASONICS, or supersonics, is the study of those vibrations of air, water, metal, or other medium that occur at a rate so fast that they cannot be heard by the human ear. The average human ear can hear as sound air vibrations of frequencies from about 30 to 15,000 cycles per second. Other vibrations of from 15,000 to 25,000 cycles are perceptible by some people, not as sound but as "characteristics" or timbre of some lower-fre-

By J. W. STRAEDE

duces waves more like a parallel beam which spreads out to an almost negligible extent. The variation of directional characteristic with frequency is shown in Fig. 2.

Ultrasonic vibration occurs in nature. Some of the higher-frequency air vibrations produced by a cricket are inaudible to the human ear but can be detected by a special type of microphone. Some animals have the ability to hear these extremely high (20,000- to 45,000-cycle) frequencies. The obstacle-avoiding system of the bat is an ultrasonic equivalent of radar. (*Radar, Bats, and Supersonics*, RADIO-CRAFT, April, 1945.)

Generation of ultrasonics

Early methods of generating ultrasonic vibration in the laboratory included the use of whistles, driven by compressed air, and the rubbing of a metal rod, the natural frequency of which was above the audio range. Today, this high-frequency vibration is produced by a vacuum-tube oscillator of a type intermediate between r.f. and a.f. and a suitable "loudspeaker." The latter is usually one of three types:

1. ribbon (something like an overgrown ribbon "mike"),
2. piezoelectric,
3. magnetostrictive.

The second type has been used as a "tweeter" for wide-range audio amplification and depends for its action on the change in shape of a quartz, tourmaline, or rochelle salt crystal in an electric field. The magnetostrictive generator consists of a nickel, cobalt, or iron rod, around which high-frequency current flows in a coil. The rod vibrates longitudinally, changing its length according to the current. At one end of the rod is fastened an aluminum disk or diaphragm, about two inches in diam-



Fig. 2—High-frequency waves are directional.

eter. Instead of a rod, a roll of nickel foil or a number of laminations can be used to reduce the eddy current loss. The resonant frequency of a magnetostrictive rod is almost inversely proportional to its length.

Condenser loudspeakers with tiny, very tightly stretched diaphragms have also been used.

Typical h.f. oscillators and ultrasonic generators are shown in Figs. 3 and 4. In Fig. 3-a, L and C are chosen to resonate at the desired frequency. The coils in Fig. 3-b are less critical, but may have a natural resonant frequency near that of the rod.

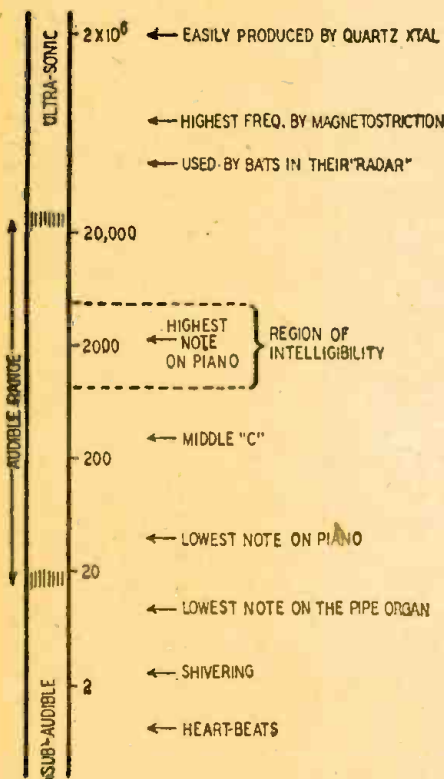

Fig. 1—Spectrum of mechanical vibration.

quency vibration. Fig. 1 is the sonic and ultrasonic vibration spectrum. Ultrasonic vibration is interesting to radio experimenters, not only because its generation and detection usually involve electronic devices and because of its employment in some systems of television, but also because the theory of ultrasonics is very similar to that of the higher audio frequencies often sought after in radio and amplifier design but very rarely attained.

Most radio experimenters know that the higher audio frequencies are emitted over only a small angle from a loudspeaker diaphragm. At ultrasonic frequencies, a pulsating diaphragm pro-

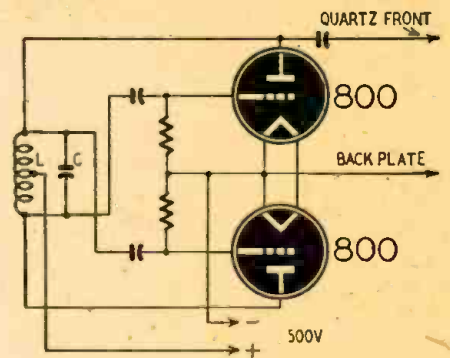

Fig. 3-a—A circuit for a quartz transducer.

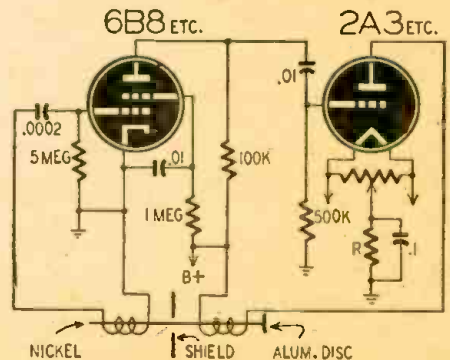

Fig. 3-b—Low-power magnetostrictive circuit.

Ultrasonic vibration in metal has been detected by the presence of ripples in a pool of oil on its surface, in air by its cooling effect on a platinum-resistance thermometer, and in liquids by suitable types of microphones. The latter, of course, can also be used to detect air vibrations. Ultrasonic vibration in air will deflect a Rayleigh disk just as sound does.

The microphone is connected to an amplifier designed on the lines of the video amplifier in television, i.e., designed so that the higher frequencies are NOT attenuated.

High-frequency microphones

Various types of microphones are employed. Crystal microphones of the

(Continued on page 66)

Miller-Effect FM

How a former annoyance can be put to work

by HAROLD E. ENNES

BEFORE automatic frequency-control circuits and frequency modulation were developed, Miller Effect was considered only a troublesome characteristic of vacuum tubes, to be overcome by certain circuit modifications. The Miller effect, or the effect of tube gain on the dynamic input capacitance of a vacuum tube, has recently been put to useful work in a number of ways, and has particularly interesting possibilities as to producing frequency modulation in the simplest possible manner. At least one commercial FM manufacturer uses the Miller effect in the modulator circuits¹.

The dynamic input capacitance of a triode depends not only upon the grid-cathode and stray capacitance, but also upon the product of the grid-plate capacitance and voltage amplification of the tube². Thus the actual input capacitance of a triode under operating conditions becomes:

$$\text{Input capacitance} = C_k + C_p (1 + A \cos \theta)$$

where C_k = grid-cathode tube capacitance,
 C_p = grid-plate capacitance,
 A = voltage amplification of tube alone
 $\left(\frac{E_p}{E_g}\right)$,

θ = phase angle of load impedance in plate circuit.

With a resistive load in the plate circuit, we may omit $\cos \theta$ from the formula, since θ would become zero and $\cos \theta = 1$. Our formula then becomes:

Input capacitance = $C_k + C_p (A + 1)$. Thus it can be seen that the input capacitance will depend largely upon the magnitude of A , the voltage amplification of the tube.

For pentodes we have an additional capacitance of the grid screen (C_s) which must be considered, and the formula (for resistive load) becomes:

Input capacitance $C_i = C_k + C_s + C_p (A + 1)$.

The component $C_p (A + 1)$ now becomes the smallest factor of the three, because of the small amount of grid-plate capacitance in a pentode; but since the amplification may become quite large, the factor is very important in frequency-control systems.

The simplified schematic of Fig. 1 shows how this effect is used by Federal Telephone and Radio Corporation for frequency modulation in their transmitter. In this circuit, the Hartley oscillator, using a 12J5, has the grid circuit of a modulator tube (6AB7) shunted across a portion of the tank circuit which comprises the frequency-determining component. Audio voltage applied to the grid of the modulator varies

the grid bias of the tube, effectively changing the input admittance. With a resistive load, the input admittance is purely capacitive, and the effective input capacitance, varying in accordance with the audio voltage, frequency-modulates the oscillator tube.

The Miller effect provides a number of possibilities for the experimenter both for production of FM and the stabilization of the center frequency. It can be used in highly simplified circuits entirely suitable for amateur FM transmitters.

The electron-coupled oscillator, for example, may be thus adapted. Changing its screen or plate voltage causes a shift of frequency, but in opposite directions. That is, an increase in screen voltage causes a decrease in resonant frequency, and an increase in plate voltage causes an increase in resonant frequency. For this reason, where the ratio of voltages on screen and plate—taken

from a common bleeder supply—is correct, small deviations of plate supply voltages do not affect the operating frequency, because of the compensating action of the two parameters. It is obvious that modulation of any element of the tube would cause both frequency and amplitude modulation, the amplitude modulation being removed by following class-C stages of the transmitter. Simultaneous modulation of the screen and plate circuits would produce FM with very slight modulating voltage.

The important problem involved in this procedure is finding the correct ratio of operating voltages to allow a linear change of frequency with amplitude of modulation. The amount of frequency deviation for communication and amateur purposes need not be more than about 15 kc or 7.5 kc on either side of the mean carrier value. The amount of frequency deviation for a given mod-
(Continued on page 47)

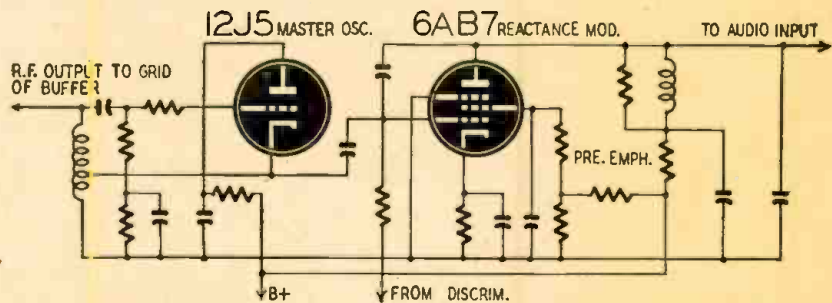
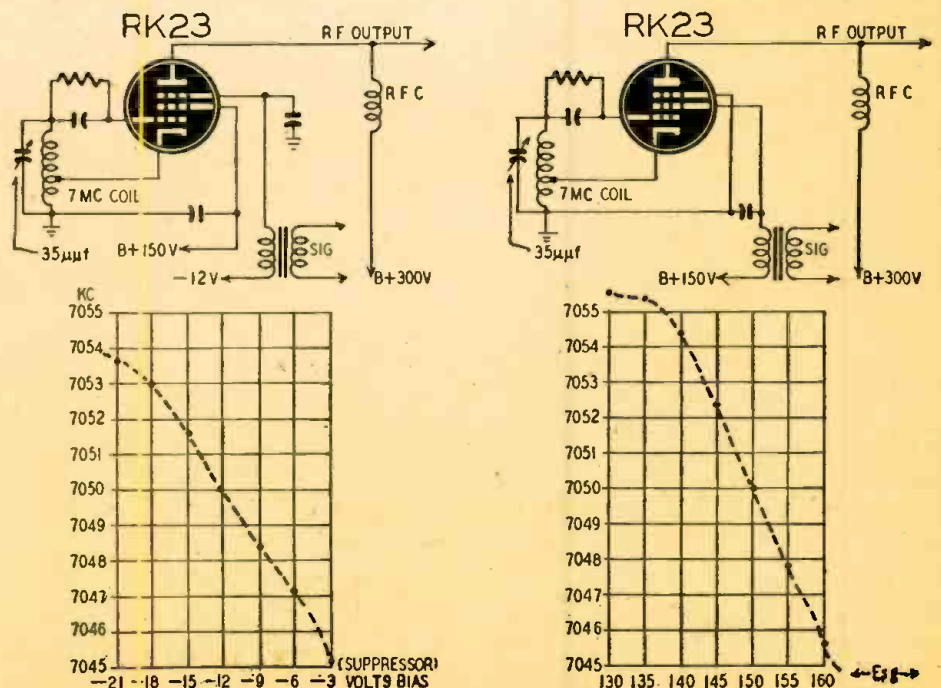
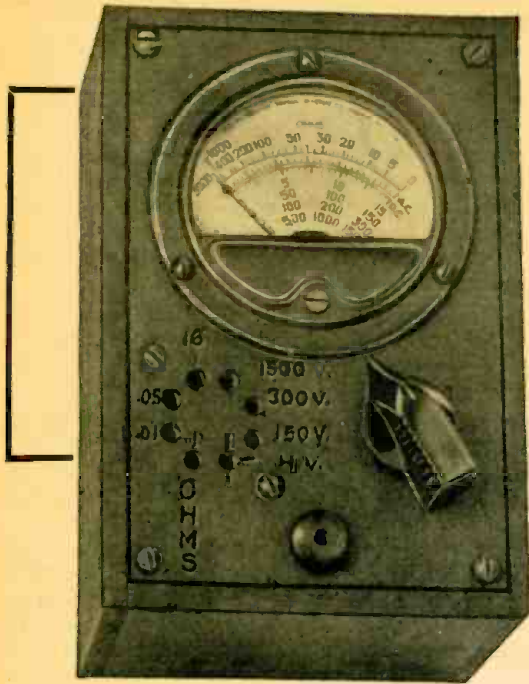

Fig. 1—Stabilizing circuit used by Federal. This was described in RADIO-CRAFT May, 1946.



Figs. 2 and 3—Frequency change vs. change in suppressor and screen voltages respectively.

1. Federal Telephone & Radio Corp.
 2. Terman: *Radio Engineers' Handbook* (pp. 468-472)



A Volt-Ohmmeter Without Switches

By RALPH BLOOM

WITH the price of good test equipment what it is today, the part-time radio serviceman may find it better to have a homemade tester than no tester at all.

This volt-ohmmeter was constructed with parts obtained mainly from the junk-box (may it always be overflowing, God bless it). The case was originally a cheese box that was taken apart very carefully so as not to split the wood. It was then cut to the desired size, nailed and glued together, the brand-name markings being left on the inside, and given a good sandpapering. It was then given a coat of dark mahogany

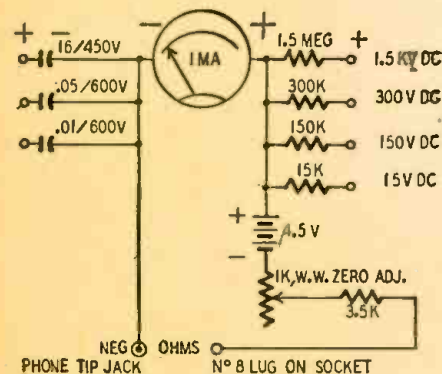

Fig. 1—Circuit includes 3 test condensers.

stain. The outside dimensions of the case are: length, 5 inches; height, 2 3/4 inches; width, 3 1/2 inches.

It is also advisable to drive in 4 rubber-headed nails at the bottom corners of the case to prevent it from marring a customer's radio cabinet, when checking a radio in his home. They also give the tester a more professional appearance.

Wiring this tester should not be difficult, but as a precaution, before testing any source of voltage, make certain that all the connections are wired correctly, otherwise you might possibly burn out the meter. Fig. 1 is self-explanatory.

The range selector switch is nothing more than an octal-wafer tube socket that was placed under the top panel and in which 1/8-inch holes were drilled to match the holes of the octal socket. To select the range all you have to do is to plug one of the test leads into the desired hole of the tube socket.

The meter is 2-inch size, 1,000 ohms per volt, 0-1 ma. The original scale was not suitable for a volt-ohmmeter, so a meter scale of the type shown was obtained and glued on top of the original one.

The zero-ohms adjuster is a 1,000-ohm wire-wound control, salvaged from an old discarded tester. The ohmmeter range is 0-300,000 ohms. The d.c. voltage ranges are 0-15/150/300/1,500 volts. The resistors used to construct this tester should be as accurate as can be obtained; they should be rated 1/2 to 1 watt. The insulated type is preferable, to prevent the possibility of a short circuit.

Besides being used as a volt-ohmmeter, this tester has at least one other function—3 condensers are placed inside the case with one end of each terminating at the range selector switch. The built-in condensers are a considerable time saver. Instead of having to hunt for a condenser to jump the suspected defective one, you will always have the most popular sizes right in your tester.

The capacitance sizes were chosen very carefully to get the most efficiency from the smallest number of condensers in the case. There is a 16- μ f, 450-v, tubular condenser that can be utilized to jump across almost any filter condenser you may suspect to be open. There is also a 0.05- μ f, 600-v condenser that can be used as a substitute for a bypass, line, a.v.c., blocking, coupling, or audio decoupling condenser. Finally, there is a 0.01- μ f, 600-v condenser that can be used as a substitute for a coupling or plate condenser. If condensers are not needed, the points can be used for other test purposes.

The various range settings on the tube socket are arranged as shown in Fig. 2. The negative tipjack test lead does not have to be removed for any range you may wish to select. This adds

to the convenience of operating the tester.

This system is cheaper and more compact than using a switch, and is far quicker to wire up when constructing the meter. It is also safer to use than a switch type, as there is less danger of putting the pin in a wrong jack than there is of turning the more-easily moved switch to a wrong point.

The batteries are the pen-light type, which will probably last much longer than a year with normal usage.

This tester, because of its simplicity and low construction cost, should prove highly useful to many newcomers in radio. Even old-time radio servicemen who don't want their good test equipment subjected to unnecessary abuse

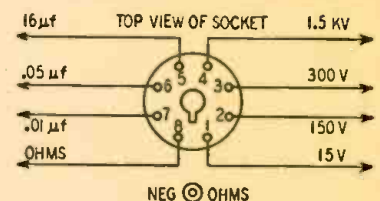
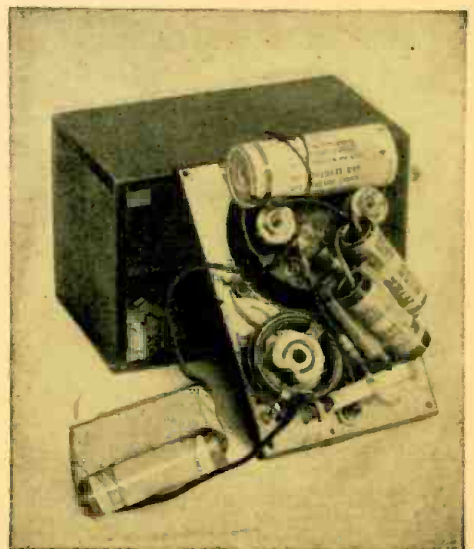

Fig. 2—Connections to the socket terminal.

might find it useful as a pocket-sized portable meter for their outside service calls, as it enables them to have both hands free to carry a radio chassis. It may also be used in the repair shop as a spare test meter.



An interior view, showing the extra condensers.

Travellers' 2-Tuber

By WILLIAM G. BEAMAN

HERE is a two-tube a.c.-d.c. mid-gut containing a minimum of parts which can be packed neatly in a suitcase or overnight bag. It has given loudspeaker reception above expectations at such widely separated points as Honolulu, San Francisco and Detroit. About the size of a box camera and weighing a little over two pounds, the *Separation Special* has worked well everywhere it has been tried except in a Pullman car washroom, where efforts to pick up the final game of the World's Series, using the electric razor current, proved futile.

Designed and completed in a week when the author* was in Honolulu contemplating early return to civilian status, the tube line-up was determined by what was available there at the time. It turned out to be a somewhat unlikely combination of a 117L7-GT as rectifier and beam power amplifier and a 3A8-GT with the pentode section as r.f. amplifier and the triode as a plate detector.

The 3A8 also contains a diode, but experiments proved that circuits using it as a detector—with the triode as first audio amplifier—did not give results comparable to the final design.

The problem of obtaining a 50-ma d.c. for the 3A8 filament was solved by placing the filament in the cathode circuit of the 117L7 (beam power section). The 3A8 filament is not only heated to the proper value by the 50-ma cathode current of the power amplifier, but also supplies part of the necessary cathode bias voltage for that tube. The rest of the bias for the power amplifier is supplied by a 75-ohm ½-watt resistor. To prevent hum and degeneration a 100-mf, 10-volt electrolytic by-pass condenser is connected across resistor and 3A8 filament.

Another important point to remember is that the pentode end of the 3A8 filament must be the end which is connected to the chassis. This permits operation of the pentode section at zero bias while the triode section grid is negative with respect to its filament by the amount of the drop across the pentode filament (1.4 volts). This is sufficient to provide the approximate cut-off bias required for operation as a plate detector and saves a resistor and condenser otherwise needed.

The rest of the circuit is fairly conventional. The filtering provided by the two 40-μf condensers and the 500-ohm resistor, is so good that no hum was noted even on the 25-cycle current available when the author made a side trip to Canada.

Contrary to expectations the 3A8 has

given no trouble. A notable tendency for the internal cathode connection of the 117L7 rectifier to burn up because of the high peak current drawn by the condenser input filter is corrected by placing a 30-ohm, ½-watt resistor in series with the tube.

The .01-μf condenser across the line proved particularly necessary in certain locations. It assures uniform operation independent of the way the line cord is plugged in. To avoid the shocks always possible with a.c.-d.c. operation take care to so house the set that accidental contact with the chassis is prevented. A good quality .00025-μf mica condenser in the aerial circuit is advisable in case the antenna becomes grounded accidentally. Of course no ground should be used on any a.c.-d.c. set.

Considerable ingenuity is needed to

compress the set into the smallest possible volume. The parts obtainable by the author in Honolulu were not of the true miniature variety.

Coils L1 and L2 are midget broadcast antenna coils and r.f. transformers respectively, and C1-C2 is a two-gang 365-μf midget variable. The volume con-

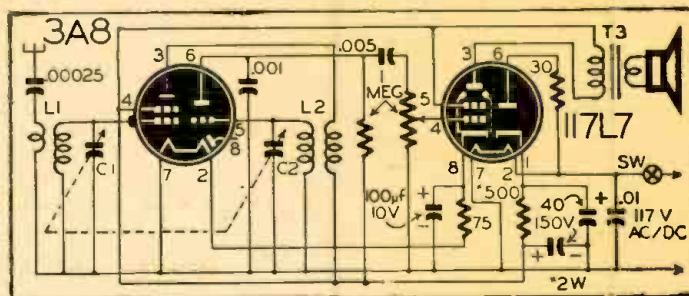

trol is a midget potentiometer. Most of the rest of the parts are of standard size.

Even so it was possible to mount the set and speaker on a plated steel chassis measuring only 5½x3¼x1½ inches. If miniature parts can be obtained and (Continued on page 65)

COMPENSATOR FOR A.C. METERS

By P. HEMARDINQUER

THE most common equipment for measuring weak alternating currents and voltages such as those produced in the audio section of a radio is the so-called rectifier-type meter. It is composed of a meter rectifier of the copper-oxide or the newer high-frequency selenium type, and a microammeter or milliammeter. The greater number of measurements are of voltage, therefore a series resistor or resistors are a necessary part of the apparatus.

Many instruments use the same D'Arsonval milliammeter or microammeter in conjunction with a number of series resistors and shunts to make a large number of different measurements. It is generally impossible to make the same scale read direct and alternating volts, as the rectifier-type meter measures the average current through the meter, and what is required is the effective current, which is slightly over 10 percent higher. Thus d.c. readings on a rectifier-type a.c. meter are about 10 percent too high, as the meter is calibrated to compensate for the rectified a.c. Conversely, if a meter is calibrated to read correct on d.c. its a.c. measurements will be too low.

This difficulty can be avoided at the expense of adding complication to the

meter, by using a separate set of series resistors for a.c. voltage measurements. Their values are approximately 90 percent of those for the corresponding d.c. ranges. Another difficulty still exists—the resistance of the converter is greater for low current intensities than for high. Some meters use a special scale for a.c. for this reason.

A French constructor has discovered a method of solving the latter problem so the a.c. and d.c. scales coincide exactly. The method is adapted to use with European galvanometers of fairly high internal resistance, and will work well with most microammeters. For low resistance milliammeters, a series resistor of 200 to 400 ohms may be attached directly to the meter.

The method is one of compensation. A second rectifier is used as a variable (Continued on page 45)

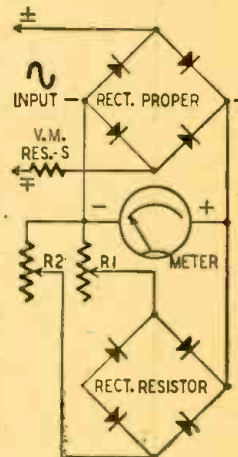

*Ex-Chief Instructor, fire control radar, AAFPOA Ground Electronics School.

Transatlantic News

From our European Correspondent, Major Ralph Hallows



DR. LEE DEFOREST hardly could have foreseen when he invented the grid-

controlled thermionic tube what diverse uses man would find for it in a few brief years. That thought was engendered by some of the amazingly ingenious apparatus displayed at the recent exhibition staged in London by the Physical Society. Architects want to know all about the varying strains in the structures of great buildings. The tube gives all the answers! The tube-maintained vibrations of a stretched wire are used to modulate a small radio transmitter. The wire is so arranged that its tension, and therefore its vibration frequency, is controlled by the particular strain which is being investigated. The transmitter thus sends out an accurate account of what is taking place. More remarkable still were the calculating machines of all sorts and kinds. Flip-flop circuits are made to count the pulses reaching them; time intervals are measured by counting cycles or by capacitor discharge; potentiometer networks add or multiply. In other machines the electronic tube solves four simultaneous equations or effects without turning a hair over such complicated mathematical operations as a Fourier transformation. One can hardly help wondering whether the students and the research workers of tomorrow will require any mathematical ability: one turn of a knob and a machine will do all the work for them. But, then, I suppose people had much the same kind of thoughts when Newton produced his calculus and Napier his logarithms!

Co-axial links

The 120-mile co-axial cable linking London with Birmingham and designed to feed our second television transmitter is now being laid; but the latest news is that the Birmingham station will not be operating this year because of delays due to the recent coal crisis. The authorities have practically decided that the links between our television transmitters must be of the co-axial cable type and not of the radio-relay type. The most important reasons are two in number. First there is the interference caused by reflections from, low-flying planes, which I mentioned a month or

two ago; this might be serious if radio-relay links were used. Second, we adopted (most unfortunately, as it has since turned out) vertical polarization for our vision transmissions when they were started in 1936. Since the government has given a guarantee to those who have purchased television receiving equipment and to those who contemplate doing so that their gear will be able to receive the 405-line transmissions for some years to come, we can't now make a change to horizontal polarization for these transmissions. This is a pity, for vertically polarized transmissions are much more prone to interference from man-made static (especially that due to automobile ignition systems) than those with horizontal polarization. Hence we cannot use vision relay stations for radio links as well.

Television a la Russe

From Russia comes a claim that one of the Soviet's gifted inventors has perfected a television system for use with the ordinary telephone. You don't just hear your correspondent; you see him (or her)! Young folk at the romantic age will no doubt be enthusiastic. You call up the Only Girl and there she is before your enraptured eyes. (Let such ardent youngsters bear in mind that a call to the same girl made a year or two later to explain that they are kept late at the office may not be too easy to put over successfully if she can see the caller and note his reactions to her requests for particulars.) One hopes that the new invention includes a switch enabling the recipient of the call to remain invisible at will. If it does not, some embarrassing situations may arise,

and I foresee removal from our homes of many of the extension telephones which are now so convenient.

Radio-wave velocity

For a long time we have accepted the round figure of 300,000,000, or 3×10^8 meters a second as the velocity of all electromagnetic waves. One frequently reads in radio textbooks that this velocity is fixed and unvarying, no matter what conditions may be. Some years ago A. A. Michelson determined the precise velocity of light waves as 2.99774×10^8 meters a second, with a possible maximum error of $\pm 11,000$ meters per second. The coming of radar and the call for minute precision in the measurement of the travel times of v.h.f. radio waves led to fresh investigations and the discovery that there might be slight variations in the velocity of electromagnetic waves, depending on the wave length and the medium traversed. After some years of laboratory work a new determination of the velocity in a vacuum of centimeter radio waves has been made by Dr. L. Essen, of the British National Physical Laboratory. This works out at 2.99793×10^8 meters per second, with a possible error of not more than 9,000 meters per second. The figure generally accepted during the war for radar waves in air was 2.9982×10^8 meters per second. It is worth-while to note that the velocity of radio waves through air is slightly less than that in free space or through a vacuum. Readers of a mathematical turn of mind may amuse themselves with the following problem: Taking the true velocity of radar waves in air as 0.005% less than that deter-

(Continued on page 70)

THERMISTOR BOLOMETERS



It has been known for some time that the resistance of metals drops with temperature until at absolute zero (-273°C) the resistance actually vanishes. Experiments carried on at a few degrees above this limiting temperature have shown that a current of electricity continues to flow for some time without apparent decay.

More recently it has been discovered that certain semiconductors or thermistors have a very abrupt resistance vs. temperature curve. Below the critical point the thermistor is *superconductive* because of its very low resistance.

When a thermistor is operated near its critical temperature, it is susceptible to very tiny variations in temperature, in some cases as small as 0.000001 degree. Therefore it is possible to measure heat from distant stars, to detect the temperature difference between an engine and the other parts of a plane which is beyond visibility, or even to detect the presence of a human being at a distance of about a quarter of a mile.

The development of thermistor bolometers* was completed just too late for use in the war. However, their extreme sensitivity will find wide application in science and industry within the next few years.

*Bell Telephone Laboratories.

WORLD-WIDE STATION LIST

Edited by **ELMER R. FULLER**

FROM Bill Duggan of Goshen, N. Y., a report has been received regarding the recent sun spots as he viewed them from a spot near Calcutta, Bengal, India. He states that on the 6th of April at noon (local time) three large sun spots could be seen. Bill says that reception on the 20-meter ham band from Chile and Cuba was very strong, and that other frequencies varied during the day. Bill is in the Navy and his reports are few and far between, but very useful when they are received. CKNC, CKCX, and CKCS were received very well in western India during March. In April VQ4?? in Nairobi, Kenya was heard as was "Radio Singapore" and Australia on 15.32, 15.20, and 11.77 megacycles.

Charles Sutton of Toledo, Ohio, reports hearing a new Trinidad station testing 0600 to 0620 and 1900 to 2015 hours EST, using the call VP4RD. Charley also says he has been hearing PMA in Bandoeng, Java, at 1115 to 1132 on 19.350 megacycles. OTC in Leopoldville is heard well on 17.770 mc during late afternoon and Berne, Switzerland, from 2200 to 2230 on 15.315, 11.865, and 9.535 megacycles. VUD7 in Delhi, India, is on 15.160 mc 2240, with the news in English. SVR in Athens is heard calling WLL and WQV at 1900 hours on 14.420 mc. Santa Cruz, Canary Islands, is heard at 1700 to 1800 hours on 7.560 mc. SDB2 is very good on 10.780 mc from 2000 to 2100 hours EST.

Other reports this month include Jo-



The 2-color wall card awarded to shortwave listeners who send regular station reports.

seph R. Rich, a newcomer to our ranks from the Bronx, New York; Edward T. Lambert (address unknown, please advise); U. S. Department of State, and William A. Moore of Waynesboro, Pennsylvania.

Moore of Pennsylvania reports hearing VLG6 in Melbourne on 15.240 mc; ZIK2 in British Honduras on 10.600 mc; ETA in Ethiopia on 15.070 mc; and

CR7AU in Mozambique on 4.920 mc.

Conditions have been fair during the past few weeks, but your editor has been unable to pull in anything very good due to the lack of an antenna. Expect to have a new one up soon, and also expect to be on 2 meters. If any of you hear us give us a call. Best of luck, and lots of fb dx.

All schedules Eastern Standard Time.

Freq.	Station	Location and Schedule	Freq.	Station	Location and Schedule	Freq.	Station	Location and Schedule
2.390		QUARRY HEIGHTS, CANAL ZONE; 0530 to 0700; 1000 to 2305.	4.780	HJAB	BARRANQUILLA, COLOMBIA; 1700 to 2255.	5.840	PZH5	PARAMARIBO, SURINAME; 1800 to 2045.
2.500	WWV	WASHINGTON, D. C.; U. S. Bureau of Standards, 1900 to 0900.	4.790		BANDOENG, NETHERLAND INDIES; 0730 to 0900.	5.870	HRN	TAGUCIGALPA, HONDURAS; 0800 to 1000; 1300 to 1500; 1800 to 2300.
3.075		TOKYO, JAPAN; 0400 to 0900.	4.810	YVIRL	MARACAIBO, VENEZUELA; 0530 to 2230.	5.880	ZRK	CAPETOWN, SOUTH AFRICA; 2345 to 0130; 1030 to 1600.
3.310	YVIRD	TRUJILLO, VENEZUELA; 1700 to 2130.	4.810	HJBB	CUCUTA, COLOMBIA; 1700 to 2200.	5.890		MOSCOW, U.S.S.R.; 0800 to 1645.
3.340	VUD3	DELHI, INDIA; 1200 to 1245.	4.820	XEJG	GUADALAJARA, MEXICO; 2200 to 2400.	5.890	OAX4Z	LIMA, PERU; 1630 to 2330.
3.370	YVIRT	MARACAIBO, VENEZUELA; 1730 to 2230.	4.830	YV2RN	CALI, COLOMBIA; 1900 to 2300.	5.910	OZX4V	LIMA, PERU; 1800 to 2400.
3.380	YV5RY	CARACAS, VENEZUELA; 0930 to 2230.	4.840	YVIRZ	SAN CHRISTOBAL, VENEZUELA; 1100 to 2130.	5.950	HH2S	PORT-AU-PRINCE, HAITI; 0600 to 0815; 1100 to 1300; 1730 to 2130.
3.390	YV4RK	MARACAY, VENEZUELA; 1800 to 2230.	4.850	HJCA	BOGOTA, COLOMBIA; 1900 to 2200.	5.970	HVJ	MOSCOW, U.S.S.R.; 1700 to 2000.
3.390		COLOMBO, CEYLON; 0600 to 1200.	4.860	PRC5	BELEM, BRAZIL; 0600 to 1100; 1530 to 2000.	5.970	VONH	VATICAN CITY; 0900 to 0930; 1000 to 1100; 1300 to 1330.
3.400	YV5RW	CARACAS, VENEZUELA; 0530 to 2230.	4.880	HJFH	ARMENIA, COLOMBIA; 0600 to 2200.	5.980	LRSI	ST. JOHNS, NEWFOUNDLAND; 0900 to 1400; 1500 to 2200.
3.420	YV2RC	MERIDA, VENEZUELA; 1800 to 2130.	4.890	HJCH	BOGOTA, COLOMBIA; 1900 to 2200.	5.980		BUENOS AIRES, ARGENTINA; 1800 to 2300.
3.440	YVIRU	MARACAIBO, VENEZUELA; 1900 to 2130.	4.920	CR7BO	LOURENCO MARQUES, MOZAMBIQUE; 1230 to 1500; Sundays, 1000 to 1400.	5.980		ANDORRA; 0500 to 1900.
3.460	YV4RP	VALENCIA, VENEZUELA; 1730 to 2130.	4.920	YV5RN	CARACAS, VENEZUELA; 0600 to 2230.	5.990	FG8AH	POINTE-A-PITRE, GUADELOUPE; 1700 to 1900.
3.480	YV4RQ	PUERTA CABALLO, VENEZUELA; 1700 to 2130.	4.920	HJAP	CARTAGENA, COLOMBIA; 0600 to 1300; 1700 to 2200.	6.000	ZFY	GEORGETOWN, BRITISH GUIANA; 0545 to 0745; 0945 to 1145; 1415 to 1945.
3.490	YV3RS	BARQUISIMETO, VENEZUELA; 1630 to 2130.	4.940	HJCW	BOGOTA, COLOMBIA; 0645 to 1115; 1600 to 2315.	6.000	CFCX	MONTREAL, CANADA; 0700 to 2315.
3.500	YV5RX	CARACAS, VENEZUELA; 0930 to 1400; 1530 to 2230.	4.950	VQ7LO	NAIROBI, KENYA; 1100 to 1400.	6.000	HP5K	COLON, PANAMA; 0700 to 1300; 1900 to 2300.
3.510	YV6RC	BARQUISIMETO, VENEZUELA; 1800 to 2130.	4.950	HJCQ	BOGOTA, COLOMBIA; 1000 to 1400; 1700 to 2300.	6.010	ZRH	JOHANNESBURG, SOUTH AFRICA; 2345 to 0130; 0900 to 1100.
3.530	YV5RS	CARACAS, VENEZUELA; 0530 to 2230.	4.960	HJAE	CARTAGENA, COLOMBIA; 1600 to 2230.	6.010	CJCX	SYDNEY, NOVA SCOTIA; 0530 to 2200.
3.910	ZQP	LUSAKA, SOUTHERN RHODESIA; 2230 to 1300.	4.970	YV5RM	CARACAS, VENEZUELA; 0530 to 2230.	6.020	HJCX	BOGOTA, COLOMBIA; 0700 to 0800; 1400 to 2315.
3.930	HC5EH	CIUDAD CUENCA, ECUADOR; 1800 to 2230.	4.990	YV3RN	BARQUISIMETO, VENEZUELA; 1630 to 2230.	6.020	XEUW	VERA CRUZ, MEXICO; 0700 to 0100.
4.040		PONTA DEL GADA, AZORES; 1700 to 1900.	5.000	WWV	WASHINGTON, D. C.; U. S. Bureau of Standards; frequency, time and musical pitch; continuously day and night.	6.020	FZI	BRAZZAVILLE, FRENCH EQUATORIAL AFRICA; 1600 to 1845; 0900 to 0130.
4.100	HCJB	QUITO, ECUADOR; 1800 to 2230.	5.300	DTYC	MUNICH, GERMANY; 0900 to 0930.	6.030	PCJ	HUIZEN, NETHERLANDS; 1400 to 1430; 1745 to 1815; 2000 to 2200.
4.700	ZQI	KINGSTON, JAMAICA; 1630 to 1830.	5.530	DAXIB	PIURA, PERU; 1800 to 2330.	6.030	CFYP	MOSCOW, U.S.S.R.; schedule unknown.
4.750	YVIRV	MARACAIBO, VENEZUELA; 0530 to 2130.	5.810		MOSCOW, U.S.S.R.; schedule unknown.	6.030	HP5B	CALGARY, CANADA; 0730 to 0100.
4.770	YVIRY	CORO, VENEZUELA; 1600 to 2130.						PANAMA CITY, PANAMA; 1800 to 2300.
4.780		SINGAPORE, MALAYA; 1730 to 2230; 2330 to 0130.						
4.780	YV4RO	VALENCIA, VENEZUELA; 1630 to 2130.						

(Continued on page 59)

New

RADIO-ELECTRONIC DEVICES

SWEEP GENERATOR

Kay Electric Company
East Orange, N. J.

The Mega-Sweep Jr. is designed for use in servicing and testing FM and television equipment and features wide frequency coverage. It provides a frequency sweep up to 30 megacycles over the frequency spectrum of 400 kilocycles to 500 megacycles. When necessary, the output frequency may be increased to 1,000 megacycles. Thus sweeps are furnished all through the color television frequency bands. Testing of video, i.f., and r.f. amplifiers is possible because the octaves of frequency sweep show almost the entire video pass-band at once, except for the lowest frequency end.



The output frequency is measured with a precision microwave wave-meter, calibrated up to 900 megacycles, which covers the entire range without switching or complicated calibrations.

Power supply is self-contained, operating on 117 volts, 60 cycles. The entire unit is encased in a crackle-finished steel cabinet and weighs 20 pounds. Dimensions are 16 x 8 x 8 inches.—RADIO-CRAFT

AM/FM GENERATOR

McMurdo Silver Corp.
Hartford, Conn.

The Model 906 AM/FM signal generator employs an 8-range rotary turret-type oscillator to cover the range of 90 kc through 170 mc on fundamental frequency output. All 8 ranges are directly calibrated to ± 1 percent accuracy upon the 10:1 vernier-driven main dial. Amplitude modulation at 400 cycles, variable from zero to nearly 100 percent, is provided. Frequency modulation output is available at any frequency between 90 kc and 210 mc by switching into operation a 40 mc fixed-frequency oscillator which beats with the variable-frequency oscillator to produce any desired carrier frequency possible to the combination of the two oscillators. Sweep rate is 60 cycles, with frequency sweep (total swing, or 2 X deviation) variable from zero to over 500 kc.



The output attenuator system, like the oscillators, is multiply shielded within the over-all shield provided by the steel cabinet, to reduce stray radiations to a minimum. Dimensions: 12 3/8 inches long, 7 3/8 inches high and 5 1/4 inches deep.—RADIO-CRAFT

ULTRASONIC TESTER

General Electric Co.
Schenectady, N. Y.

This new ultrasonic materials tester is designed to indicate the presence of voids, cracks, porosity, laminations, poor bonds, and other internal flaws

in metals, plastics, and ceramics and to indicate changes of viscosity, compressibility, and density of liquids, when these significantly alter the velocity or attenuation of ultrasonic transmission.

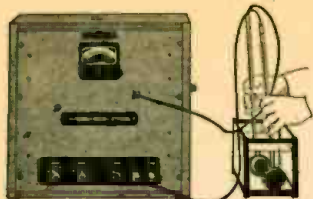

A beam of ultrasonic waves is sent through the specimen being tested. Changes in the amount of energy transmitted indicate the presence and extent of flaws. The tester is portable and self-contained.

The instrument consists of a wide-band ultrasonic transmitting-receiving system having a high-frequency generator, a crystal transducer for producing ultrasonic vibrations, a medium such as water to transmit these vibrations, a second crystal transducer to convert the received energy into electrical signals, and an indicator supplying information for materials inspection or analysis.—RADIO-CRAFT

TWO-STATION INTERCOM

Radio Corp. of America
Camden, N. J.

The new two-station intercom system is designed with amplifier and speaker station in separate units, permitting location of the amplifier at any out-of-the-way point and reducing speaker size to a minimum. Speaker stations are housed in streamlined black plastic cabinets with satin-chrome speaker grills.

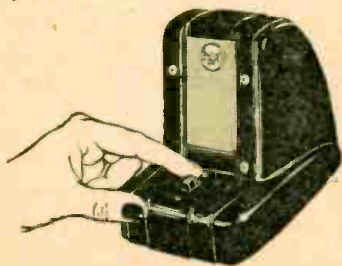

Especially designed for such two-station use as communication between executive and secretary or doctor and receptionist, the system consists of two speaker stations, separate amplifier, and 100 feet of interconnecting wire. It is easily installed and plugs into any 110-volt a.c. or d.c. outlet. If desired, additional stations up to five can be connected to the amplifier.—RADIO-CRAFT

SOLDERING TOOL

Sound Equipment Corp. of California
Glendale, Calif.

The cordless Kwikheat is a pencil-type, cordless soldering iron designed for intricate work.

The instrument is placed in operation by simply screwing the heater-receptacle into any size Kwikheat electric soldering iron and plugging-in. The forged tellurium copper alloy tip holds approximately 680 degrees tempera-



ture for nearly one minute and reheats in approximately 20 seconds by reinserting into the heater-receptacle, similar to the manner of using a desk pen set. The heater-receptacle and the normal soldering tip are quickly interchangeable.—RADIO-CRAFT

AIRCRAFT RADIO

General Electric Co.
Syracuse, N. Y.

The new two-way radio, Type AS-1C is designed for use in private planes. Operating directly from a twelve-volt power system, the AS-1C weighs twelve and one-half pounds and is 9 1/2 inches long. The receiver has frequency ranges of 200-420 kc and 500-1500 kc, includes automatic volume control, a directional loop antenna arrangement, and a voice filter.

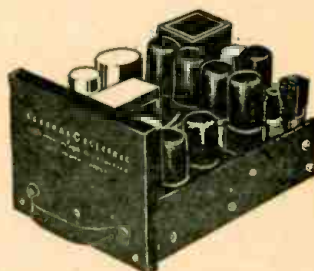
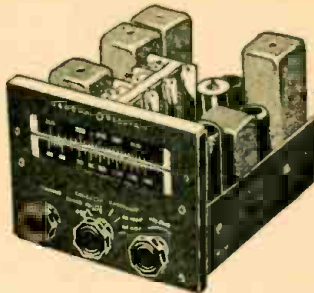

The transmitter operates at 3105 kc, crystal controlled, and furnishes 12 watts carrier output. For normal use the radio requires headphones and microphone though, in some installations where the cabin noise level is low, the use of a loudspeaker is recommended.—RADIO-CRAFT

RECORDING HEAD

Techno-Craft Products Co.
New York, N. Y.

Lightweight construction and simplified operational features make the Techno-Craft recorder suitable for high-quality home recorders and semi-professional work. Other features are: Cutting needle angle adjustment, single lever for engaging feed screw and lowering cutting head, and positive drive and gear which cannot be clogged by chips. The recording mechanisms are adaptable to any height recording turntable. A thumb-

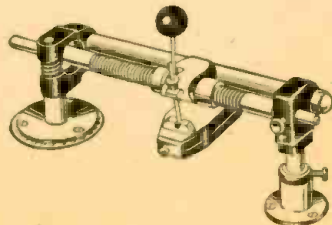

screw allows for accurate adjustment of cutting depth. Its cutting pitch is 110 lines per inch, outside-in. The two models available permit recordings up to 16 inches diameter. The heaviest model weighs less than 3 pounds. Other features are: vertical adjustment for accurate alignment with any turntable, and complete removability from mounting flange.

Four types of static cutting heads are furnished at present: X-26, X-29A, M-41-8, and M-41-500.—RADIO-CRAFT

FREQUENCY COMPUTER

American Hydromath Company
New York, N. Y.

The new Calculaide frequency computer correlates, in one setting, the natural frequency and wavelength of a circuit comprising a coil and condenser with the physical dimensions of the coil and the capacity of the condenser with all answers given at a single setting of the instrument.

The computer's range covers frequencies from 400 kilocycles to 150 megacycles and wavelengths from 2 to 600 meters. It handles condensers between 2 and 1000 microfarads. Inductance values can be determined from 0.1 to 1500 microhenrys. The device performs calculations with coils of 1/4 inch to 5 1/2 inches diameter, 1/4 inch to 10 inches length, 2 to 150 turns per inch, of No. 10 to No. 35 wire—RADIO-CRAFT

VACUUM-TUBE VOLTMETER

General Radio Co.
Cambridge, Mass.

The type 1800-A vacuum-tube voltmeter supersedes the Type 726-A and offers new features and improvements. It is smaller, lighter, and easier to use, it reads d.c. as well as a.c. voltages, and can be used at much higher frequencies.

The range of a.c. voltage measurement is 0.1 to 150 volts. Frequency correction curves for both resonance and transit-time effects for frequencies up to 500 megacycles are supplied. Where absolute voltage readings are not required, the instrument can be used as a voltage indicator up to 2,500 megacycles. A single zero setting serves for all ranges. D.c. voltages between 0.01 volt and 150 volts can be measured.—RADIO-CRAFT



ILLUMINATED METERS

Marion Electrical Instrument Co.
Manchester, N. H.

The new Marion line of illuminated instruments comprises a departure from the conventional method of inserting a pilot lamp in an opening in the rear of the meter. This new design, applicable to all 2 1/2- and 3 1/2-inch round and square instruments, the 4 1/2-inch rectangular instrument, and the Model 525 tuning meter (but not to Hermetics), utilizes a transparent lucite cavity which seals the opening against dust, while at the same time controlling the size of the bulbs and safeguarding the movement.—RADIO-CRAFT

OUR POLICY We do not advertise any unit which is not available for immediate shipment from stock. • Less flowery adjectives, more detailed specifications. • All units are sold subject to one year guarantee except when components are damaged

through misuse. • We do not solicit orders for any unit that does not meet our requirements for accuracy and honest value. Any item purchased from us is sold with the understanding that it may be returned for full refund after a 10 day trial.

20% DEPOSIT REQUIRED ON ALL C.O.D. ORDERS



The New Model 60-T TUBE and SET TESTER

A COMPLETE TUBE TESTER

Tests all tubes including the new post-war miniature octals such as the 12AT6, 12AU6, 35W4, 50B5, 117Z3, etc. • Tests by the well-established emission method for tube quality, directly read on the scale of the meter • Tests shorts and leakages up to 3 Megohms in all tubes • Tests leakages and shorts of any one element against all elements in all tubes • Tests both plates in rectifiers • Tests individual sections such as diodes, triodes, pentodes, etc., in multi-purpose tubes.

Model 60-T operates on 90-120 Volts 60 Cycles A.C. Housed in sloping leatherette covered cabinet. Comes complete with test leads, tube charts and detailed operating instructions.

\$49⁸⁵
NET PRICE

ACOMPLETETESTER

- 6 D.C. Voltage Ranges: 0 to 7.5/15/75/150/750/1,500 Volts
- 6 A.C. Voltage Ranges: 0 to 15/30/150/300/1,500/3,000 Volts
- 4 D.C. Current Ranges: 0 to 1.5/15/150 Ma. 0 to 1.5 Amps.
- Low Resistance Range: 0 to 2,000 Ohms (1st division is 1/10th of an ohm.)
- 2 Medium Resistance Ranges: 0 to 20,000/200,000 Ohms
- High Resistance Range: 0 to 20 Meg-ohms
- 3 Decibel Ranges: -10 to +38 +10 to +38 +30 to +58 D.B.

EXTRA: WE CAN NOW SUPPLY THE MODEL 60 HOUSED IN A BEAUTIFUL HAND-RUBBED OAK CABINET, COMPLETE WITH PORTABLE COVER MAKING IT SUITABLE FOR EITHER BENCH OR OUTSIDE USE, ONLY \$2.75 ADDITIONAL. SPECIFY MODEL 60-C.

The New Model B-45 SIGNAL GENERATOR

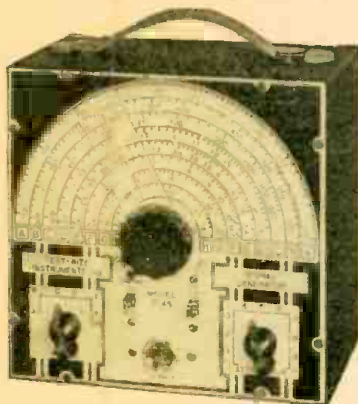

Self-modulated — provides a highly stable signal. RF frequencies from 150 Kc. to 12.5 Mc. on Fundamentals and from 11 Mc. to 50 Mc. on Harmonics. Modulation is accomplished by grid-blocking action—equally effective for alignment of amplitude and frequency modulation as well as for television receivers. Self-contained batteries. All calibrations are etched on the front panel permitting DIRECT READING.

Model B-45 uses a beautifully processed dual-

tone front panel. Comes housed in a heavy-gauge crystalline steel cabinet complete with shielded test lead, self-contained batteries and instructions.

\$27⁷⁵

COMPLETE, READY TO OPERATE

The New Model 670 SUPER METER

A Combination Volt-Ohm-milliammeter plus Capacity Reactance, Inductance and Decibel Measurements

D.C. VOLTS: 0 to 7.5/15/75/150/750/1500/7500.

A.C. VOLTS: 0 to 15/30/150/300/1500 3000 Volts.

OUTPUT VOLTS: 0 to 15/30/150 300/1500 3000.

D.C. CURRENT: 0 to 1.5/15/150 Ma.; 0 to 1.5 Amps.

RESISTANCE: 0 to 500/100,000 ohms 0 to 10 Megohms.

CAPACITY: .001 to .2 Mfd., .1 to 4 Mfd. (Quality test for electrolytics).

REACTANCE: 700 to 27,000 Ohms; 13,000 Ohms to 3 Meg-ohms.

INDUCTANCE: 1.75 to 70 Henries; 35 to 8,000 Henries.

DECIBELS: -10 to +18, +10 to +38, +30 to +58.

The Model 670 comes housed in a rugged, crackle-finished steel cabinet complete with test leads and operating instructions. Size 5 1/2" x 7 1/2" x 3".



\$28⁴⁰

The New Model CA-11 SIGNAL TRACER

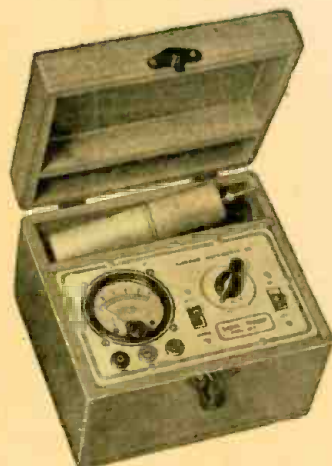

Simple to operate . . . because signal intensity readings are indicated *directly on the meter!*

★ SIMPLE TO OPERATE —only 1 connecting cable —NO TUNING CONTROLS.

★ HIGHLY SENSITIVE—uses an improved Vacuum Tube Voltmeter circuit.

★ Tube and resistor-capacity network are built into the Detector Probe.

★ COMPLETELY PORTABLE — weighs 5 lbs. and measures 5"x6"x7".

★ Comparative Signal Intensity readings are indicated directly on the

meter as the Detector Probe is moved to follow the Signal from Antenna to Speaker.

★ Provision is made for insertion of phones. The Model CA-11 comes housed in a beautiful hand-rubbed wooden cabinet. Complete with Probe, test leads and instructions.

\$18⁷⁵

The New Model 450 TUBE TESTER

Speedy operation — assured by newly designed rotary selector switch which replaces the usual snap, toggle, or lever action switches.

SPECIFICATIONS

- Tests all tubes up to 117 volts. • Tests shorts and leakages up to 3 Megohms in all tubes. • Tests both plates in rectifiers. • New type line voltage adjuster. • Tests individual sections such as diodes, triodes, pentodes, etc., in multi-purpose tubes. • Noise Test—detects microphonic tubes or noise due to faulty elements and loose internal connections. • Uses a 4 1/2" square rugged meter. • Works on 90 to 125 volts 60 cycles A.C.

EXTRA SERVICE—May be used as an extremely sensitive condenser Leakage Checker. A relaxation type oscillator incorporated in this model will detect leakages even when the frequency is one per minute.



\$39⁵⁰

GENERAL ELECTRONIC DISTRIBUTING CO. DEPT. RC-8, 98 PARK PLACE, NEW YORK 7, N. Y.

TRY THIS ONE

CHANGER RACK

This method of rigging up a record changer rack is inexpensive. Fasten two 12-inch shelf brackets to one end of the work bench so that the top will be about $\frac{3}{4}$ inch below the top of the bench. A piece of $\frac{3}{4}$ x 2-inch lumber is cut to the width of the bench and screwed to the

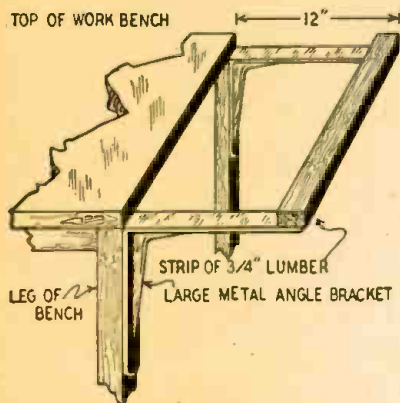

top of the brackets. This provides space for mounting two changers of the average size, with sufficient height for servicing from underneath.

GEORGE MURAKAMI,
Sacramento, Calif.

SIMPLE TRACER

I have never seen described in any radio magazine a tracer which is as simple as the one which has been giving me satisfaction for some months.

Both the 0.006 capacitor and the IN34 crystal are in the handle of the probe. A high-quality pair of headphones must be used. With my Western Electric 3,500-ohm phones, it has enough sensitivity to pick up a good signal from my signal generator. When it is connected between an outdoor antenna and ground, all the local stations can be heard at once.

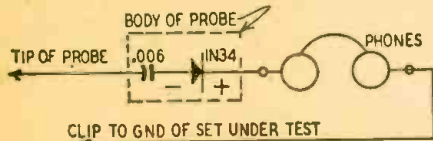

I have used this signal tracer on a number of difficult jobs, and find it as satisfactory as my expensive one, with the one exception that it does not tune the signal.

O. B. MILLER,
Albuquerque, N. M.

(RADIO-CRAFT makes no apology for printing this circuit, though many old-timers will hasten to point out that they used it in their youth, before signal tracers were invented. While it cannot be expected to be as efficient as tracers using tubes, it can be reasonably sensitive if high-quality components are used, and deserves printing again for the benefit of the younger generation.—*Editor*)

ANTENNA INSTALLATION

When installing antennas in a home, I have often found it necessary to run a lead-in across a room under a carpet. This is a simple matter if flexible indoor type antenna wire is secured to the handle of a screw driver, which can be worked along under the carpet.

AMOS BABB,
Chicago, Ill.

OHMMETER KINK

Accidental shorting of the test prods of my ohmmeter, when not in use, placed a constant drain on the batteries, making frequent replacements necessary. I fastened a piece of Artgum eraser in one end of the compartment where the prods are stored. When not in use, the tips of the prods are forced into the eraser. This prevents the tips from shorting and also keeps them clean, which gives me better contacts.

THOMAS HIGGINS,
Ottawa, Canada.

LINE BOOSTER

I have found that low line voltage is frequently responsible for poor radio performance in some areas. To boost the voltage, insert an 8- to 10-volt toy transformer, connected as an autotransformer as shown.

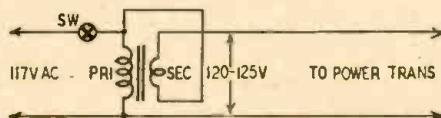

This can also be applied to a.c.-d.c. receivers if the heater supply is taken from the line ahead of the transformer as a precaution in case the voltage rises to normal.

KEITH W. MOHLER,
Gary, Ind.

(It may be necessary to reverse the connections to the secondary winding to get a step-up instead of a step-down in output voltage. A reversing switch will make it boost or drop the voltage—a useful feature in some districts.—*Editor*)

PA SPEAKER MATCHING

Most amplifiers and public address systems are designed for use with either one or two speakers and are equipped with socket-type outlets and a switch or terminal board for changing impedances. When the operator has several systems, it is unlikely that they will have the same type of output terminals. This makes it necessary to have a number of plugs and odd-sized connectors when changing speakers from one system to another.

A solution is to use the same plugs and sockets in all amplifiers and add an additional socket to eliminate switching. Color-coded sockets will reduce errors and guesswork when making quick in-

stallations. Most of the labor in making the change is in drilling the hole for the extra socket.

Use the small pins of a brown 4-prong socket for an 8-ohm speaker, and connect the small pins of two black 4-prong sockets in series across the 16-ohm tap for higher efficiency. The usual procedure is to connect two 8-ohm speakers in parallel across a 4-ohm tap. There is a loss in overcoming wire resistance and in poor contacts between sockets and plugs. A 1-ohm resistance may exist in two 100-foot speaker cables and will absorb one-quarter of the power delivered into the 4-ohm load but will have negligible effect on a 16-ohm circuit.

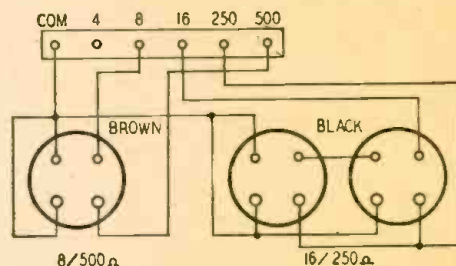

If line transformers are desired, the large pins on the brown socket are connected across the 500-ohm taps and the pins on the black sockets paralleled across the 250-ohm tap.

These changes need not disturb the existing terminal strip which may be used for other impedances and for patching. The 3-socket system provides for rapid and foolproof installation.

HART WEBBER,
Red Bank, N. J.

SOCKET TOOL

One-hole tube sockets require a round hole with a projecting lip to keep the socket from turning. Although adapter mounting rings are available, extra work is required to drill two bolt holes and the finished job does not have a professional appearance. After trying several ways of making a round hole with a projecting lip, a simple solution was found. The hole is drilled just under $1 \frac{5}{32}$ inches in diameter to get a tight fit. A piece of $\frac{1}{4}$ -inch drill rod was ground down to give a flat point equal in width to one of the slots in the socket and about $1/16$ inch thick. This rod is used as a punch. It is placed at the edge of the socket hole (with chassis on an anvil) and the chassis metal upset in the direction of the socket hole. One good hammer blow will cause enough metal to be formed into a satisfactory lip to keep the socket from turning. The finished job, with socket in place, cannot be distinguished from the standard factory-punched operation.

FLOYD FELLOWS,
Flushing, N. Y.



ESSE Specials!

BEAM ROTATING MOTOR

SHOWN ON LEFT

By simple conversion these motors cannot be excelled for rotating your beam antenna. Operates from 20-35 V. AC or DC. Motor: 1/3 H. P. reversible with 7,000:1 gear reduction ratio. Speed approximately 1 revolution per minute. Has heavy thrust bearing, permitting heavy weights to be borne directly. Motors are removed from electric propellers of surplus aircraft.

Price, each, including conversion data **\$14.95**

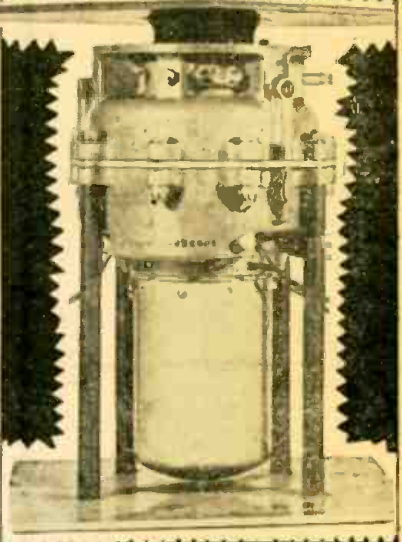

BEAM ROTATING MOTOR - CONVERTED

Motor Shown on Right Converted and Ready for Use

Price **\$37.50**

TRANSFORMER, specially built for operation of the above mentioned motors: 110-120 V. 60-cycle input, 28-32 V. output.

Price **\$4.95**

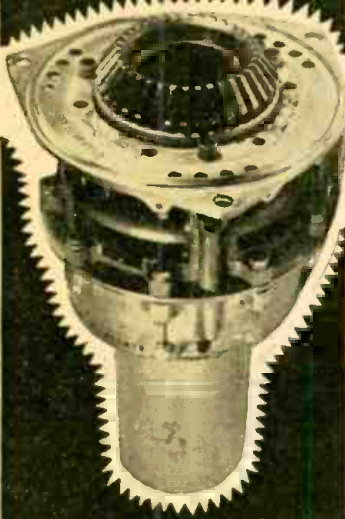

BC 348 RECEIVERS

Used but reconditioned and guaranteed.

Price **\$47.95**

ARC 4 TRANSMITTER AND RECEIVER

For operation VHF frequencies in range of 140-152 mc. Four channel crystal controlled, manufactured by Western Electric — 12 or 24 V. operation.

Price **\$29.75**

SCR 522

Complete with dynamotor and remote control.

Price **\$27.50**

BC-654 A

Complete with tubes, less power supply.

Price **\$12.50**

ART-13 COLLINS AUTO-TUNE TRANSMITTER

Price **\$88.50**

BC-733 D LOCALIZER RECEIVER

Price **\$8.50**

R-89/ARN-5A GLIDE PATH RECEIVER

Price **\$8.50**

BC-433 ADF RECEIVER

Less dynamotor, loop, etc. **\$31.50**

ARB AIRCRAFT RADIO RECEIVER

Complete with dynamotor and remote controls.

Price **\$29.75**

SELSYN INDICATORS Selsyn Indicators

For use with beam rotators for indication of direction of beam. Operate from 15-24 V. 60-cycle AC supply. Complete with Selsyn Transmitter and wiring instructions.

Price, large model

\$11.50

5-INCH DIAMETER

Price, small model

\$9.50

3-INCH DIAMETER



TERMS:
CASH
with
ORDER

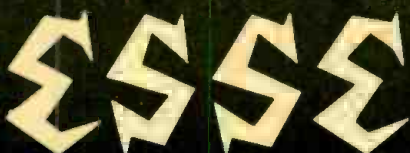

Radio Company

130 W. New York St. • Indianapolis 4, Ind.

RADIO-ELECTRONIC CIRCUITS

TONE CONTROL SYSTEMS

Tone controls and equalizers are of 4 fundamental types, giving either top cut, top lift, bass cut, or bass lift. The British magazine *Electronic Engineering* has prepared a very neat reference sheet—reproduced here—to show how each of these may be incorporated in a circuit.

Fig. 1 shows the fundamental curves. The effect depends on the position of point B, which is varied by choosing condenser and resistor values in the circuit. If B is set at 30 cycles, for example, curve ABC represents bass cut; if B is set in the upper part of the audio-frequency spectrum the curve indicates top lift.

Frequency response is controlled by the respective values of R2 and C1 (Figs. 2 and 3). Thus if the reactance

of C1 is equal to R2 at 200 cycles, the basses are boosted. The same combination in Fig. 3 cuts the basses. The way

RADIO-CRAFT presents this month, instead of its usual radio-electronic circuits, a selection of the best of those which have appeared in recent technical literature. If readers approve of the new system it will be adopted. Let us hear what you think.

these fundamental circuits are applied to an amplifier is shown in Figs. 4 and 5. Practical component values for these two figures appear in the table.

Fig. 6 is a combination of Figs. 2 and 3. With the values given, both top and bass lift are obtained, the signal being

up 12 decibels at 30 and at 10,000 cycles. By suitable selection of values, top and bass cut could be obtained instead of lift.

Tone control can be used in negative feedback circuits. Effects will be the reverse of those obtained in "straight" circuits. A network which would normally produce the response curve of AC in Fig. 1 would have a curve like DBE if connected in a negative feedback circuit. Fig. 8 is an example of the application of Fig. 2 to a negative feedback circuit, and Fig. 7 a similar adaption of Fig. 3. If the reactance of C1 is made equal to R2 at a high audio frequency, the circuit of Fig. 7 gives top cut. Bass lift can be obtained by matching these constants at a low audio frequency. Fig. 8 is a practical realization of Fig. 2 in a feedback circuit. Values can be taken from Fig. 4, noting that the effects are reversed.

To make any of these controls variable, a variable resistor is placed across C1 in circuits derived from Fig. 2 and in series with C1 in those derived from Fig. 3. Its maximum value should be at least 5 times the reactance of C1 at the lowest frequency to be handled by the circuit. Fig. 9 is an example of such a circuit.

Details of Frequency Response	Fig. No.	Component Values
Bass lift, beginning at 300 cycles, rising 12 db at 50 cycles.	4	RL, 50,000 ohms; Cc, 0.01 μ f; R, 250,000 ohms; R2, 50,000 ohms; C1, 0.015 μ f; Rg1, 1 megohm.
Top cut, beginning at 2,000 cycles, falling 12 db at 10,000 cycles	4	RL, 50,000 ohms; Cc, 0.01 μ f; R1, 250,000 ohms; R2 omitted; C1, 0.002 μ f; Rg1, 1 megohm.
Bass cut, beginning at 300 cycles, falling 11 db at 50 cycles.	5	RL, 50,000 ohms; Cc omitted; C1, 0.001 μ f; R2 omitted; R1, 1 megohm.
Top lift, beginning at 2,000 cycles, rising 12 db at 10,000 cycles.	5	RL, 50,000 ohms; Cc, 0.02 μ f; C1, 100 μ f; R2, 500,000 ohms; R1, 100,000 ohms.

A NEW OSCILLATOR

A circuit which offers several advantages over the transitron has been developed by Dr. A. H. Taylor of the Naval Research Laboratory, Washington, D. C. Maintaining the 1-coil feature of the transitron oscillator, it permits operating the elements at or near normal voltage, as opposed to the 10 volts or less normally applied to the plate in the usual transitron.

As described in *Electronics* magazine, the circuit is based on the use of a pentagrid tube such as the 6A8. The feedback condenser, which in the normal transitron is placed between screen grid and suppressor, is connected in this circuit between G2 (or plate) and G4.

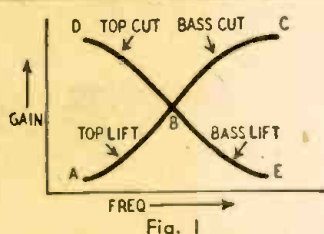

Fig. 1

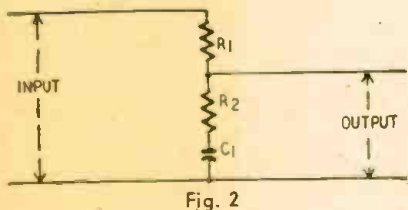

Fig. 2

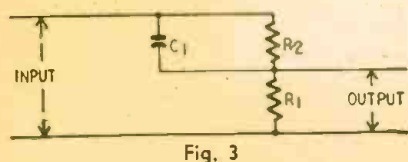

Fig. 3

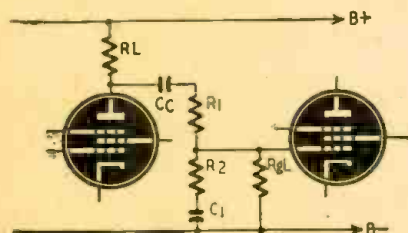

Fig. 4

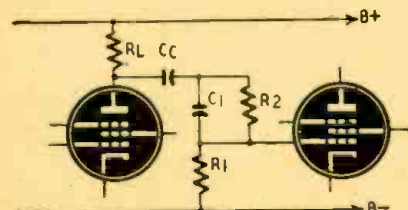

Fig. 5

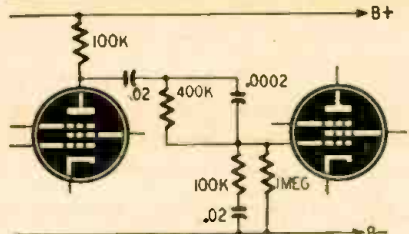

Fig. 6

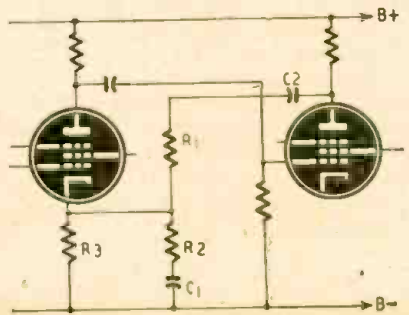

Fig. 7

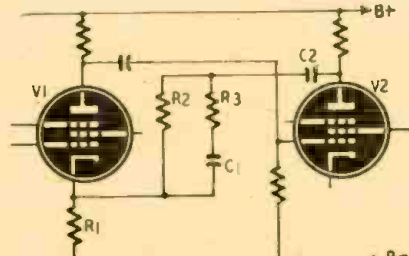

Fig. 8

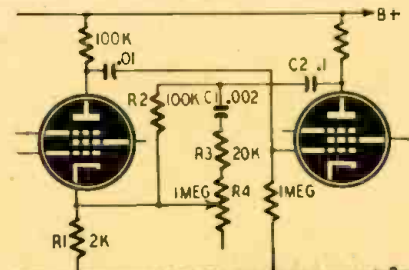
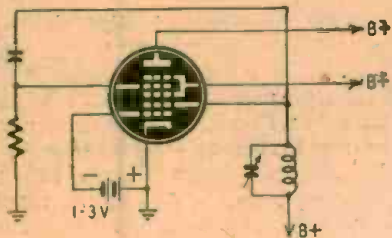

Fig. 9

Thus if the voltage is suddenly raised on G2, the voltage rise appears on G4, increasing current to plate and decreasing current in the G2 circuit. Thus an increase in voltage in the G2 circuit results in a decrease in voltage, and the reverse. This is a condition of negative resistance, therefore oscillations can be produced in a coil-condenser combination in the G2 circuit. (G1, G2, refer to oscillator grid, anode grid, etc., as per standard converter tube nomenclature.)



Besides the advantage of working at normal voltages, which should give more power output in many applications, Dr. Hoyt believes longer or at least more predictable tube life should result. The circuit also has excellent stability and almost complete independence of any injected signal, no matter how strong or how close in frequency to that of self-oscillation.

The circuit has a number of other applications. For example, a signal can be injected at G4 and equal and opposite outputs taken from plate and G2, a slight negative bias being placed on G1 and variable resistors being put in the plate and G2 circuits to permit balancing the output.

COMPENSATOR FOR A.C. METERS

(Continued from page 37)

resistor bridged across the meter, as shown in the figure. A pair of resistors (R1, R2) which are variable from zero to approximately 10 times the internal resistance of the meter serve to adjust the unit. For greater ease of adjustment, the rectifier-resistor should be identical in type with the rectifier proper.

At low current intensities, the resistance of the rectifier cells is very high—running up to as much as 25,000 ohms for .01 milliampere and 4,000 ohms for 0.1 ampere in one rectifier measured. The effect of the shunted rectifier on the meter is therefore negligible.

As the current increases, the internal resistance of the rectifier cells decreases, increasing the effect on the meter reading. It is thus possible to compensate rigorously for the non-linearity of the rectifiers, obtaining a linear scale.

LCETI

TRANSVISION

4 GOOD DOLLARS-AND-SENSE REASONS WHY
The TRANSVISION TELEVISION KIT
IS THE CHOICE OF DISTRIBUTORS, DEALERS
AND THOUSANDS OF USERS!

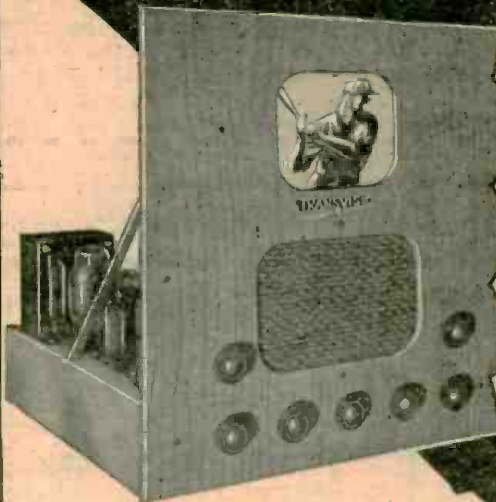

BEAUTIFUL CABINET: Transvision offers a beautifully-styled cabinet exclusively designed for their kit. Made of selected grain wood with attractive hand-rubbed walnut finish. An accessory kit is included for use in mounting the assembled Transvision set into the cabinet. Overall size 17 1/4" deep: 19 1/4" wide: 15 3/4" high. **NET \$29.95**

NATIONAL ADVERTISING in leading publications, plus dealer displays, plus local service agencies back up the Transvision policy—to offer the tops in television from every angle: quality, value, service, dependability, and enjoyable reception.



IMMEDIATE DELIVERY: The extensive engineering and manufacturing facilities of Transvision facilitate prompt shipment of all orders.

BIGGEST VALUE
 LEADING "BUY" IN THE FIELD

TOP QUALITY
 IN EVERY PART

NEW SYNC. CIRCUIT
 GIVES STABLE PICTURE

BACKED BY EXTENSIVE
NATIONAL
ADVERTISING

● **BIGGEST VALUE:** When assembled the Transvision Kit becomes a television receiver worth more than twice its cost. The quality of performance has been acclaimed superior to other available sets by over 10,000 satisfied users.

The kit is **COMPLETE** with sight and high fidelity sound reproduction. Nothing more to buy. No technical knowledge required for assembly. Our complete easy-to-follow instruction sheet gives you all the knowledge you need. No test equipment needed. All difficult assemblies such as the R.F. Unit, I.F. Transformers, are factory wired and pre-tuned... **NET \$159.50** (fair traded).

● **TOP QUALITY PARTS:** You get a brilliant 7-inch Lectrovision Picture Tube, all other 17 tubes; pre-tuned R.F. Unit, tuned I.F. Transformers, 6" speaker, and all other necessary parts including a finished front panel, solder, hook-up wire, a **NEW SPECIALLY DESIGNED FOLDED DI-POLE ANTENNA** with 60 feet of low-loss lead in cable. The total value of all these parts would come to over \$300.00 list.

● The pre-tuned R.F. UNIT mentioned above is the heart of the television set. It is completely wired, pre-tuned, and tested by Transvision. Includes 6C4 oscillator and 6AC7 converter tubes. Designed for high conversion gain and 6mc bandwidth. Nothing for you to do but install.



● **NEW SYNC. CIRCUIT** achieves stable picture, sharp focus. Engineered by Transvision, it gives a maximum of picture stability even in areas of low signal strength or high noise levels. Clear enjoyable reception assured.

See your local distributor, or for further information write to:

TRANSVISION Inc., Dept. R.C. 385 North Ave., New Rochelle, N. Y.

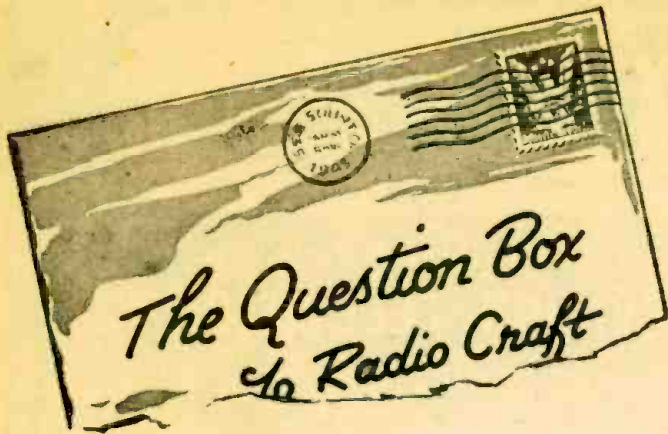

Question Box queries will be answered by mail and those of general interest will be printed in the magazine. A fee of 50c will be charged for simple questions requiring no schematics. Write for estimate on questions that may require diagrams or considerable research.

RECEIVER CONVERSION

? I have an Emerson Model CT275 battery receiver which I would like to convert to operate from a 117-volt a.c. line and using 6-volt tubes. Kindly print a diagram of the converted set.—J.J.O., Perth Amboy, N. J.

ment instead of the present batteries. The same output transformer may be used with a slight mismatch, but better quality may be had by obtaining one with a heavy core that will match the 6V6 power amplifier.

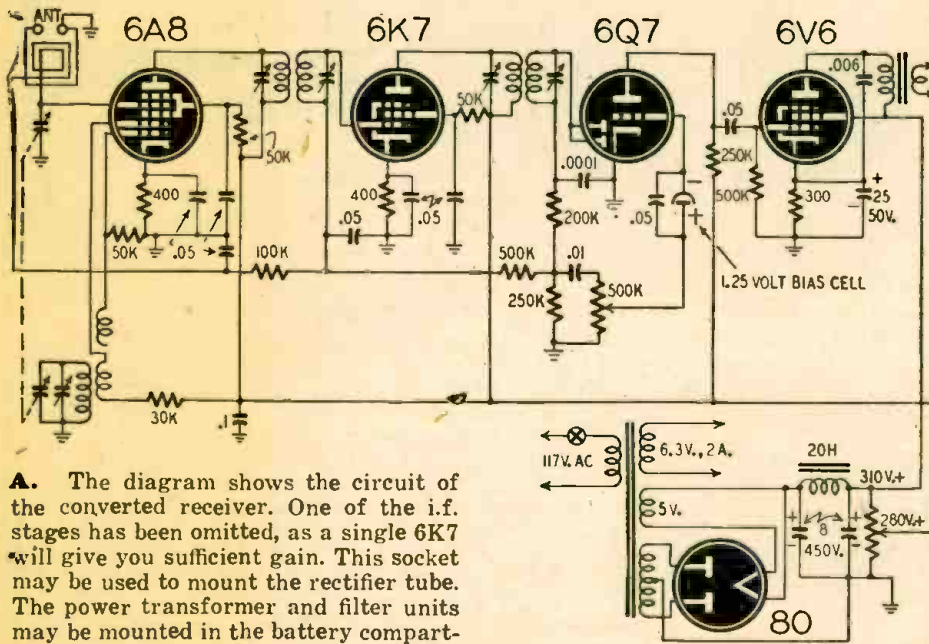

A. The diagram shows the circuit of the converted receiver. One of the i.f. stages has been omitted, as a single 6K7 will give you sufficient gain. This socket may be used to mount the rectifier tube. The power transformer and filter units may be mounted in the battery compart-

ered by shunting the secondary of the a.f. transformer with a small condenser.

The low i.f. range is covered with a 115-kc i.f. transformer and the 225- to 560-kc range with a 456-kc i.f. transformer. All other coils are wound on 1/2-inch forms with enamel wire. The coils for the broadcast band are scramble-wound with 110 turns of No. 30 on L1 and 75 turns of No. 28 for L2. The coils are separated by 1/8 inch. For 1500 kc to 3.5 mc, L1 has 65 turns of No. 30 close-wound and spaced 1/8 inch from L2 which has 45 turns of No. 28. For 3.0 to 9.5 mc, L1 has 20 turns of No. 28 double-spaced. L2 is separated from L1 by 1/8 inch and has 16 turns of No. 28 close-wound. The 9 to 25-mc range is covered by using 5 turns of No. 24 double-spaced for L1 and 10 turns of No. 28 close-wound for L2. The windings are separated by 1/16 inch.

The a.f. signal may be used for signal tracing in a.f. amplifiers and receivers.

Functions of switch: Position 1—Off, Position 2—Unmodulated r.f., Position 3—Modulated r.f., Position 4—a.f. only.

REMOTE CONTROL UNITS

? Please print diagrams of a transmitter and receiver to be used for control of model boats. These units are to be operated on the 450- to 460-mc band. A relay in the plate circuit of the receiver is to operate a small relay-controlled escapement.—D.H., Baytown, Texas.

A. Transmitter and receiver diagrams are shown. The r.f. output of the 955 is modulated with a 456-kc signal which may be keyed to give the control pulses. The coupling tap between the b.f.o. coil and the plate of the 955 may be varied for proper modulation percentage.

(Continued on page 75)

SIGNAL GENERATOR

? I would like to have a diagram of a battery-powered signal generator covering from 100 kc to 25 mc with plug-in coils. Can miniature tubes be

used?—C.R., Tabernash, Colo.

A. This signal generator is battery-operated and covers the required range. Internal modulation is provided. The modulating tone may be low-

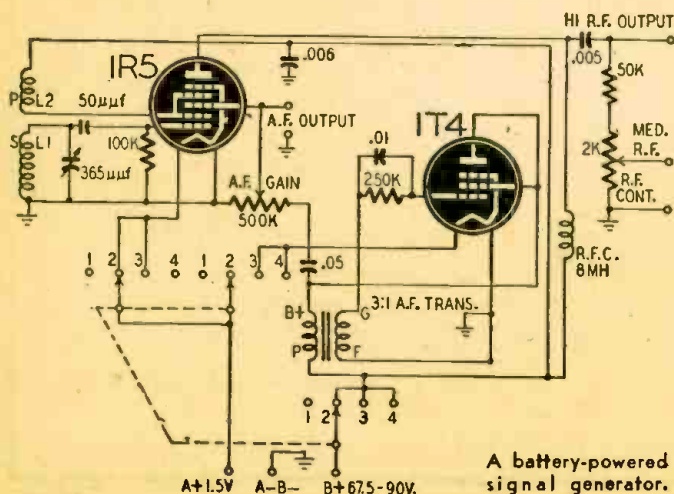

A battery-powered signal generator.

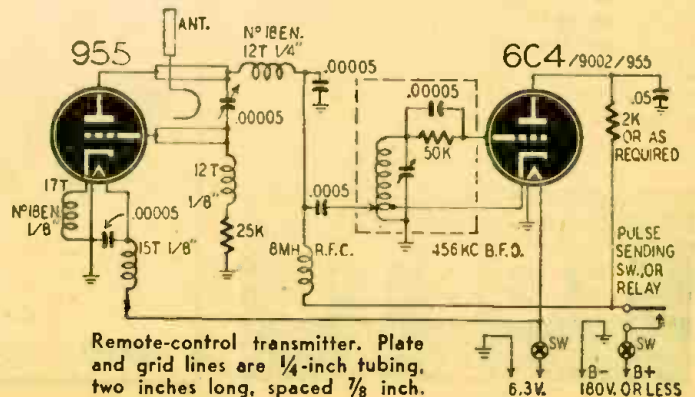

Remote-control transmitter. Plate and grid lines are 1/4-inch tubing, two inches long, spaced 1/8 inch.

MILLER EFFECT FM
(Continued from page 35)

ulating voltage (with resultant change in input capacitance) depends of course upon the L/C ratio of the frequency-determining tank circuit.

One method used by the author to produce FM by the Miller effect was to suppressor-modulate an RK-23 in an electron-coupled oscillator circuit. The plate voltage was 300 volts, the screen voltage, 150 volts, taken from two conventional VR-150 tubes in series across the power supply. The suppressor was biased 12 volts negative with a C-battery with taps every 3 volts from 3 to 24 volts. The tank circuit used a Bud 40-

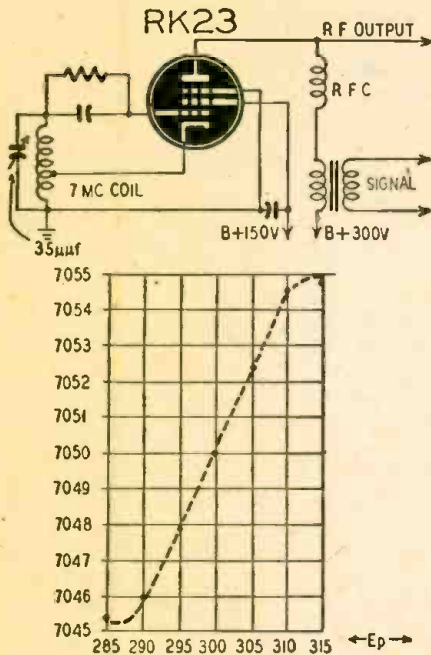

Fig. 4—Effect of varying the plate voltage.

meter coil (OCL-40) with approximately 35- μ f tuning capacity. Fig. 2 shows the operating characteristics of this particular transmitter. It can be seen that the linear portion of the curve would just accommodate a variation of about 12 volts on the suppressor grid (6 volts either side of -12 volts bias), which would swing the operating frequency about 6 kc (3 kc either side of 7050 kc). If operation were desired on the 10-meter band, 2 doublers would be necessary; and the total frequency deviation would be 24 kc at the output of the second doubler. Thus the amount of audio voltage necessary to realize a 15-kc deviation from this oscillator is very slight, actually only a few volts. Increasing the suppressor voltage (decreasing bias) causes a decrease in resonant frequency, which is similar to the screen voltage-frequency curve (Fig. 3) of an electron-coupled oscillator⁵. Increasing the plate voltage causes an increase in resonant frequency (Fig. 4). These figures show the relative effectiveness of slight changes in suppressor grid voltage in varying frequency.

⁵ Dow: "A Recent Development in Vacuum Tube Oscillator Circuits," IRE Proceedings, December, 1931.

YOU'VE BEEN WAITING FOR IT— HERE IT IS!



PLASTIC PLIERS

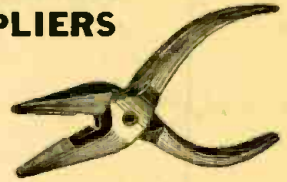

- Shockproof
- Weight 1 1/2 oz.
- Non-Magnetic
- Heat Resistance 300 Degrees
- 6000 Volt Breakdown
- Will Not Short
- Comfortable Grip

BONDED

Gives you this new practical condenser kit in a handsome slide drawer metal cabinet. Contains 25 electrolytic condensers used in 99% of your service work.



CABINET SPECIFICATIONS

- Size 9"x9"x2"
- Sliding Drawer
- Removable Partitions
- Baked Enamel Finish
- Heavy Gauge Metal
- Will not Bend or Sag
- Can Be Stacked

1 Metal Cabinet \$4.00
1 Pair of Plastic Pliers ... 1.50
Total \$5.50

HERE IS WHAT YOU GET

2	25	MFD 50 W.V...	\$ 1.80
2	16	MFD 150 W.V...	1.80
2	24	MFD 150 W.V...	1.90
1	30	MFD 150 W.V...	1.00
1	40	MFD 150 W.V...	1.10
6	8	MFD 450 W.V...	5.70
3	16	MFD 450 W.V...	4.05
3	20x20	MFD 150 W.V...	3.90
1	40x40	MFD 150 W.V...	1.70
1	50x30	MFD 150 W.V...	1.70
1	8x8	MFD 450 W.V...	1.70
*1	8	MFD 475 W.V...	1.80
*1	8x8	MFD 475 W.V...	2.70

*Inverted screw Can Mounting

Total List Price \$30.85

Your Cost Complete Kit #100 **\$14.97**

Bonded is Going Places

SOME BONDED FEATURES

Come Along...

- Etched Foil—Withstands all Climatic Conditions
- Compact and Durable
- Seamless Drawn Aluminum Cans
- Long Life Under Continuous Hard Service
- No Better Condenser at any Price

FOR SALE
By Leading Radio Parts Distributors

IF YOUR LOCAL JOBBER CANNOT SUPPLY YOU.

SEND ORDER AND CHECK DIRECT TO US—
WITH NAME OF YOUR JOBBER



BONDED ELECTRONICS CO.

161 WASHINGTON ST., NEW YORK 6, N. Y.

I'll Train You Quickly—at Home—in Your Spare Time—to Make More Money in the Fastest Growing Industry in the World!



WHO SAID IT COSTS A LOT OF MONEY TO LEARN RADIO ELECTRONICS?



Ghirardi's Famous RADIO PHYSICS COURSE costs you only \$5 complete... and it IS complete! 36 BIG COURSES IN ONE!

FOR BEGINNERS!

No previous experience needed

Send coupon today! Examine Ghirardi's big, 972-page RADIO PHYSICS COURSE for five full days. See how this one giant book at ONLY \$5 can give you complete, basic training to pave the way for a brilliant future in Television, Radio, Frequency Modulation, Facsimile, Broadcasting, Communication, Servicing, Industrial Electronics, etc. Prove to yourself that training doesn't need to be expensive to be really good!

9 OUT OF 10 RADIO MEN CAN'T BE WRONG!

Actually, this famous book has given more people their start in Radio-Electronics than any other book or course ever published. On an actual survey among 817 men already in radio, 724 of them—9 OUT OF 10—answered that Ghirardi's RADIO PHYSICS COURSE is their choice as the finest, easiest to understand training on the market—and far better than any other book or course they have ever seen!



LEARN FAST! LEARN RIGHT!

... as fast as you can read! You'll be pleasantly surprised how RADIO PHYSICS COURSE helps you master subjects that other courses make seem very complicated. Starting with Basic Electricity—over 300 pages—it takes you through the entire Radio-Electronics field. Everything is made crystal clear. Nothing is omitted or condensed. You buy it for only \$5 complete—ON OUR MONEY-BACK GUARANTEE. You progress as fast as spare reading time permits. Many students have completed it in a few weeks. 972 pages, 508 illustrations and 856 self-test review questions make study doubly easy. Rush coupon. You cannot lose!

MAIL ORDER—Rush Coupon

Dept. RC-87, Murray Hill Books, Inc., 232 Madison Ave., New York 16, N. Y.
 Enclosed find \$5 (\$5.50 foreign) for Ghirardi's 972-page RADIO PHYSICS COURSE book; or send C.O.D. for \$5 plus postage (no foreign C.O.D.'s). In either event, if not satisfied, it is understood I may return book in 5 days for complete refund of my money.

Name
 Address
 City & Zone State

MONEY-BACK GUARANTEE

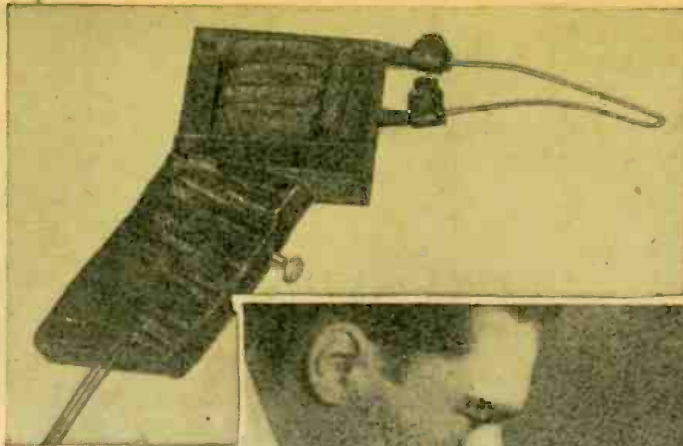

Appearance of the gun. Several modifications might be made to suit it to the taste of the raw materials.



The author services a receiver with the aid of this soldering gun.

A SOLDERING GUN

By RAL COLLINS

THE quick-heating soldering pistols now on the market are desired by many hams and radio experimenters, but the cost is too high to warrant the purchase of one by persons who do not use an iron a great deal. These are such handy little gadgets that I undertook the construction of one from parts out of the ever-present junk box. The first one I constructed is still giving good service after many hours of operation.

Any small power transformer having a good primary will furnish the basic element for this gun. The case is unbolted and the laminations carefully disassembled. All windings except the primary are removed (the best way to remove the high-voltage winding is to saw through it with a hacksaw). The number of turns in the 5-volt rectifier winding is counted during the unwinding. This will serve as a guide to the number of turns required by the new high current winding, which will be approximately one-tenth of the number counted, for the new winding is to deliver about 0.5 volt to an open circuit. A little experimenting with more or fewer turns might be necessary to arrive at this potential.

When the primary winding is free, the determined number of turns of No. 4 stranded synthetic covered

wire is bent around it, secured, and the transformer structure is reassembled as shown in the diagram. If sufficient space is not available in the core structure to accommodate the covered No. 4, the insulation is removed, and a single layer of friction-tape insulation substituted.

A handle with a convenient switch is attached with 2 strap-iron or brass brackets, and the primary connected to a line-cord through the switch and brought out through the bottom of the handle. A 7-inch piece of No. 12 solid bare copper wire is bent in a V and connected to the high-current leads with 2 screw-type connectors to provide a simple and quick means of changing tips. Dip the point of the V in soldering paste, push the switch, and in less than 10 seconds the point can be tinned and ready for work.

The tool constructed in this way is not intended for assembly-line use, but will in all probability serve to great advantage in the home workshop.

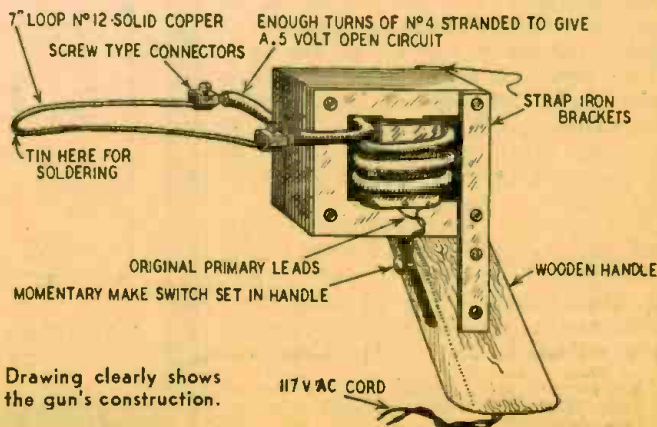

Drawing clearly shows the gun's construction.

JOBBER AND DEALERS WHO SELL RADIO-CRAFT

This list is compiled as a convenience to our readers. You will find the latest RADIO-CRAFT displayed on the counters of these dealers. They can also supply you with the radio parts you need in your work.

ALABAMA

Alabama City
Brooks Radio Service
102 South 4th St.
Decatur
Radio & Tel. Sup. Co.
717 Bank St.
Dothan
Hand Wholesale Radio
& Refrig.
707 S. Oates St.
Tuscaloosa
Allen & Jamison Co.

ARIZONA

Phoenix
Radio Specialties
& Appt.
401 W. Jackson

CALIFORNIA

Fresno
Jack C. Arbutklo
1427 Broadway
Hollywood
Hollywood Radio Sup. Inc.
5521 Hollywood Blvd.
Pacific Radio Exchange
1401 Cahoenga Blvd.
Yale Radio Electric Co.
6616 Sunset Blvd.
Long Beach
Fred S. Dean Co.
969 American Ave.
Scott Radio Supply
226 Alamitos Ave.
Los Angeles
General News Agency
326 W. 5th St.
Papel Bros.
2639 E. 4th St.
Radio Tel. Sup. Co.
1509 So. Figueroa St.
Oakland
Electric Supply Co.
149 - 12th St.
Sacramento
E. M. Kemp Co.
1115 R. St.
Sacramento Elec. Sup. Co.
711 Capitol Ave.
San Bernardino
Arrowhead Radio & Television
1216 D St.
San Diego
Electronic Equip. Distr.
1228 2nd Ave.
Western Radio & Elec. Co.
1415 India St.
San Francisco
Associated Radio Dist.
1251 Polson St.
San Francisco Radio
& Supply Co.
1284 Market St.
San Jose
Frank Quement Whole-
sale Radio
156 W. San Francisco St.
Santa Ana
Radio & Tel. Equip. Co.
207 Oak St.
COLORADO
Denver
McGee Radio & Elect. Co.
4330 Broadway
Western Electronic
Lab. Co.
913 18th St.
Grand Junction
Radio & Electronics
Supply Co.
418 South 7th St.
Variety Electric Co.
601 Broad St.

CONNECTICUT

Bridgeport
Coastal Radio Service Co.
1559 Stratford Ave.
R. C. Seell & Co., Inc.
84 Elm St.
L. N. Waldhaus
1132 Norman St.
Hartford
R. G. Seell & Co.
317 Asylum St.
New Britain
United Radio Supply
53 E. Main St.

DELAWARE

Wilmington
Radio Electric Service Co.
4th and Tatnall Sts.

DISTRICT OF COLUMBIA

Washington
Capitol Radio
Wholesalers
2120 14 St. N.W.
Intercommunications Co.
2027 Nichols Ave. S.E.
Kenyon Radio Supply Co.
2214 14th St. N.W.
Sun Radio
938 N.W. F St.

FLORIDA

Jacksonville
Radio Parts Co.
712 Main St.
Thurow Distr. Inc.
15-17 E. Church St.
Miami
Thurow Distr. Inc.
420 S.W. 8th Ave.
Waldner Radio &
Appliance Co.
1809 N.E. 2nd Ave.
Orlando
Thurow Distr. Inc.
131 South Court St.
Pensacola
Grice Radio & Elec
Supply
26 E. Garden St.
St. Petersburg
Welch Radio Supply
408 9th St. So.
Tallahassee
Thurow Distr. Inc.
213 E. Tennessee St.
Tampa
Thurow Distr. Inc.
134 S. Tampa St.
West Palm Beach
Thurow Distr. Inc.
308-310 So. Dilvo Ave.

GEORGIA

Augusta
Prestwood Electronics Co.
727-29 Reynolds St.
Columbus
Radio Sales & Svc. Co.
1326 First Ave.
Macon
Guy White Radio
654 Mulberry St.

ILLINOIS

Benton
Lamply Radio Co.
802 N. McLeansboro St.
Danville
Allen Electric Co. Radio
Supply
109 N. Hazel St.
Decatur
York Radio Distr. Co.
801-805 N. Broadway St.
Chicago
Allied Radio Corp.
833 W. Jackson Blvd.
American Parts Inc.
610 W. Randolph St.
Belmont Radio Supply
1921 Belmont Ave.

Concord
Radio Corp.
901 W. Jackson Blvd.
Electronic Distributors
620 W. Randolph
Lake Radio Sales Co.
615 W. Randolph St.
Radio Shack
630 W. Randolph St.
Radolek Co.
601 W. Randolph St.
Seuh Radio Parts
1253 Loyola Ave.

Rockford
H. & H. Electronic Supply
510 Kishwaukee St.
Mid-West Associates
506 Walnut St.

Springfield
Harold Bruce
303 E. Monroe
Wilson Supply Co.
108 W. Jefferson St.

INDIANA

Anderson
Seybert's Radio Supply
19th E. 12th St.
Evansville
Castrup's Radio Sup.
1014 W. Franklin St.
Montoux Auto & Machine Co.
517 Locust St.

Fort Wayne
Wall Distr. Co.
241 Pearl St.
Gary
Cosmopolitan Radio Co.
524 Washington St.

Hammond
Stanton Radio Supply
521 State St.
Indianapolis
Rodefeld Co.
614 N. Capitol

Richmond
Rinehart Inc.
511-513 Main St.
South Bend
Commercial Sound
& Radio Co.
534 E. Colfax Ave.

Terre Haute
Terre Haute Radio
501 Ohio St.

IOWA

Council Bluffs
World Radio Labs
Des Moines
Radio Trade Supply
1224 Grand Ave.
Dubuque
Boe Distributing Co.
498 N. Grandview
Sioux City
Dukes Radio Co.
114 W. 4th St.
Power City Radio Co.
513 7th St.
Sioux City Radio
& Appliance Co.
313 Fifth Street

Waterloo
Farnsworth Radio & Telev.
623 Jefferson
Ray-Mac Radio Supply
324 W. 4th St.

KANSAS

Pittsburgh
Pittsburgh Radio Sup. Co.
103 N. Broadway
Topeka
Acme Radio Supply
516 Quincy St.
Wichita
Interstate Distr. Inc.
1236 E. Douglas
Radio Supply Inc.
1125-27 E. Douglas

KENTUCKY

Lexington
Kentucky Radio Supply Co.
519 Georgetown St.

Louisville
Peerless Electronic
Equip. Co.
912-914 So. Second St.

Newport
Apex Distributing Co.
506 York St.

Owensboro
Central Electronics Supply
203 W. 4th St.

LOUISIANA

Lafayette
Radio-Electronic Sup.
1419-21 Cameron St.

Monroe
Male & McNeil
301 Pine St.

New Orleans
Wm. B. Allen Supply Co.
916-918 W. Claiborne Ave.
Radio Parts Inc.
807 Howard Ave.

Shreveport
Koelemay Sales Co.
327 Market
Radio Supplies Inc.
2408 Line Ave.

MAINE

Bangor
Radio Service Lab.
45 Haymarket Sq.

Portland
Maine Electronic
Supply Corp.
13 Deer St.
Radio Service Lab.
45 A Free St.

MARYLAND

Baltimore
Henry D. Berman Co. Inc.
12 E. Lombard St.
D. & H. Dist. Co.
31 E. Lee St.

Richmond
Kann-Ellert Elec.
9 South Howard St.
Royal Radio
941 Penna. Ave.

Terre Haute
A. R. Spartana Co.
239 N. Gay St.
Wholesale Radio Parts
Co. Inc.
311 W. Baltimore St.

Cumberland
Cumberland Radio
Wholesalers
143 N. Centre St.

MASSACHUSETTS

Boston
Sager Electrical Sup. Co.
201 Congress St.

Lawrence
Hatry & Young of Mass.
Inc.
639 Essex St.

Melrose
Melrose Sales Co.
407 Franklin St.

New Bedford
C. E. Beckman Co.
Commercial St.

Springfield
Springfield Radio Co. Inc.
405 Dwight St.

Springfield Sound Co.
147 Dwight St.

Worcester
Radio Maintenance Supply
19-25 Central St.

MICHIGAN

Ann Arbor
Purchase Radio &
Camera Shop
605 Church St.

Berkley
The J. M. Morel Co.
1949 Woodward Ave.

Detroit
M. N. Duffy & Co.
2040 Grand River Ave.
Electronics Inst. Inc.
21 Henry at Woodward

Hershey Radio
5249 Grand River

Radio Center
5834 W. Warren
Radio Electronic Supply
1112 Warren West
Radio Specialties
456 Charlotte St.
Radio Supply Co.
6724 Michigan Ave.
Radio Supply & Eng. Co.
129 Selden Ave.
Westside Radio Supply
6724 Michigan Ave.

Flint
Radio Tube Mfg Co.
508 Clifford

Highland Park
Hi-Park Distr.
155 LaBelle Ave.

Jackson
Fulton Radio Supply Co.
707 S. Blackstone St.

Lansing
Electric Products Sales Co.
427 E. Michigan Ave.

Muskegon
Industrial Electric
Supply
1839 Peck St.

Saginaw
Drem Distributing Co.
801 E. Genesee Ave.
Radio Parts Co.
234 S. Second St.

MINNESOTA

Duluth
Lew Bonn Co.
228 E. Superior St.
Northwest Radio
109 E. First St.

Minneapolis
Lew Bonn Co.
1211 LaSalle Ave. So.
Northern Radio Lab.
3927 East Lake St.

MISSISSIPPI

Jackson
Cabell Electric Co.
Refrigeration & Air
Conditioning Supplies
116 S. Gallatin

Meriden
Radio Supply Co.

MISSOURI

Cape Girardeau
Suedakum Electronic
Supply Co.
902 S. Sprigg St.

St. Joseph
Acme Radio Supply
110 N. 9th St.

St. Louis
Napper Radio Co.
3117 Washington
Ralph Toler Radio Co.
4855 Easton Ave.

Springfield
Harry Reed Radio &
Supply Co.
833-37 Boonville Ave.

NEBRASKA

Lincoln
Hicks Radio Co.
1422 "O" St.

Omaha
Alco Radio Inc.
4011 Cuming St.
All-State Distr. Co.
2857 Farnum St.
H. C. Noll Co.
226 Harney St.
Omaha Appliance Co.
18th & St. Mary's
Radio Equipment Co.
2820-22 Farnum St.

NEW JERSEY

Atlantic City
Paramount Radio & Elec.
3 S. Providence Ave.
Trenton Electronics
1516 Atlantic Ave.

Bridgeton
Joe's Radio Shop
67-69 S. Pearl

See Other Side For Additional Listings

NEW JERSEY (Cont')**Camden**
National Electric Service Co.
513 Cooper St.**Hackensack**
Trade Radio Service Co.
10 1/2 Morris St.**Jersey City**
Nidisco
713 Newark Ave.**Newark**
Continental Sales Co.
195-197 Central Ave.Lafayette Radio
24 Central Ave.
Variety Elec. Co.
601-603 Broad St.
Passale Nidisco Radio Parts
205 Madison St.**Phillipsburg**
Carl B. Williams Co.
154 South Main St.**Red Bank**
Monmouth Radio Supply
Co.
396 Shrewsbury Ave.**Trenton**
Allen & Hurley
25 South Warren St.**NEW YORK****Albany**
E. E. Taylor Co.
465 Central Ave.**Binghamton**
Broome Dist. Co.
221 Washington St.**Brooklyn**
Electronic Equipment
Co. Inc.
1460 Bushwick Ave.
Green Radio Distr.
482 Sutter Ave.
Hornbeam Distributing Co.
1639 Bedford Ave.**Buffalo**
Buffalo Radio Supply
219 E. Genesee St.
Dymac Inc.
2329-31 Main St.Radio Equipment Corp.
147 GeneseeStandard Electronics
Dist. Co. Inc.
1497-1501 Main St.**Cortland**
C. A. Winchell
37 Central Ave.**Croton-On-Hudson**
WRO Radio Laboratory
6 Hamilton Ave.**Elmira**
Fred C. Harrison Co.
108 W. Church St.**Hempstead**
Standard Parts Corp.
235 Main St.**Jamaica**
Harrison Radio Corp.
172-31 Hillside Ave.
Norman Radio Dist.
94-29 Merrick Rd.
Peerless Radio Dist. Co.
92-32 Merrick Rd.**Jamestown**
Johnson Radio &
Electronic Equip.
48-50 Harrison Ave.**Mount Vernon**
Davis Radio Dist. Co.
66-70 E. 3rd St.**New York City**
Adson Radio
221 Fulton St.
Arrow Radio
82 Cortlandt St.
Beam Radio
165 Noble Ave.
Bonafide Radio & Elec. Co.
89 1/2 Cortlandt St.
Bronx Wholesale Radio
470 E. Fordham Rd.
Blan Radio
64 Day St.
Douglas Radio Supply Co.
128 Greenwich St.
Eagle Radio
84 Cortlandt St.
Electronic Marketers Inc.
120 Greenwich St.
Federated Purchaser Inc.
80 Park Place
Grand Central Radio
124 E. 44th St.
Harrison Radio Corp.
12 W. Broadway
Harvey Radio Co.
105 W. 43rd St.
Highbridge Radio
Television & Appl.
340 Canal St.
Lafayette Radio
100 Sixth Ave.
Leonard Radio Inc.,
69 Cortlandt St.Milo Radio & Electronics
200 Greenwich St.
National Radio Dist.
899 Southern Blvd.
Niagara Radio Supply Corp.
160 Greenwich St.
Newark Electric Co.
212 Fulton St.
Newark Electric Co. Inc.
115 W. 45 St.
North Radio Co., Inc.
172 Washington St.
Powell Radio Supply
142 W. 169th St.
Radionic Equipment Co.
170 Nassau St.
Risco Electronics
22 Warren St.
Sun Radio
122 Duane
Wilco Radio Dist.
383 E. 138th St.**Olean**
Wanamaker & Redstone
413 Third Ave.**Poughkeepsie**
Chief Electronics
104 Main St.**Rochester**
Hunter Electronics
233 East Ave.
Masline Radio &
Electric Equip.
192-196 Clinton Ave. N.
Rochester Radio Sup. Co.
114-118 St. Paul St.**Syracuse**
Broome Dist. Co.
912 Erie Blvd. E.
Stewart W. Smith Inc.
325 E. Water St.
Syracuse Radio Supply
238-40 W. Willow St.**White Plains**
Westchester Electronic
Sup. Co.
333 Mamaroneck Ave.**NORTH CAROLINA****Charlotte**
Henry V. Dick & Co. Inc.
311 E. 5th St.**Goldsboro**
Signal Radio Supply
124 S. Jarvis St.**Raleigh**
Supreme Radio Suppliers
103 W. Hargett St.**Winston-Salem**
Dalton-Hesse Radio Sup. Co.
340 Brookstown Ave.**NORTH DAKOTA****Fargo**
Fargo Radio Service
511-515 Third Ave. N.
Radio Equipment Co.
624 2nd Ave. N.**OHIO****Ashtabula**
Morrison's Radio Supply
331 Centre St.**Akron**
Brighton Sporting
Goods Corp.
110 E. Market St.**Cincinnati**
Herringer Dist. Co.
15th & Vine Sts.
Holub & Hogg
500 Reading Rd.**Cleveland**
Northern Ohio Labs.
2073 W. 85th St.
Radio Surplus Co.
648 Prospect Ave.
Strong, Carlisle &
Hammond Co.
2801 St. Clair Ave.
Winteradio Inc.
1468 W. 25th St.**Columbus**
Electronic Supply Corp.
219 N. 4th St.
Whitehead Radio Co.
120 East Long St.**Warren**
Radio Specialties
136 S. Pine St.**Dayton**
Standard Radio &
Elect. Prod.
135 E. 2nd St.**Kent**
Khadag Radio Labs.
105 W. Erie St.
Ferguson Radio Inc.
14553-51 Madison Ave.**Marion**
Bell Radio Supply
527 N. Main St.**Stuebenville**
D & R Radio Supply
156 S. 3rd St.
Hausfield Radio Supply
230 N. 4th St.**Toledo**
Lifetime Sound Equip. Co.
911-913 Jefferson
Warren Radio Specialties
136 S. Pine Ave.**OKLAHOMA****Lawton**
Reynolds Radio Supply
909 1/2 C Ave.**Oklahoma City**
Electronic Supply Co.
212 N. W. 10th St.
Radio Supply Inc.
724 N. Hudson, Box 597**OREGON****Portland**
Appliance Wholesalers
of Oregon
609 N. W. 14th Ave.
Portland Radio Supply Co.
1300 W. Burnside St.**PENNSYLVANIA****Allentown**
Radio Electric Service Co.
1042 Hamilton St.**Altoona**
Kennedy Radio Supply
1500 Fifth Ave.**Beaver Falls**
Reliable Motor Parts Co.
1700 7th Ave.**Easton**
Radio Electric Service Co.
916 Northampton St.**Erie**
Jordan Electronic Co.
201 W. 4th St.
Warren Radio
12 & State Sts.**Harrisburg**
D. & H. Distributing
Co. Inc.
311 S. Cameron St.**Lancaster**
Eshelman Supply Co.
110 N. Water St.**McKeesport**
Barno Radio Co.
321-6th Ave.**Philadelphia**
A. G. Radio Parts Co.
3515 N. 17th St.
Almo Radio
509 Arch St.**Pittsburgh**
Flanagan Radio Corp.
5251 Market St.
Herbach & Rademan Co.
522 Market St.
M. & H. Sporting Goods Co.
512 Market St.
Radio Electric Service Co.
7th & Arch Sts.
3145 North Broad St.
5133 Market St.
Warner Radio Co.
631 Market St.**Pittsburgh**
Tydings Co.
632 Grant St.**Seranton**
Broome Dist. Co.
26 Lackawanna Ave.
Fred P. Pursell
550 Wyoming Ave.**Sharon**
Helges Bros. Inc.
1344 E. State St.**York**
J.R.S. Distributors
656 W. Market St.**RHODE ISLAND****Providence**
City Hall Hardware
Washington St.
William Dandreta & Co.
Regent Ave.**SOUTH CAROLINA****Charleston**
Radio Laboratories
215 King St.**Greenville**
Arthur Rixon & Son
209 W. Washington**TENNESSEE****Chattanooga**
Curie Radio Supply
825 Cherry St.**Kingsport**
Radio Electric Sup. Co.
210 Cherokee St.**Knoxville**
Bomar Appliance Co. Inc.
520 Western Ave.**Memphis**
Bluff City Dist. Co.
905 Union Ave.McGregor's Inc.
1071 Union Ave.Radio & Electronic
Supply Co.
1002 Jackson Ave.Shobe Inc.
1117 Union Ave.**Nashville**
Frost Electric Inc.
1922 West End Ave.**TEXAS****Amarillo**
Tom Thomas Sound Sales
& Service
Box 1148**Dallas**
All-State Dist. Co.
2405-07 Ross Ave.
Southwest Radio Sup.
1820 N. Harwood**Fort Worth**
Ft. Worth Radio Sup. Co.
1201 Commerce
The Electronic Equip. Co.
301 E. 5th St.
"Scooter's Radio Supply"
5059-11 Commerce St.**Houston**
Crumpacker Dist. Co.
34 N. Hamilton St.
Sterling Radio Prod. Co.
1602 McKinney**Laredo**
Radio & Electronics
Supply Co.
1219 Lincoln St.**Lubbock**
R & R Supply Co. Inc.
706 Main St.**Port Arthur**
Lapham Radio Co.
309 1/2 Proctor St.**San Antonio**
Mission Radio Inc.
814 So. Presa St.**Tyler**
Radio Service Supply Co.
111 University Place**Waco**
The Hargis Co. Inc.
1305 Austin Ave.**UTAH****Ogden**
Ballard & Carter Co.
203 24th St.**Salt Lake City**
O'Laughlin's Radio
Supply Co.
113 E. Broadway
Radio Supply Co.
45 E. 4 South**VIRGINIA****Bristol**
Bristol Radio Supply
64 Commonwealth Ave.**Hopewell**
Harry's Radio Shop
244 E. B'way**Norfolk**
Ashman Distributing Co.
807 Granby St.
Radio Parts Dist. Co.
128 W. Olney Rd.
Radio Supply Co.
711 Granby St.**Richmond**
Johnston Gasser Co.
1402 E. Main St.**Roanoke**
H. C. Baker Sales Co.
19 W. Franklin Rd.
Leonard Electronic
Supply Co.
106 Second St. S.W.**Salem**
Riehle Radio Supply
306 E. Main St.**Staunton**
Southern Electric Corp.
14 E. Johnson St.**WASHINGTON****Bellingham**
Waikus Supply Co.
110 Grand Ave.**Seattle**
Harper-Maggee
960 Republican St.
Western Electronic
Supply Co.
2609 First Ave.**Spokane**
Columbia Electric
& Mfg. Co.
P. O. Box 1441 S.**Tacoma**
C. & G. Radio Sup. Co.
714 St. Helens Ave.
A. T. Stewart Co.
743 Broadway
Wible Radio Supply
909 Tacoma Ave.**WEST VIRGINIA****Clarksburg**
Trenton Radio Co.
791-93 W. Pike St.**East Charleston**
Hicks Radio Supply
10 Virginia St.**Parkersburg**
John A. Cox Radio
Supplies
554 7th St.**Wheeling**
General Distributors
21 10th St.**WISCONSIN****Appleton**
Valley Radio Dist.
518 N. Appleton St.**Chippewa Falls**
Bushland Radio Spec.**Green Bay**
Neslo Electronic Dist.
312 N. Chestnut**Hudson**
J. H. Larson Co.
109 Walnut St.**LaCrosse**
Stark Radio Supply Co.
131 S. 6th St.**Madison**
Satterfield Radio
Supply Inc.
326 W. Gorham St.**Manitowac**
Harris' Radio Company
115 No. 10th St.**Milwaukee**
Acme Radio Supply Corp.
510 W. State St.
Acme Radio Supply
510 W. State St.
Central Radio Parts Co.
1723 West Fond du Lac Ave.
Electro-Pliance Dist. Inc.
2458 W. Lisbon Ave.
Electronic Supply Corp.
436 W. State St.
Taylor Electric Co.
112 N. Broadway**Racine**
Standard Radio Parts Co.
1244 State St.**Sheboygan**
Nitz's
1127 N. 8th St.**WYOMING****Casper**
Golden Power Oil &
Supply Co.
260 S. Center**Cheyenne**
Houge Radio & Supply Co.
2008 Carey Ave.**CANADA****Radio Supply Co. Ltd.**
Grd. Floor McLeod Bldg.
Edmonton, Alberta.**Western Radio Supply Co.**
328-330 King St. E.
Hamilton, Ontario**Delroy Sales Ltd.**
203 Rideau St.
Ottawa, Ont.**Electronic Supply Co.**
(Ottawa Ltd.)
142 Bank St.
Ottawa, Ont.**Electro-Voice Sound
Systems**
141 Dundas St. West
Toronto, Ont.**Hygrade Radio Ltd.**
538 Cambie Ct.
Vancouver, B.C.**Bowman-Anthony Ltd.**
144 Pitt St.
Windsor, Ontario**DEALERS: If you are not receiving RADIO-CRAFT, please ask for our Special Consignment Proposition.**

OSCILLATORS

(Continued from page 32)

tion and feedback results, to sustain oscillations. A shunt feed is used, 26 being an r.f. choke. The r.f. voltage between 3 and 1 of 16 is applied to a small lamp bulb in the phono pickup through 18. The light intensity is controlled by 17. Reducing the resistance of 17 cuts the voltage to the lamp and reduces the phono output; increasing 17 has the opposite effect. A current of about 1800-ke frequency is used to operate the light-beam reproducer. A short circuit in 25 probably would result in burning out 26 or 16. A faulty variable resistance at 17 impairs operation of the light-beam. If the beam flickers appreciably or cuts on and off intermittently

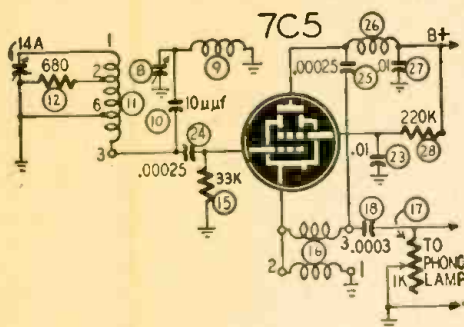

Fig 8—Oscillator of the Philco 42-1008.

as 17 is adjusted, the unit is defective and can be checked with an ohmmeter or by replacing it.

A short in trimmer 8 or coil 9 would affect radio operation, but not phono to any extent, since 10 is only 10 µf and the short would only result in connecting 10 µf between 24 and ground. An open in 18 would prevent operation of the light-beam reproducer.

If a vacuum-tube voltmeter capable of indicating r.f. voltages is available, it may be used to check for voltage across the phono-bulb circuit. If voltage is found across the 3-1 terminals of 16 but not across the bulb, with 17 at maximum resistance, 18 very likely is open. It may be checked by shunting another condenser across it or by replacing it.

TELEVISION RADAR

If your television picture starts blinking, don't disturb the controls. Instead, listen for the sound of airplane motors.

The very short waves of television act like radar waves in that they may be reflected from solid bodies. When these bodies are moving, interference patterns which cause fading may be produced.

Reflections from a nearby plane often cause changes in picture brilliance. Generally these fluctuations start at about three or four per second and gradually slow down to about one a second, actually leaving the screen in darkness for an instant. Then the frequency increases again. The total effect lasts for about 8 or 10 seconds, being weaker at the start and the end. Sometimes the picture shakes from side to side instead of blinking.—I.Q.

DEALERS! ASSEMBLERS!
AMATEURS! SERVICEMEN!

TELEVISION ASSEMBLY CO. Presents — THE FIRST 10" FLAT SURFACE SCREEN PICTURE IN ASSEMBLY FORM



No Eye Strain
BRIGHT
STEADY
CLEAR

Complete with 30 tubes, 12" speaker, and specially designed di-pole antenna with 60 ft. lead-in. A 13 channel tuner with FM sound. Only nationally advertised components used in our assembly.

The logical receiver for commercial installations such as Bowling Alleys, Cocktail Bars, Restaurants, etc. Also the ideal unit for the home.

Large clear 10" flat surface picture using a direct view tube. This unit does not require a darkened or semi-darkened area. It will give you a clear bright view even in a lighted area. Easily assembled with soldering iron, screw driver, in very little time.

All major parts wired.

TERMS: 10% Dep. with Order
Bal. C.O.D.

I.F. Strip—This unit has been designed and constructed by the engineering staff of a well known manufacturer licensed by Western Electric and Radio Corporation of America. We guarantee this unit to compare in performance with any nationally known manufacturers making a similar size screen retailing at approx. list \$600, less installation.

\$229.50

COMPLETE WITH TUBES

FEATURES

- Picture I.F. Stages wired and pretuned.
- Sound I.F. Stages including Discriminator wired and pretuned.
- Video stages wired.

The above features are all contained on one chassis mounted with several screws and connected with several wires. The unit contains 13 tubes.

- Complete front end consisting of R.F. Amplifier, Oscillator and mixer wired and pretuned. The above feature is constructed on one chassis also mounted with several screws and connected by several wires. This unit contains 3 tubes.

The above units are wired and tested by our engineers for your convenience

GUARANTEED to operate to your satisfaction
when simple directions are followed

TELEVISION ASSEMBLY COMPANY

387 BUSHWICK AVE.

BROOKLYN 6, N. Y.

**"HIRE" the BEST
MAN IN THE
BUSINESS!**

TO HELP IN YOUR SHOP

For Only \$5... For Keeps!



Let him show you how to
**ELIMINATE
TEDIOUS TESTING**



It took one of the best men in the business—A. A. Ghirardi—years of time and thousands of dollars to prepare the data you get in his **RADIO TROUBLE-SHOOTER'S HANDBOOK** for only \$5. That's why this big 744-page book is AS GOOD AS ANOTHER MAN IN YOUR SHOP—and an outstanding expert at that! It eliminates tedious testing on 4 jobs out of 5! Cuts service time in half! Enables you to repair cheap sets profitably. Ideal for training new helpers!

Cuts Service time in 1/2 on 4 jobs out of 5!

Just look up the make and model of the radio you want to fix. Nine times out of ten the **HANDBOOK** gives all the detailed data you need—in 2 minutes or less. Clear instructions tell just what the trouble is likely to be—exactly how to repair it. Pays for itself first time you use it. Weighs 4 1/2 lbs. Covers specific data for practically every radio in use. Also, it gives you hundreds of helpful charts: tuning alignment data; transformer hints; tube data; color codes, etc., to help you repair any radio ever made—easier, better and faster. Only \$5 complete. **5-DAY MONEY-BACK GUARANTEE.**

Let him give you a
**COMPLETE GUIDE
to Professional
SERVICING**

Know how to make preliminary trouble checks on complicated jobs? Know how to analyze ANY circuit and its components quickly and scientifically? Know just where, when and how to use all types of test instruments—how to interpret their readings to track down the trouble?

EASY TO LEARN

Nowhere else can you get this kind of training faster, easier, and at less cost than in Ghirardi's **MODERN RADIO SERVICING**. This 1300-page book refreshes you on any puzzling type of work—prepares you for the **BIG OPPORTUNITIES** that only servicemen with the true "Know How" of their profession can grasp. 706 illustrations. 720 self-test review questions to make study easy. Weighs over 3 1/2 lbs. Only \$5 complete—and our **5-DAY MONEY-BACK GUARANTEE** means you don't really risk a cent!



MONEY-SAVING OFFER

Let the Handbook save time on common jobs. Let Modern Radio Servicing train you for **PROFESSIONAL WORK**. Get both big books for only \$9.50 for the two. Use coupon!

5-DAY MONEY-BACK GUARANTEE

Dept. RC-87, Murray Hill Books, Inc., 232 Madison Avenue, New York 16, N. Y.

- Enclosed find \$... for books checked, or send C.O.D. (in U.S.A. only) for this amount plus postage. If not fully satisfied, I may return books within five days for refund of my money.
- RADIO TROUBLE-SHOOTER'S HANDBOOK**, \$5 (\$5.50 foreign)
- MODERN RADIO SERVICING**, \$5 (\$5.50 foreign)
- MONEY SAVING COMBINATION**: Both big books—over 2040 pages—only \$9.50 for the two (\$10.50 foreign).

Name
Address
City & Zone State

New Radio-Electronic Patents

By I. QUEEN

ELECTRONIC DPDT SWITCH

Patent No. 2,396,395
J. Ernest Smith, Jackson Heights
Eugene R. Shenk, Brooklyn, N. Y.

Switching operations that must be performed rapidly and noiselessly are often done better electronically. This electronic switch circuit uses only three tubes and a few resistors.

A square wave voltage which controls the switch is applied to input e. Tube T1 conducts during a positive alternation at its grid and is cut off during the negative alternation. When it is conducting, its plate assumes a more negative potential because of current flow through R4, and its cathode becomes more positive because of the current through R3. The converse is true during tube cut-off.

The cathode of T2 is connected to the plate of T1 (through a resistor) and the cathode of T3 is connected to the cathode of T1. Making either cathode more positive is equivalent to making the corresponding grids more negative, and vice versa. Thus, when T1 conducts, T2 conducts, and T3 cuts off. When T1 is cut off, T2 cuts off, and T3 conducts.

When inputs are present at A and B the following takes place:

When T1 is conducting:

The voltage A is connected to G1 and appears at C.

Voltage B is connected to G2 and appears at D.

G3 and G4 are at cut off.

When T1 is cut off:

Voltage A is connected to G4 and appears at D.

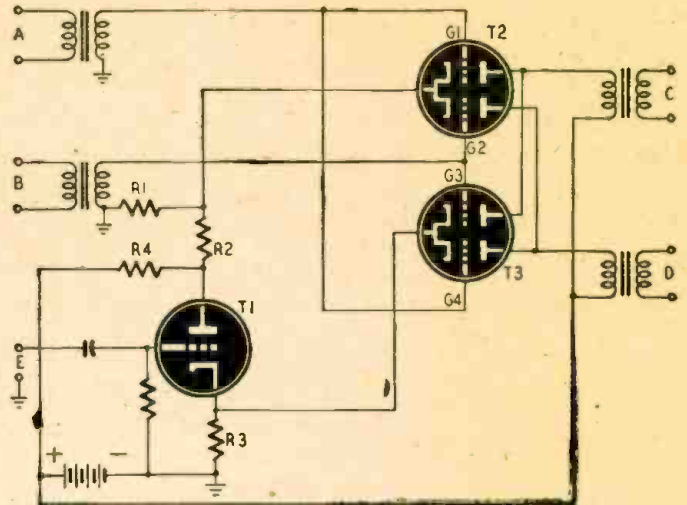

Voltage B is connected to G3 and appears at C.

G1 and G2 do not operate.

The inventor has discovered that the following relationships are optimum:

- R1 = 2R3
- R2 = 2Rp (of T1)
- R4 = R1 + R2 = 2 (R3 + Rp)

D. C. AMPLIFIER

Patent No. 2,400,734
John R. Beckwith, Chicago, Ill.

Ordinary R-C coupling cannot be used in very low-frequency and d.c. amplifiers. Instead it is required that the grid of one tube connect directly to the plate of the previous tube. Because of the relatively high potential on the grid, the corresponding cathode must also be raised to a high positive voltage. Where a number of stages are used, the total power supply voltage must be very high because each stage operates at one or more hundreds of volts higher than the last.

This circuit requires two tubes, a pentode amplifier and a triode repeater, for each stage of amplification. The plate voltage variations in the amplifier are transferred to the repeater in parallel with it. The repeater operates as a cathode follower and requires no capacitance coupling. The succeeding grid is operated at a low voltage relative to ground. Therefore the circuit does not need the

very high voltage supply characteristic of earlier d.c. amplifiers.

This great advantage is accompanied by several disadvantages, which in most cases are less important. The repeater tube, like any other, is non-linear and degeneration is added to com-

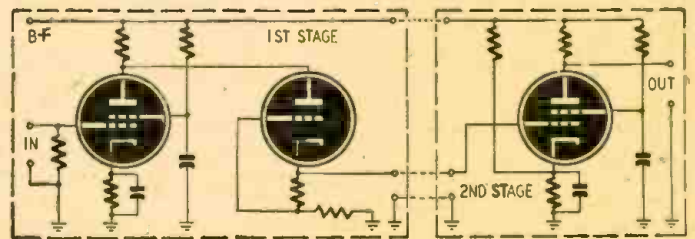

pensate for it. The gain of this tube is only 0.35 approximately and therefore more stages are required than usual. In addition, the grid of the second stage operates at a slightly positive voltage, which must be compensated for.

LIGHT RADAR

Patent No. 2,409,030
Victor H. Fraenkel and Siegfried Hansen
(Assigned to General Electric Co.)

Radar by radio is well known, but often conditions exist where echo-ranging with other forms of radiation are more suitable. For example, underwater detection is usually based on power at supersonic frequencies. This patent proposes the use of light waves.

The advantage of light as against radio is the simplicity with which sharp impulses may be generated and transmitted in narrow beams, but it is at a disadvantage in certain types of weather. The distance coverage is approximately the same for either. (Continued on page 75)

"Churchilka" Beat Nazis

ON the outbreak of World War II the Germans forbade all residents of Czechoslovakia to listen to foreign broadcasts. If anyone was caught, he was punished severely. Threats and warnings not being effective, the Nazis confiscated all broadcast receivers in many Czech and Moravian districts, as the influence of foreign broadcasting increased.

On the other hand, they wished the inhabitants of the so-called Protectorate of Moravia and Bohemia to listen to their own propaganda. Since listening to Allied stations was possible in many cases only on short waves, all short-wave circuits were taken off the receivers about the beginning of 1943. The short-wave inductors were removed and the corresponding connecting circuits opened or short-circuited.

This drastic action had little effect. All who were versed in the construction of radios (Czechoslovakia has a large number of amateurs in proportion to the number of its inhabitants) tried to replace the removed short-wave circuits in various inconspicuous ways. Short-wave resonant circuits were plugged into the phono pickup jack or directly onto the grid of the detector tube. The inductors themselves occasionally were transmission lines (i.e., pieces of ordinary double line-cord) or were mounted

inside condenser cans, line plugs, or dummy tubes.

The most interesting solution, which practically cancelled the Germans' efforts, was almost universally used in superheterodyne receivers. Since all of the ordinary oscillators in most superheterodynes produce a number of har-

monics, reaching into the short-wave frequencies, it was sufficient to insert a substitute inductor between the grid of the first detector and ground. This inductor resonated the input circuit in the short-wave bands and made it possible to receive most of the strong signals

(Continued on page 60)

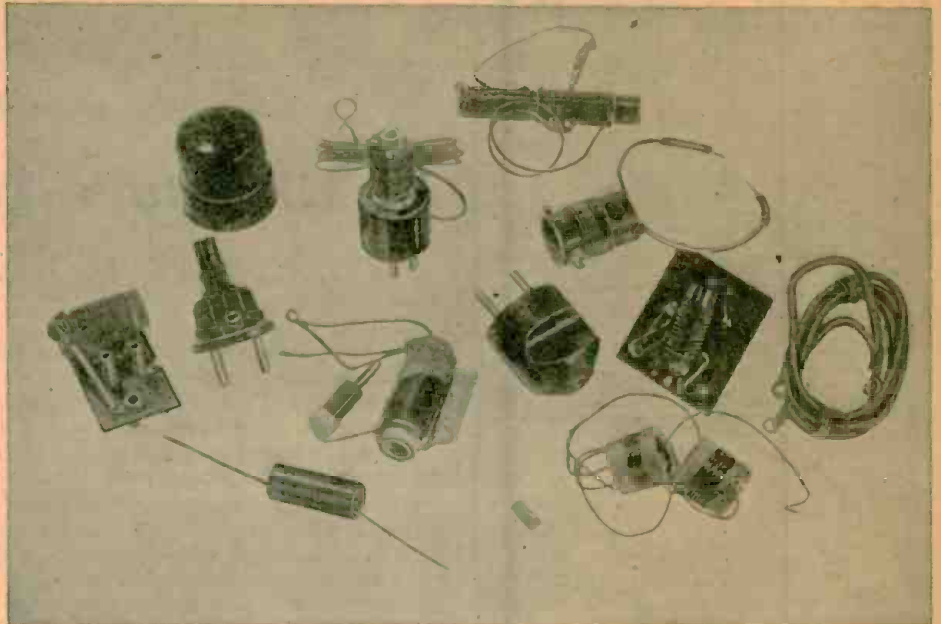

The New KT-30 CHANNEL ANALYZER!

THE ULTIMATE IN SIGNAL TRACING INCLUDES:

METER For direct reading of signal intensity.

SPEAKER For listening to the signal.

PHONE For checking distortion and listening to the signal in low-gain channels.

Intermittents, distortion and other time-consuming trouble causes can now be quickly and efficiently located and corrected with the aid of this new time-saving instrument. The use of low current consuming miniature battery tubes enabled us to provide superior performance and yet keep the size and weight of the complete instrument to its desirable compactness.

The Model KT-30 Channel-Analyzer is battery operated, therefore, it is always ready for instant use. A flip of the front panel switch and you are ready to follow the signal from antenna to speaker through all stages with the aid of the sensitive detector Probe. A high-pass filter contained in the Probe "cuts off" at 300 Cycles thus allowing a signal with a super-imposed 60 or 120 Cycle hum to be heard.

Comparative signal intensities are indicated directly on the meter as the Probe follows the signal. A special 4 1/2" P.M. speaker with oversize Alnico V magnet is used for quality checks. One of the shortcomings of many previously designed Signal Tracers has been their inability to measure and check low signal intensities. This disadvantage has now been overcome for the Model KT-30 Channel-Analyzer incorporates a special circuit which permits the meter to be put across the output of the Signal Tracer. To accomplish this it is necessary only to flip a front panel switch. This results in additional gain and sensitivity permitting measurement of low signal intensities. An earphone provided with the unit permits listening to the signal in low-gain channels. Incidentally, insertion of the phone automatically cuts out the speaker.

The Model KT-30 Channel-Analyzer comes complete with detector probe, test leads, self-contained batteries and earphone. Comes housed in heavy-gauge crystalline cabinet.

Available for immediate shipment. 20% Deposit required on C.O.D. orders.



NET PRICE **\$29⁹⁵**

GENERAL ELECTRONIC DISTRIBUTING CO.

98 PARK PLACE DEPT. RC-8
NEW YORK 7, NEW YORK

LEEDS

Still Leads— ARMY RADIO PHONES

They're perfect and were O.K.'d by Signal Corps inspectors. For battery-less phone or recordings, etc. Complete dynamic hand mike, 2 earphones, head-band, cord set and special connecting cord set. **\$345**
A real special ONLY

APS/13 RECEIVER & TRANSMITTER
17 tubes—5-6J6; 9-6AG5; 1-VR-105; 2-D21; 400-600 Mc range. 30 Mc I.F. complete with tubes & Dynamotor. Priced at less than the **\$11.95** worth of the tubes

OIL-FILLED CONDENSERS
1 MFD 600v. DC \$.39 0.1 MFD 7500v. DC \$1.50
2 MFD 600v. DC .49 0.02 MFD 8000v. DC .98
4 MFD 600v. DC .69 2 MFD 1000v. DC .79
10 MFD 600v. DC .98 2 MFD 2000v. DC 1.15
16 MFD 400v. DC .98 7 MFD 330v. DC 1.25

LOUDSPEAKER—LS-6-C consisting of microphone P.M. speaker and trumpet with triggered gun grip handle. Brand New. **\$3.95**
Special

POTENTIOMETER—100,000 ohm wire wound, precision made to General Radio specs. 25 watt. 6" diameter. Brand New **1.95**

BC-645-A TRANSCEIVER — 420-450Mc; complete with W.E. Co. 316A doorknob. 15 tubes and conversion diagram. Brand New; original packing **14.95**

METERS

0-1 MA DC 3" G. E. 3.50
0-1 amp RF 2" G. E. 2.45
0-30 volt AC 3" Westinghouse 2.45
500-0-500 microamps 4" W. E. 3.75
3" Bakelite case. 50 millivolts basic movement. can be used for any range required by use of shunts or resistors. All Brand New in boxes. **\$1.95**
Special

RELAYS—SIGMA SENSITIVE. plug-in type. 5 prong, 2000 ohms, coil set at 4Ma DC, hermetically sealed **.95**

RELAYS—G. E. HIGH CURRENT. 24v. coil; contacts will handle 200 amps. **.39**
Special

BC406 RECEIVER—15 tubes, tunes 195-207Mc; 110v 60 cy AC operated, suitable for conversion to 2 meters of television; for only... **15.95**

SELSYNS. Type 5 Synchro-transmitter, used in pairs as transmitter and follower; 110v 60 cy. AC, per pair **5.00**

SELSYNS, type 11-1; indicator type in armored case 110v, 60 cy. per pair. **9.00**

CRYSTAL PICKUPS—Well-known make, only 1½ oz. pressure; Brand New..... **1.95**

CRYSTAL MICROPHONES—Well-known make, with stand and 7 ft cable. **5.50**
Brand New

HEINEMANN CIRCUIT BREAKERS—Magnetic type, in 5-20-35-65 amp sizes.. **.95**

IN CRYSTAL DIODES for use in field strength meters; as meter rectifiers, or even for crystal sets!! at .35 each or 3 for..... **1.00**

ANTENNA SECTIONS—Screw-in type—37" long; made of light weight steel tubing; special per section **.15**

TELESCOPING ANTENNA—Very light weight. 39" long **.25**

DM-43A DYNAMOTOR. Mfg by G. E. New. input 24v at 23 amps. 7500 RPM; output 515/1030/2/8 v. at 215/260 milliamperes; filtered. **7.50**
Special

SCHWEIN Free and rate Gyros; operated from 24 v. DC in metal case, ready for use; now only **5.00**

Remote control box for 522A transceiver—consists of 5 push button switches, 5 W.E. pilot lite assemblies, lever switch, all mounted in one box **1.25**

OUNGER TRANSFORMER—Mike to grid; low to high impedance; 25 to 1 ratio. 35¢ each. **2.95**
10 for

If not rated 25% with order, balance C.O.D. All prices F.O.B. our warehouse New York.

No order under \$2.00

We ship to any part of the globe

LEEDS RADIO CO.

75 Vesey St., Dept. RCA

COntland 7-2612 New York City 7

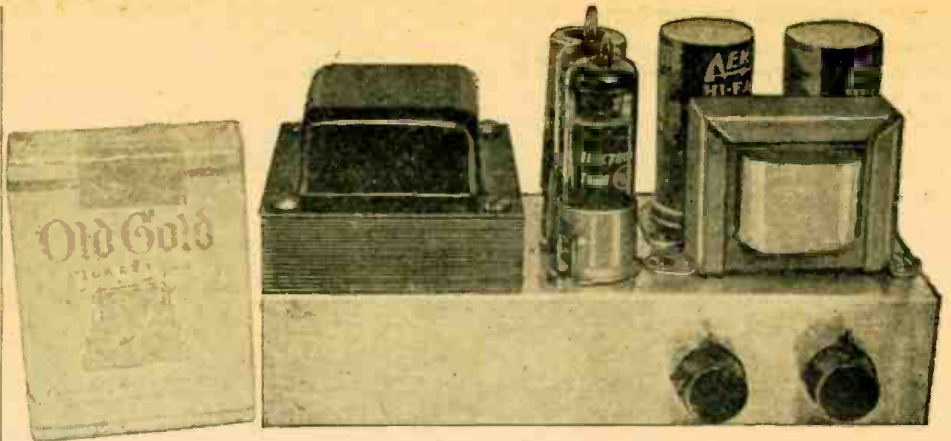

Only 3 x 5 inches in size, this little amplifier supplies 4 watts of power to the speaker.

Miniature-Tube Amplifier

By J. C. HOADLEY

It is not necessary to assemble several cubic yards of components to construct a good amplifier. It is perfectly possible to build one and, when the smoke has cleared away, find that it is no larger than several packs of cigarettes. (See photograph.) No midget in performance, it is capable of a power output in the order of 4 watts and has sufficient gain for any crystal pickup and all but the lowest-level magnetics. Even the higher-output crystal microphones will operate this amplifier.

One of the most important factors contributing to its small size is use of the new 6AQ5 miniature pentode output tube (really a 6V6 in the miniature envelope) and the 6X4 rectifier tube, the new miniature counterpart of the 6X5.

A 6AQ6 completes the tube lineup. It is a duplex-diode high- μ triode with a gain of about 70. These miniature tubes are fully the equals of their bigger brothers and have greater mechanical rigidity as well as smaller size.

The chassis dimensions are 3½ inches wide, 5 inches long, and 1¼ inches high. The chassis is made of aluminum which was obtained from a 16-inch recording disk which had been discarded. Your local broadcasting station will probably supply one, or the nearest ten-cent store will yield an aluminum cookie sheet.

The chassis may be made by bending the aluminum sheet in a vise, or a wooden block may be cut to the proper size and the aluminum bent around it as a

form. The holes are more easily cut before the chassis is bent.

This is one amplifier that can be built without critical parts. Any 40- or 50-milliamperere receiver-type power transformer will do. All 3 of the tubes operate from the one 6.3-volt winding, so the usual 5-volt winding is unnecessary. The resistors except one in the cathode circuit of the 6AQ5, are ½ watt. This lone exception should be a 5-watt resistor.

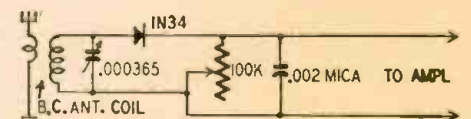

Fig. 2—A tuner useful for local reception.

Any speaker can be used, from 5 to 15 inches. If a field type is chosen, it should have a field resistance of 1,000 ohms. If a PM-type speaker is used, it will be necessary to substitute a 20-henry, 50-ma choke for the field. This can be mounted on the chassis as in the photo, and the speaker should have an output transformer mounted on it. If a field-coil model speaker is used, the output transformer may be mounted in place of the choke. The output transformer should have an impedance of from 5,000 to 8,000 ohms. The usual value is 7,000 ohms, but is not too critical.

The speaker should be mounted on a box to serve as a baffle. For best results,

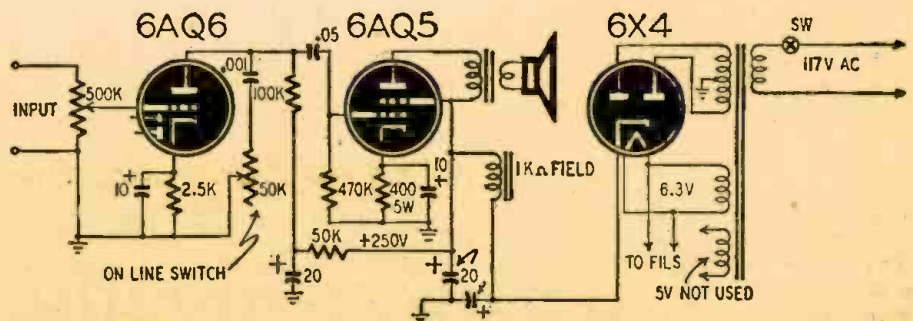

Fig. 1—The circuit. For PM use, a 50 ma choke may be employed instead of the speaker field.

it should be of the bass-reflex type. For a discussion of bass reflex, refer to the article in RADIO-CRAFT, November, 1946.

In wiring the amplifier, it is necessary only to keep the wires to the volume control away from the a.c. wires on the power transformer or hum may result. When the unit is completed, connect the input to a crystal pickup or tuner.

The small size of the finished unit adapts it for placement almost anywhere, even in a cigar box, together with a 4- or 5-inch speaker, and perhaps even a motor and pickup to make a miniature portable record player.

For those individuals who like their radios in small doses, a small variable condenser, a coil, and a 1N34 crystal constitute an ultra small radio receiver which can be connected to the small amplifier and although short on selectivity and sensitivity, will provide unusual fidelity on a strong local station (see Fig. 2). These variations allow the experimenter a lot of leeway without a vast expenditure, so let's see what you can do with this *mighty mite*.

Radio Thirty-Five Years Ago

In Gernsback Publications

HUGO GERNSBACK

Founder

Modern Electrics	1908
Electrical Experimenter	1913
Radio News	1919
Science & Invention	1920
Radio-Craft	1929
Short-Wave Craft	1930
Wireless Association of America	1908

Some of the larger libraries in the country still have copies of ELECTRICAL EXPERIMENTER on file for interested readers.

From August, 1913, ELECTRICAL EXPERIMENTER:

Measuring the Intensity by Wireless Signals, by *P. Mertz*

New System of Wireless Telegraphy Moon Affects Wireless

Rotary Spark Gaps and their Construction, by *Henry Scott*

New High-Frequency Alternator A Long-Distance Radio Set, by *Edward A. Werner*

Wave-Length Calculations Radio Buzzers

BIGGEST HAMFEST COMING

AMATEURS of New Jersey and nearby parts of several neighboring states will meet September 26-28 at Asbury Park, N. J., in the most ambitious amateur radio convention since the war. Activities are expected to be so extensive that even with the 3-day convention it will be necessary to run various activities simultaneously.

It is expected that Amateur Radio K2USA will be on the air at the convention hall, which is located directly over the Atlantic Ocean. A visit to the radar with which the moon was contacted is another of the projected activities open to delegates.

The convention is being sponsored by the Jersey Shore Amateur Association and the Monmouth County Amateur Radio Association.



The one word "greatest" best describes new MODEL 906 Signal Generator . . . greatest frequency range of 90 kc. through 170 mc. AM; 90 kc. through 210 mc. FM . . . greatest calibration accuracy of 1% . . . greatest output range — metered and continuously variable from less than 1 microvolt to over 1 volt . . . greatest freedom from strays . . . greatest "buy" in history at only \$89.90 net.

Exactly as the unequalled excellence designed and built into "VOMAX" makes it outstanding the preferred, truly universal v.t.v.m., so SILVER engineering brings you in MODEL 906 a signal generator utterly without equal.

"VOMAX"

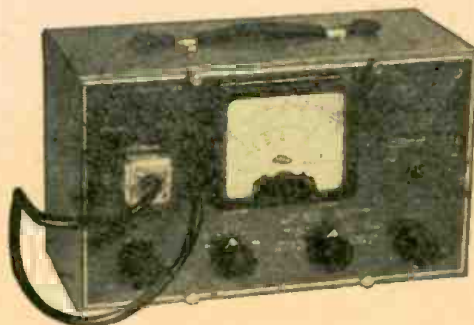

NEW FLEXIBLE PENCIL R. F. PROBE

For two years "VOMAX" has stood head and shoulders above all other meters for a.c., a.f., i.f., r.f. and d.c. voltage range . . . unequalled current and resistance ranges . . . laboratory accuracy . . . high meter input resistance . . . far real value.

Now "VOMAX" is equipped with a new, pencil-thin r.f. probe extension 5" long plus companion grounding clip and lead. With it you can reach any point in the "tightest" midget receiver chassis . . . you can bend the probe around corners if you have to! This exclusive new SILVER

development maintains "VOMAX" as the finest, most complete meter you can buy . . . still for only \$59.85 net. Present "VOMAX" users can get the new flexible pencil probe kit for 35c from their jobber.

NEW 16-PAGE CATALOG. Mail a penny post-card for complete data on these and other new SILVER products . . . famous "SPARX" visual and aural signal tracer, laboratory condenser/resistor tester, new amateur xtal-controlled all-band exciter, 80 thru 6 meter 40-watt pre-tuned frequency multiplier, transmitters, receivers, etc.

OVER 36 YEARS OF RADIO ENGINEERING ACHIEVEMENT

McMurdo Silver Co., Inc.

1240 MAIN ST., HARTFORD 3, CONNECTICUT

**HAMS! HERE'S THE
BEST CONVERTER BUY
ON THE MARKET...**



**Kit or Completely Assembled
Lafayette CONVERTER
For 6, 10 and 11 meters**

Frank Lester, famed W2AMJ, back in charge of ham radio at Lafayette, comes through with a great ham innovation that you'll want right now!

Another Lafayette plus is Frank Lester's interesting and informative article on this converter, in the August issue of Radio News.

Designed to operate directly from 105-125 volt 60-cycle A-C source, this converter uses the new selenium rectifier and three new-type miniature tubes. One 6BA6 as tuned R-F stage—one 6BE6 as mixer—one 6C4 as H-F oscillator. Single-dial tuning for controlling H-F oscillator—separate control for R-F stage. This feature eliminates tracking error. Mixer gain may be varied by separate bias control, thus permitting optimum signal-to-noise ratio regardless of receiver used. Stand-by switch controls both converter and receiver. Plug-in coils employed for all bands, one set to cover 50 to 54 mc range and another to cover from 27.180 to 29.7 mc. Output transformer adjustable from 4.7 to 6.5 mc. Kit comes complete with punched chassis, panel and cabinet as well as all parts for one band and complete instructions, less tubes. Gray crinkle cabinet 8" x 12" x 8". Shpg. wt. 15 lbs.

- K10454—Converter kit, less tubes—Your Cost only\$34.50
- K21000—Tubes for converter—Your Cost only 3.00
- K10456—Converter completely assembled, wired and tested with coils for 6, 10, 11 meter operation, including all required tubes—Your cost only 49.50

**WIRED CONVERTER SOLD ON
10 DAY MONEY BACK GUARANTEE!**

Write today for our big, new 144-page catalog—it's chock full of everything you want in radio and electronics. Ask, too, for flyer C-39 with its up-to-the-minute news on ham bargains.

Lafayette Radio

(RADIO WIRE TELEVISION, INC.)

100 Sixth Avenue 110 Federal St. 24 Central Ave.,
New York 13, N. Y. Boston 10 Newark 2, N. J.

New Superregenerator

By MARION BLACK

A special variometer gives this set wide tuning range

An improved and expanded version of the superregenerator described in the *Radio-Electronic Circuits* section of the April, 1945, issue of RADIO-CRAFT, this set has a built-in all-wave antenna constructed like a variometer to provide coverage from far above the broadcast band to well down into the short wave spectrum.

The circuit uses a 37 superregenerative detector with external quenching voltage supplied from another 37 in a low-frequency oscillator circuit. Any convenient triode would no doubt work. The detector also feeds into a 41 power amplifier that may be used to drive a speaker or to supply higher output for phones.

The all-wave built-in antenna coil can be constructed by anyone with average ability and little material. Two series-connected coils are employed, on the principle of the variometer. The coils are approximately 6 inches in diameter, and are preferably wound with about 6 turns each. When the coils are so turned that they aid each other they will cover the broadcast range. When set so they oppose they will tune far up in the short-wave spectrum.

The coil forms can be made of bakelite or wood. Mine were of cardboard, stiffened with well-thinned coil cement (any cellulose lacquer or airplane dope will work well). The inner coil was made about 5 1/4 inches in diameter. Six turns were wound on it, 3 on each side of the shaft. They were well cemented down and when dry a strip of heavy cardboard was wrapped around the winding. The second winding was put on this, just tight enough to keep it from falling off. Next I put cement on the inside of the outside cardboard strip, wrapped it around the winding, and tied it in place. When everything was thoroughly dry the middle cardboard was slipped out, and the result was a variometer with windings that fitted very close together in positions of maximum and minimum inductance. The photograph gives a good idea of its appearance, which I will admit could be improved.

To further increase the frequency

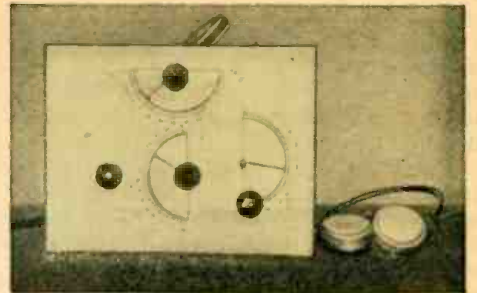

Front view of the superregenerative receiver.

range of the coil, two sets of tuning condensers are connected across each end of the variable inductor. One set of tuning condensers—2-gang variables—tune the grid and plate circuits of the high-frequency oscillator. The other acts as a connecting link in the middle of the variable inductor and makes a good band-spread tuner. The setting of the variable inductor and the grid-plate tuning condenser determines the wave band.

Another interesting feature of this set is that the aerial connects to the chassis if an outside aerial is used. The set will pick up most of the local stations and many short-wave stations without an outside aerial. An aerial will greatly increase the range of the set. With 10 turns on each half of the variable inductor I got a frequency range from 9 megacycles to 9 kilocycles.

I used 0.000015- to 0.0004-microfarad tuning condensers on the band-spread end of the variable inductance, and 0.000012 to 0.00035 tuning condensers

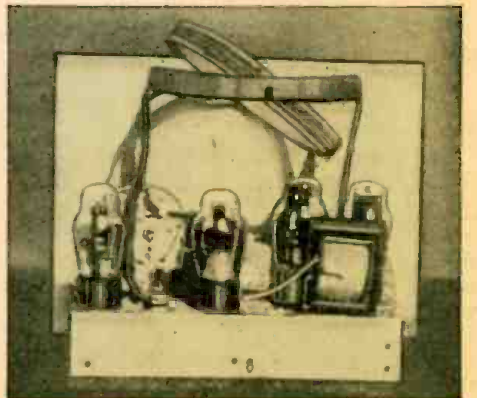

The home-made variometer is well shown here.

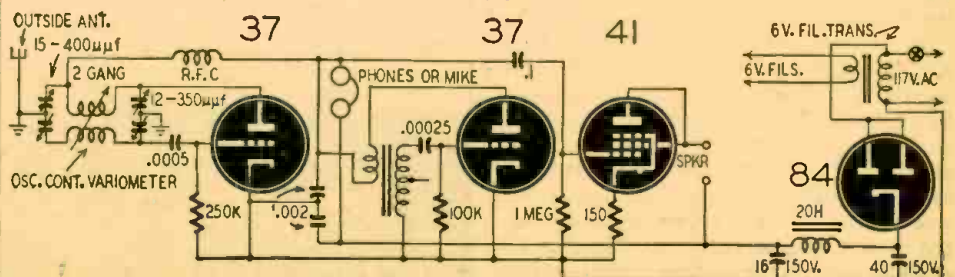

Note that phones act as choke. For safety a condenser should be used in aerial circuit.

across the grid and plate ends of the inductor. 365 μ f 2-gang condensers can be used in both positions. The chassis of the set in connection with the large variable inductor acts like a small aerial and is balanced in such a way with the tuning condensers that any aerial you use can be tuned to the frequency you are trying to pick up. With both set and aerial tuned to the desired frequency, the set becomes supersensitive.

The grid part of the built-in aerial is mounted horizontally above the tubes and the plate part swung inside so it rotates. Part of the time this plate coil is vertical and part of the time horizontal, according to how it is set. The grid loop, being horizontal, picks up stations from every direction equally and thus nullifies the directional loop effect.

I added one audio amplifier to the set to bring in especially weak stations on the headphones. It will operate a small speaker on local stations. An audio choke and a circuit-opening jack may be inserted in the plate circuit of the detector tube so that taking out the phones inserts the choke, making it possible to use the same pair of phones for 1-tube or 2-tube reception. The power supply, superregenerative receiver, and audio amplifier are all shown in the diagram. I built the whole thing on the chassis of an old 4-tube t.r.f. radio receiver.

MAPS MADE BY RADAR

(Continued from page 19)

of radar photographs. The radar photos were made by a Radiomarine 3-2 centimeter radar.

In making a radar mosaic, Mr. Pannill explained, an automatic camera is attached to the radar instrument and adjusted to photograph images on the scope at regular intervals. The prints are then matched to produce a continuous strip-map reduced to the scale of standard navigation charts. On the assembled charts, engineers add dotted lines indicating the channel to be followed, together with figures showing the depth of water, and brief identifying descriptions of landmarks.

According to Brigadier General Douglas Weart, Ohio River Division Engineer, the importance of this development in chart-making is "comparable only to the introduction of steam power on the river.

"By using radar and radar charts," General Weart said, "it is possible for a pilot to know exactly where he is and 'see' the obstacles before him regardless of fog—one of the bugbears of river navigation—or other soupy weather. Each image on the radarscope, whether showing an island, shoreline cliff, a building or a cluster of gas storage tanks, will be as recognizable as if the pilot were seeing the landmark itself."

The cost of charting a river by radar, it has been pointed out, would be low in comparison to the savings that owners of the 3.2-centimeter radar equipment could make through the general speeding-up of traffic and the elimination of delays due to weather conditions.

GOVERNMENT RADIO and ELECTRONIC SURPLUS BARGAINS

MODEL AN-PRS-1

NEW

MINE DETECTORS

EACH \$9⁹⁵



We still have a supply of

TG 10 KEYERS

NEW

EACH \$15⁰⁰

TUBES

C6J (CE 306)

GRID CONTROLLED RECTIFIER Gas Filled

Maximum Anode Amperes 6.4
Nominal D.C. Output Volts 350
Output Volts 350
Filament:
Amps 18
Volts 2.5
Heating Time 40 Secs.
Peak Inverse Volts 1250
Peak Anode Current 77
Critical Grid Voltage -2
Cond. Mercury Temp. Limits 40° to 65° C.
Height 9 1/2", Width 2 1/16"
Base: 4 pin No. 412

PRICE EACH \$3⁹⁵

3B22 (CE222)

FULL WAVE RECTIFIER XENON FILLED

Maximum Anode Amperes 1
Nominal D.C. Output Volts 200
Filament:
Amps 6
Volts 2.5
Heating Time 20 Secs.
Peak Inverse Volts 725
Maximum Average Ignition Voltage 12
Arc Drop Average 8
Cond. Mercury Temp. Limits 40° to 65° C.
Height 6"
Width 1 1/8"
Base: Medium 4 Pin

PRICE EACH \$1⁹⁵

4B24 (CE 224)

FULL WAVE RECTIFIER XENON FILLED

Maximum Anode Amperes 2.5
Nominal D.C. Output Volts 200
Filament:
Amps 12
Volts 2.5
Heating Time 30 Secs.
Peak Inverse Volts 725
Maximum Average Ignition Voltage 12
Arc Drop Average 8
Cond. Mercury Temp. Limits 40° to 65° C.
Height 7 1/2"
Width 2 3/16"
Base: Medium 4 Pin

PRICE EACH \$2⁹⁵

INVERTERS

27 V. Input, 115V. 400 Cycle Output at approximately 1500 Watts.

NEW, EACH \$7⁹⁵

GRAB BOX

Approximately 10 lbs. of miscellaneous radio parts. All usable—All new.

BOX EACH \$1⁰⁰



MIDGET I. F. TRANSFORMERS

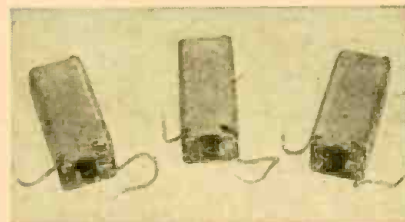

455 K.C. Slug Tuned NEW

3 for \$1⁰⁰

HIGH VOLTAGE TRANSFORMERS

90 V. Primary, 6400 V. Secondary, approx. 100 Mills. NEW, EACH

\$1⁹⁵

OUTPUT TRANSFORMERS

Type No. 900885 CRV-30528
PRI-5000 Ohms
Sec. #1 500 Ohms Modulator
Sec. #2 600 Ohms Sidetone

RESISTANCE

PRI-120 Ohms
Sec. #1-20 Ohms
Sec. #2-5 Ohms

NEW, EACH \$49^c

All Orders F.O.B. DETROIT, Shipped RAILWAY EXPRESS

RADIO CENTER

2530 EAST DAVISON AVE.
DETROIT 12, MICHIGAN

No order under \$5.00 — Please send check or money order. Orders shipped C.O.D. subject to 25% advance deposit.

**FOR BETTER BUYS SEE
HIGHBRIDGE**

RANGEMASTER



**MODEL 10
A COMPLETE
SERVICE
INSTRUMENT**

COVERS THESE RANGES

A.C. Voltage: 1-10-100-500-1000 Volts
D.C. Voltage: 10-100-500-1000 Volts
A.C. Current: .05-.15 .5-1.5 5-15 Amperes
D.C. Current: 1-10-100-1000 Milliamps
Resistance: RX10 RX100 RX1000 Ohms
Capacitance: .001-.1 .01-1 1-10 Mfd.

Available in Kit Form \$16.95
Factory Assembled \$23.50
Test Leads 85c

BRAND NEW

7EP4

IMMEDIATE DELIVERY

Individually packed — in original cartons—Guaranteed \$19.50

**WESTERN ELECTRIC
INPUT TRANSFORMER**

Video core type; imped. ratio between windings: 1-2, 3-4, 5-6, in parallel 50-900 ohms; Freq. range 10 KC to 2 MC; made for set AN/APQ-13; Electrostatic shield between windings, oil filled; 5 1/2" diameter, 5" high, wt. 5 lbs. \$1.95

SELETRON SELENIUM RECTIFIERS

50 to 9985
6 to 4990
1 to 599



Quotations on larger quantities furnished upon request

USEFUL FOR: ★ AC-DC Portables ★ Intercom Power Supplies ★ Console Radios ★ Replaces 29 Types of Rect. Tubes

K8-9524—Transformer Pri. 115 V—60 cycles. Sec. #1—450 V @ 30 MA C.T. Sec. #2—6.4 V @ 1250MA. Rectangular metal case, stud mtg. solder eyes—approx size 3 1/16 x 2 5/16 x 3 3/8 with standoff

No. T2G-97. Special. \$1.95

1.R. #7313 Filament Trans. 115 V—50-60 cycle. Sec. #1—27 KV @ 4.3 amps No. C.T.—Sec. #2—5.1 V @ 3 amp C.T.—Sec. #3—6.4 V @ 3 amp No. C.T.—Sec. #4—5.1 V @ 3 amp C.T.—Sec. #5—2.6 V @ 3.5 amps No. C.T.—Rectangular metal case, solder post terminals; Mtd on porcelain standoffs; stud mtg. size 5/8 x 4/8 x 5/8 with standoffs 6 3/4
T2E-88. Special. \$4.95

NEW No. 631PI/SNA Glass Strobotron tubes. Each \$3.25
100 By-Pass Condensers, 10 Varlettes. Special. \$4.95

High voltage transformer with Glass Standoffs. Pri. 115 V. A.C.—400 cycle—Sec. 5700 V. Rectangular; approx. size 6 3/8 x 4 3/8 x 3 3/8 with standoff 7 3/4—13 Mills D.C.
T3F-7. Special. \$3.95

TUBES

12A683 6SN779
6SQ783 6J1783
6AJ5 1.25 6C479
162570 5PB15.95

All Prices FOB New York City, N. Y.

**HIGHBRIDGE RADIO-TELEVISION
& APPLIANCE CO.**

343 CANAL NEW YORK 13, NEW YORK

ELECTRONIC COUNTING

(Continued from page 26)

to be counted pass between the light source and the phototube in such a way as to intercept the light beam. It may be used to count pedestrian and automobile traffic, or any other type of transient object. It is particularly useful in modern industry for counting items of manufacture passing along a conveyor belt (Fig. 1) or down a chute.

Speed of counting is limited only by the ability of the magnetic or mechanical recorder to enumerate the output pulses of the counting circuit.

Step-by-step counter

Another arrangement of 2 diodes (Fig. 2) produces an output "step voltage."

The 2 diodes provide a charge on condenser Cs, whose value is about 10 times that of condenser C.

Each positive-going input pulse increases the charge on condenser Cs, producing a step voltage across the output of the counting circuit (Fig. 2). The steps decrease in size exponentially as

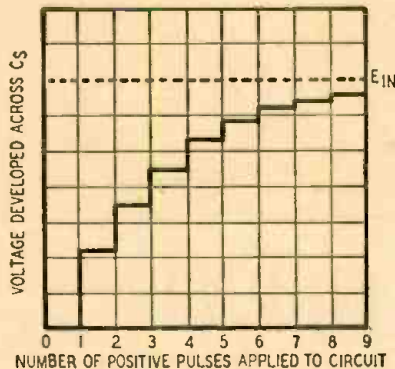

Fig. 3—Output of a step counting circuit.

the voltage across condenser Cs approaches its maximum value (Fig. 3).

When the counting circuit is unconnected or connected to a very high impedance load, there is no direct path through which condenser Cs can discharge. Thus the effective voltage increases until it is about equal in amplitude to the input pulses. At such point the cathode of the second diode is held at a positive voltage equal to the plate voltage during the pulse period, and the diode does not conduct.

In practice, however, such a counting circuit is normally connected to a sensitive circuit, such as a blocking oscillator, a ringing oscillator, or a multi-vibrator arrangement. And maximum output voltage seldom reaches or even approaches the peak value of the input pulses, because of the effect of the output load on the rate of charge of condenser Cs.

But this is not usually important, since the output circuit is so arranged that it is triggered into action at a certain value along the step output-voltage curve (Fig. 3).

The value of the output voltage is determined by the number of input positive-going pulses originally applied to

the counting circuit.

This process of step-by-step counting is also known as frequency division, and is widely used in electronic apparatus requiring submultiple measurement of high-speed input impulses.

A simple thyatron-relay circuit (Fig. 4) illustrates a conversion from electronic to mechanical energy. The counting circuit is controlled by positive going input pulses.

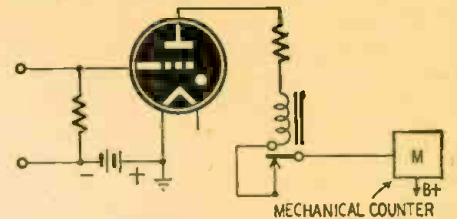

Fig. 4—A simple circuit with a thyatron.

Whenever the grid of the gas-filled tube becomes more positive than the striking potential, current flows in the plate circuit of the thyatron, the relay is energized, and the armature or counting arm of the relay operates any type of magnetic or mechanical counting device.

Removal of the control voltage from the thyatron stops the flow of plate current, and resets the armature of the relay for the next impulse.

Scaling circuits

Due to mechanical limitations of the counting device, there is an upper limit to the frequency at which input pulses can be applied to such a counting circuit.

To measure a succession of input impulses occurring above this limit, a form of frequency division known as scaling is employed.

An electronic scaler provides a single output pulse for a particular number of input pulses; the output is in numerical ratio to the input.

A typical scaling circuit (Fig. 5) uses two thyratrons to operate a mechanical switch M, which functions only during every other impulse.

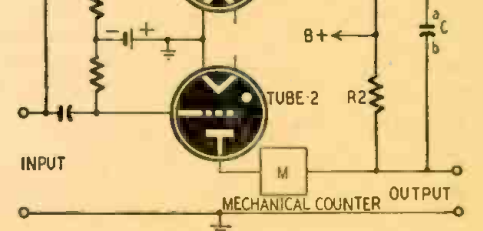

Fig. 5—Thyratrons in a scale-of-2 circuit.

A typical scaling circuit (Fig. 5) uses two thyratrons to operate a mechanical switch M, which functions only during every other impulse. In quiescent condition, tube 1 conducts, tube 2 is shut off. The plate current of tube 1 flowing through resistor R1 charges condenser C positively on its lower plate, negatively on its upper plate. Application of the first positive-going input pulse does not affect the plate current of tube 1. However, it makes the grid of the other

thyatron less negative, so that the tube strikes and conducts. This conduction activates the mechanical counter M and a voltage drop is produced across resistor R2. Condenser C discharges through R1, causing a total voltage across R1 of such magnitude that the plate voltage across tube 1 falls to zero. Thus, by allowing thyatron 2 to conduct and by reversing the polarity of condenser C, thyatron 1 is automatically cut off.

A second input pulse causes tube 1 to strike. Conduction of tube 1 shuts off tube 2, thus resetting the mechanical meter for the next input pulse.

The magnetic or mechanical indicating device counts every second impulse, and is said to have a scale of 2. By cascading such scale of 2 circuits, it is possible to construct electronic counters having a scale of 4, scale of 8, scale of 32, or even scale of 64.

Counters using such extremely high scalar values are frequently used in atomic and nuclear measurements. A typical device of this type with a scale of 64 (see photograph) is used for radio-activity detection and measurement.

Special circuits

A coincidence counter is a double-input counting circuit, somewhat similar to the single-input system (Fig. 1). The circuit is so arranged that two input pulses are required—each to occur at each input almost simultaneously—to actuate a conventional counting device in a secondary stage. Impulses applied to only one input, or random impulses applied to both inputs, will not permit the coincidence counter to function.

Grading and sorting circuits may be simple or complex, depending on the number of grades or arrangements into which the objects are to be sorted. Phototubes and color-lens systems are widely used for grading and sorting.

The simplest sorting circuit uses two phototubes and a single beam of light to classify and sort objects into two groups: larger and smaller than a certain size. As the beam of light passes over the objects to be sorted, the beam energizes one of the phototubes, depending upon the height or size of the objects. Relays connected to each phototube activate mechanical sorting devices.

Colors are identified with phototubes and arrangements of color filters. Somewhat similar circuits can be used to indicate color discrepancies. Typical of such an arrangement are the recently developed RCA electronic bean sorters, equipped with phototubes for eyes and a cathode-ray tube for a brain. (Fig. 6.)

Acceptance or rejection depends upon the respective percentages of red and green light reflected by each bean.

Mechanical design of each machine (Fig. 6) provides for feeding the beans, one at a time, through an optical system consisting of a strong incandescent lamp, focusing lens, two mirrors, and two phototubes. The first mirror reflects about half of the light through a red color filter to the first phototube; the second mirror reflects remainder of

(Continued on page 60)

new

CONCORD Radio Catalog

RADIO PARTS • RADIO SETS
RECORD CHANGERS • PLAYERS
HAM GEAR • AMPLIFIERS • TESTERS

This is it—the new 1947 Concord Catalog—a vast, complete selection of everything in Radio and Electronics—thousands of items available for IMMEDIATE SHIPMENT from CHICAGO or ATLANTA—hundreds now available for the first time—featuring new, latest, 1947 prices. See new LOWER prices on RADIO SETS, PHONO-RADIOS, RECORD CHANGERS, RECORD PLAYERS, PORTABLES, AMPLIFIERS, COMPLETE SOUND SYSTEMS, TESTERS. See latest listings of standard, dependable lines of radio parts and equipment—tubes, condensers, transformers, relays, etc. Mail coupon for FREE COPY—NOW!

TIME PAYMENTS: Write us for details of time payment plan on Communications Receivers, Amplifiers, Test Equipment, Radios, Phono-Radios, etc.

CONCORD
RADIO CORPORATION
A FAYETTE RADIO CORPORATION
CHICAGO 7, ILL. ATLANTA 3, GA.
901 W. Jackson Blvd. 265 Peachtree St.



free

Mail COUPON TODAY!

Concord Radio Corporation, Dept. RC-83
901 W. Jackson Blvd., Chicago 7, Ill.
Yes, rush FREE COPY of the comprehensive new
Concord Radio Catalog.

Name.....
Address.....
City..... State.....

WORLD-WIDE STATION LIST

(Continued from page 39)

6.040		ALGIERS, ALGERIA: 1230 to 1800.	6.280	HCJB	QUITO, ECUADOR: 1800 to 2200.
6.040		RANGOON, BURMA: 0030 to 0230;	6.190	HI1A	SANTIAGO, DOMINICAN RE-
		0615 to 0830; 2100 to 2145.			PUBLIC: 1600 to 1800.
6.040	COBF	HAVANA, CUBA: 0800 to 2300.	6.200	HJCT	BOGOTA, COLOMBIA: 1000 to 1400;
6.040	XETW	TAMPICO, MEXICO: 0745 to 0045.			1800 to 2315.
6.060		TETUAN, SPANISH MOROCCO:	6.200	YV6RO	CIUDAD BOLIVAR, VENEZUELA;
		0230 to 0300; 1330 to 1830.			1700 to 2315.
6.070	GRR	LONDON, ENGLAND: 2300 to 0030.	6.200	FK8AA	NOUMEA, NEW CALEDONIA: 0200
6.070	CFRX	TORONTO, CANADA: 0800 to 2345.			to 0400; 1900 to 2000.
6.070		BERLIN, GERMANY: 0000 to 0345.	6.310	HI1Z	CIUDAD TRUJILLO, DOMINICAN
6.070		COLOMBO, CEYLON: 1930 to 0545;			REPUBLIC: 1600 to 2255.
		0715 to 1200.	6.330	COCW	HAVANA, CUBA: 0600 to 2400.
6.080	WLWK	CINCINNATI, OHIO: 1830 to 0100.	6.340	HE1Z	BERNE, SWITZERLAND.
6.080	CKFX	VANCOUVER, CANADA: 0930 to	6.360	HRP1	SAN PEDRO SULA, HONDURAS;
		0300.			1100 to 1415; 1800 to 2255.
6.090	LYR1	BUENOS AIRES, ARGENTINA: 0545	6.370	CSX	LISBON, PORTUGAL: 1330 to 1900.
		to 0715; 1800 to 2100.	6.450	COH1	SANTA CLARA, CUBA: 0700 to 2345.
6.090	CBFW	LUXEMBOURG: 1430 to 1700.	6.480	HI2T	MONSIEUR NOEL, DOMINICAN
		MONTREAL, CANADA: 0730 to 1945;			REPUBLIC: 1600 to 2400.
		2000 to 2100.	6.510	CP40	COCHAHAMBA, BOLIVIA: 1930 to
6.090	ZYB7	SAO PAULO, BRAZIL: 1600 to 1950.			2200.
6.100	VUD10	DELHI, INDIA: 0830 to 0915; 2030	6.530	TGWB	GUATEMALA CITY, GUATEMALA;
		to 2200.			0800 to 1200; 1830 to 0100.
6.100	PRE9	WARSAW, POLAND: 1330 to 2100.	6.620	TG2	GUATEMALA CITY, GUATEMALA;
6.100	GSL	FORTALEZA, BRAZIL: 1530 to 2100.			1800 to 2300.
6.110		LONDON, ENGLAND: 1500 to 1745;	6.710	ZL77	WELLINGTON, NEW ZEALAND;
		1900 to 0030.			0615 to 0450.
6.120	HP5H	PANAMA CITY, PANAMA: 0700 to	6.720	PMA	BANDONG, NETHERLAND IN-
		2300.			DIES.
6.130	XEUZ	MEXICO CITY, MEXICO: 1500 to	6.750	JVT	TOKYO, JAPAN.
		0030.	6.760	YNDS	MANAGUA, NICARAGUA: 0800 to
6.130	CHNX	HALIFAX, NOVA SCOTIA: 0700 to			1000; 1700 to 2330.
		2300.	6.770	CP49	LA PAZ, BOLIVIA: 0700 to 0900;
6.130	COCD	HAVANA, CUBA: 0700 to 2400.			1100 to 1200; 1930 to 2100.
6.140	HJDE	MEDELLIN, COLOMBIA: 1100 to	6.770		SINGAPORE, MALAYA: 0845 to
		2300.			0935.
6.150	GRW	LONDON, ENGLAND: 1445 to 1500;	6.850	YNOW	MANAGUA, NICARAGUA: 0800 to
		1900 to 2215; 2330 to 2345.			2300.
6.150	CKRO	WINNIPEG, CANADA: 2200 to 0300.	6.910	YNQW	MANAGUA, NICARAGUA: 1300 to
		BELGRADE, YUGOSLOVIA: 1130 to			2300.
		1800.	6.980		MOSCOW, U.S.S.R.: 1600 to 1745;
6.150	EQB	TEHERAN, IRAN: 1000 to 1415; 2230			2315 to 2345.
		to 2400.	6.980	F08AA	PAPEETE, TAHITI: Tuesdays and
6.150	TIRH	SAN JOSE, COSTA RICA: 2130 to			Fridays, 2200 to 2400.
		2400.	7.010	XPSA	KWEIYANG, CHINA: 2330 to 0030;
6.150	CSWD	LISBON, PORTUGAL: 1430 to 1900.			0450 to 0800.
6.160	HJCD	BOGOTA, COLOMBIA: 0700 to 0800.	7.100		BISSAU, PORTUGUESE GUINEA;
6.160	CBRX	VANCOUVER, CANADA: 0900 to			1600 to 1730.
		0200.	7.120	GRM	LONDON, ENGLAND: 1145 to 1215;
6.160	HHCM	PORT AU PRINCE, HAITI: 0500 to			1445 to 1515.
		0630; 1100 to 1400; 1700 to 2145.	7.130		HARGEISHA, BRITISH SOMALI-
6.160	HER3	BERNE, SWITZERLAND: 0030 to			LAND: 0800 to 1030; 1200 to 1300.
		0130; 0245 to 0700; 1200 to 1700.	7.150	XGOY	CHUNGKING, CHINA: 0630 to 1130.
6.230	HRD2	LA CEIBA, HONDURAS: 1200 to			VIENNA, AUSTRIA: 0000 to 0200;
		1400; 1900 to 2300.			0600 to 0800; 1000 to 2030.
6.240	HJCF	BOGOTA, COLOMBIA: 1700 to 2300.	7.160		CAIRO, EGYPT: 0200 to 0300; 1500
6.240	HI1N	CIUDAD TRUJILLO, DOMINICAN			to 7; 2230 to 2400.
		REPUBLIC: 1600 to 2230.	7.190	JCPA	

LEARN ELECTRIC MOTOR REPAIR

NO WONDER IT'S A GOOD BUSINESS!

According to no less an authority than the General Electric Co., there are **ELEVEN MOTOR-OPERATED DEVICES** in the average moderate-income American home! Many large homes have twice this many motors—in washers, refrigerators, oil burners, cleaners, fans, clocks, shavers, mixers, etc. Be the man who can repair them! It's a logical addition to any radio business!



ELECTRIC MOTOR REPAIR

This big book shows you how every step of the way

ONLY \$5 complete

It Pays to Specialize in SOMETHING DIFFERENT!



ELECTRIC MOTOR REPAIR—the big new book by the publishers of famous Ghrardi Radio-Electronic books—teaches you motor repair work at home, in spare time. Written by a leading vocational school instructor, it explains every detail of motor trouble diagnosing. Tells exactly how to handle all types of work from minor repairs and adjustments to complete rewinding. Covers a-c and d-c motors, synchronous motors and generators and mechanical and electrical control systems.

Based on what you can learn from this 580-page book alone you can train for prompt, profitable service on practically any type of electric motor in common use.

EASY TO UNDERSTAND

Everything is easy to understand. All problems explained step by step in BOTT text and over 900 special illustrations. Quick reference guides show exactly how to handle specific jobs. Ideal, either for beginners or for daily bench use in busy shops.

Train now for big money in an uncrowded, wide-open field!

BORROW IT FOR 5 FULL DAYS

Practice from **ELECTRIC MOTOR REPAIR** for 5 days repairing your own home motors or those of friends. If not more than satisfied, return book and every cent will be cheerfully refunded. Send coupon now!

NO RISK COUPON mail today

Dept. RC-87, Murray Hill Books, Inc., 232 Madison Ave., New York 16, N. Y.

Enclosed is \$5 (\$5.50 outside U.S.A.) for a copy of **ELECTRIC MOTOR REPAIR** book; or send C.O.D. for \$5 plus postage (no foreign C.O.D.'s). In either event, if not satisfied, it is understood I may return book in 5 days for complete refund of my money.

Name
Address
City & Zone State

ELECTRONIC COUNTING

(Continued from page 59)

light through a green filter to second phototube. Output of each phototube is then amplified and applied to one of two pairs of deflection plates of an electrostatic cathode-ray tube. The degree to which the beam is deflected in either horizontal or vertical direction is determined by the respective amounts of red and green light reaching the phototubes. Output of either phototube is strongly influenced when a sub-standard beam is examined by the opti-

cal system, which in turn affects the sweep of the electron beam so that no image is seen on the face of scope. A third phototube, located close to the screen of the cathode-ray tube, is actuated *only* when no image is apparent on the screen. In turn, this phototube operates a mechanical apparatus which quickly rejects the bad beam. At all other times—presence of an image on the screen prevents the third phototube from operating.

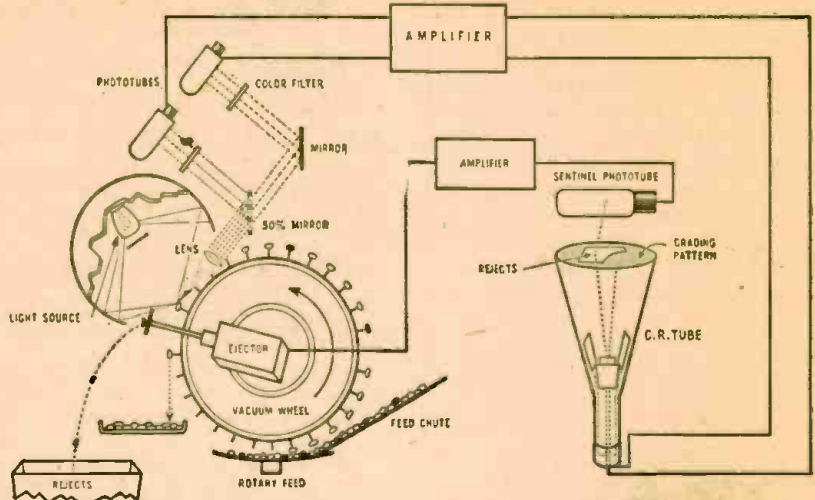

Fig. 6—Simplified diagram of the RCA electronic bean sorter, showing phototube mechanism.

"CHURCHILKA" BEAT NAZIS

(Continued from page 53)

from British, American, French, and Soviet short-wave broadcast stations.

These supplementary inductors, similar to standard short-wave inductors, masked in many ways and provided with convenient clips or connectors, have been called "churchilka" after Churchill.

The photographs will give you an idea of "churchilka" construction and what it looks like. It was a celebrated circuit, as the Czech people wished to be

well informed about all the events of the war. This invention rendered useless practically the whole German effort. The clever camouflage of some of these little instruments provides an interesting note on the resourcefulness of the Czech people, as well as their stubborn opposition to the dictates of the forces who occupied their country.

From a letter by M. Pacak, Chief Editor of *Radioamater* (Prahá, Czechoslovakia), referring to the photographs in *Radioamater* which are reproduced here.

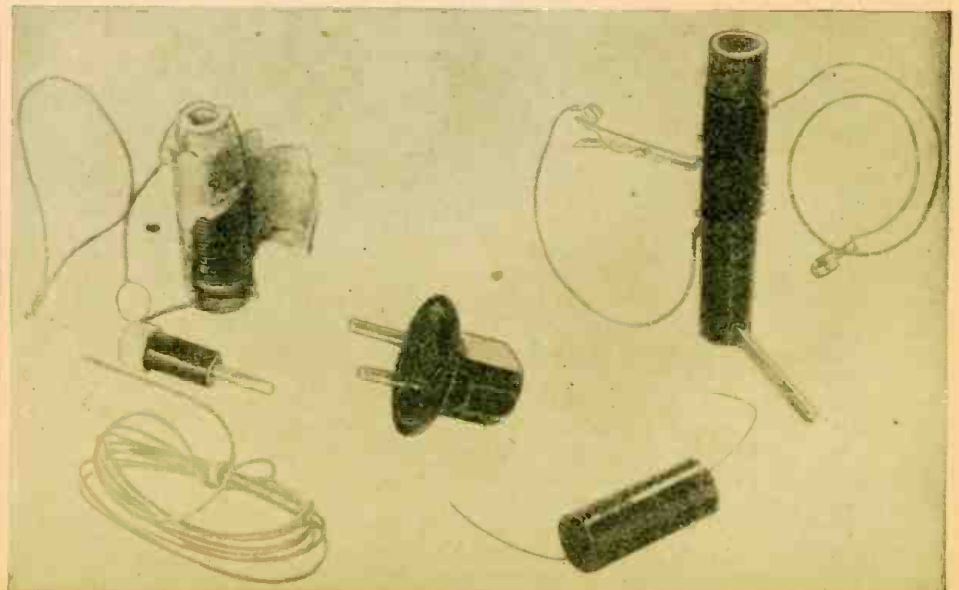

TIME DELAY CONTROL CIRCUITS

(Continued from page 27)

more R or C or both will be required for the 1-second delay. If the battery is smaller, less R and C will be necessary. Naturally, the total battery voltage must be not less than that required for plate current cutoff or reduction sufficient to open the relay.

Fig. 4 is a practical circuit for a timer for printing photographs. The battery B is between 7½ and 22½ volts, depending upon the current at which the plate relay opens. Actually almost any battery can be used, as there are compensating means, to be described. Power for the unit is obtained from the 117-volt a.c. or d.c. line, through the rectifier unit within the 117L7. (Other similar tubes or separate rectifier and control tubes can also be used.) In adjusting the unit, the tube grid is shorted to ground with the push button S and the tap on R1 adjusted for a plate current sufficient to close the relay, plus a little extra. The short is then removed and R set at maximum resistance. The tube is now biased to cut-off (assuming the battery voltage is sufficient) and the relay open. To operate, close the push button S and release it. The grid shorts to ground, the relay closes, and the light is lit, exposing the printing paper. Closing the relay disconnects the push button from the circuit, and the condenser C immediately begins charging.

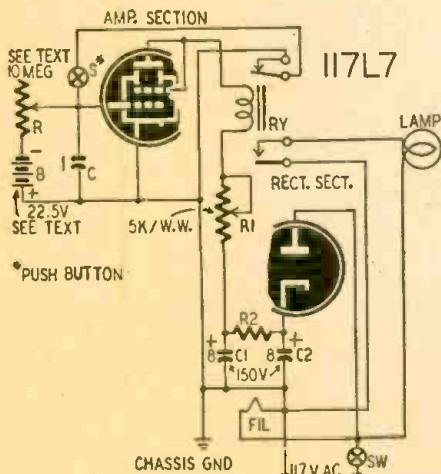

Fig. 4—Practical photograph printing timer.

After an interval of time determined by B, R, and C, the grid becomes sufficiently negative to cause plate current to drop and the relay opens, extinguishing the light. If the button is held down, the relay will immediately close again; so, in practice, the button should be released immediately. The values given for R and C in the diagram are convenient ones, but proper operation for almost any maximum time interval and with almost any battery can be obtained by changing these values. R is a simple potentiometer operated as a rheostat by omitting connections to one of the ends. For increased maximum delay, it may be made larger than 10 megohms or a resistor placed in series with it. Con-

Ready for you . . .

SURPRISE TRADE-IN ALLOWANCES

BY Walter Ashe



Trade in your used Receiver or Test Equipment. Take advantage of the extra liberal allowances offered by Walter Ashe. All the big name brands in stock ready for your selection. Phone, wire or write today.

BRAND NEW
Throat mikes, 200 ohm carbon.
In original boxes.. \$.35

BRAND NEW
T-17 hand mikes single button carbon, push to talk, in original boxes \$1.49

SPECIAL! SPECIAL! SPECIAL!

ICA 2 AND 3 GANG VARIABLE CONDENSERS
No. 534, 2 gang 350 MMFD per sec. \$2.59
No. 531, 3 gang 350 MMFD per sec. \$3.79

SOLAR POWER LINE FILTER

Rated 20 Amps 115 volts \$1.79

ARMY SURPLUS HEADPHONES

BRAND NEW Army surplus headphones, Type RS, 23, 8000 ohm imp. Complete with leather headband and rubber cushions in original boxes.. \$1.29

BRAND NEW ARMY SURPLUS KEY
Large Coin Silver Contacts, Bargain at \$.98

Action!

YOUR ORDER FILLED AND SHIPPED THE DAY IT IS RECEIVED!



HI POWER FOTO FLASH KIT

THOROUGHLY PROVED AND TESTED

1. Uses AMGLOW 54R4X 200 watt second flash tube.
 2. Uses parallel bank condensers. 25% safety factor. No costly replacements.
 3. Synchronizer adjustment control.
 4. Light weight, Heavy Duty, Army Surplus, High Voltage transformer.
 5. Unit can be fired every 3 seconds if necessary.
 6. Neon bulb charge indicator.
 7. 1/10,000 second exposure.
 8. Triggered by hand switch or synchronizer.
 9. Sockets for connecting all cables.
- Complete Kit including AMGLOW tube, carrying case, etc., with simple assembly and operating instructions.

\$77.50

Price subject to change without notice
Write for detailed description and parts list.

IS YOUR NAME ON OUR MAILING LIST?

W6JWD W6WTM W6PGI
W6ULH W6NRF W6QDF
W6IYD

Walter Ashe RADIO CO.
1125 PINE ST. • ST. LOUIS, MO.

denser C may also be increased in size, but values larger than 1 microfarad may be harder to find. CAUTION: Do not use electrolytic condensers in time-constant circuits. They have a comparatively small d.c. resistance and will destroy the efficiency of the circuit as well

as drain the battery. Values of C, B, and R should be determined experimentally, and can be varied to give any desired time delay.

This same circuit can be used to control an amateur radio station. The plate, relay in this case, is used to transfer the antenna from transmitter to receiver and to open the plate voltage circuit of the receiver, as shown in Fig. 5. An extra set of contacts (not shown) can control the transmitter high voltage. Filament and plate voltage for the control tube can be conveniently taken from the transmitter in which it is mounted. Any triode or triode-connected pentode is satisfactory, if its plate current will operate the relay. When the key is first

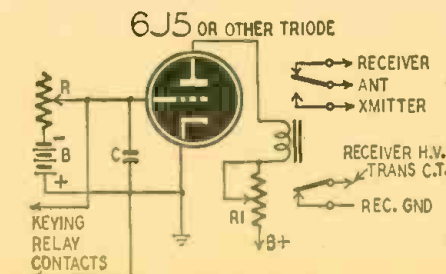

Fig. 5—Remote control for ham radio station.

(Continued on page 62)

GOVERNMENT SURPLUS

We have on hand a large selection of Radio and Electronic Equipment purchased from the United States Government, and solicit your inquiry on practically any equipment or component parts used by the Army or Navy. Listed below are only a few of the many items we now have in stock.

- Indicator I-921A. Uses Selsyn with indicating rose, 100 2H power tube, assorted breakers, high voltage condensers, etc. Good for antenna and transmitter control and remote modulator. Basic kit, 110 V 60 cyc. \$27.50
- Scope, 5" 110 V 60 cycle input. Control unit LC-1266. 15 Tubes including 5 CPl. Has all power sup lics built in except for 300 Volt amp. B voltage 40.00
- SAVE EIGHT DOLLARS! Purchase both of the preceding items, packed in original shipping case and crate. Shipping Wgt. 400 lbs. 59.50
- Jeweled lamp assembly, 1" panel mount. Drake type 7529
- Message Holder, excellent for station logs, regular letter size 8 1/2 x 11" with extra clip for holding spare sheets, also protective cover. Reg. Signal Corps. type95
- Spark Plug suppressors—6 for35
Box of 50 2.25
- Electrolytics, 10 x 10 x 10 x 10 @ 400 V Mallory FP—can89
- Dynamotors for RC 191 BC 375 Transmitters. 14 V DC input to 1000 V DC output @ 350 MA. GE-BD-77 9.75
- Neon Bulbs, GE 1/4W 115 V Rayonet base \$15 each 1.15
- Neon Bulbs, GE 1/4W 115 V Candelabra base \$17 each 1.25
- Test clip. Frankel. Insulation piercing type. 12 for59
- RGB/U Coax. 52 Ohm. Per foot 50" and over—Per Foot07
- Fiberglass tape. 1" x .015" Excellent insulation. 36 yd. roll35
- Empire cloth. .015" thick Westinghouse Tuffernell, sq. yd.65
- Kit of 100 1/2 Watt Resistors. Assorted 2.49
- Relay, 24 Volt, 60 Cycle Coil. Contact 15 Amp DPST. Normally Open. Ward Leonard 1.95
- Relay, 2.5 V or 5 V Coil. 60 Cycle. Contacts 150 Watt. Guardian Elec. 1.25
- 2 Amp. 3 AG. Littelfuse. 10 for25
- Whip Antenna, 3 removable sections to make 9 ft. Whip W/insulated Mast Base MP-22-A Constructed to swivel when hit by obstruction. Excellent for Mobile Antenna 5.50
- Linsman's pole climbers 4.50
- Safety belt with strap. State belt size wanted 5.75
- Terminal strips. Molded bakelite 16 screw terminals. 8 circuits. 5 1/2" long x 2" wide. Barriers between terminals. Mfg. GE19
Lots of 2012
- 45 V Heavy Duty "B" Batteries 8 x 4 1/2 x 7 1/2. Date of Mfg. May 1945. Carton of 4 1.98
Lots of 10035
- 6 V Lantern Battery. 2 1/2 x 2 1/2 x 3 1/2. Date of Mfg. June 1945. Box of 598
Lots of 10015
- Choke 3.8H @ 105 MA DC. Unceased but tropicalized39
- Heater Strip 230 V. 200 Watt Chromalox type PT 702. Screw terminals. 7" strip60
- Cartridge heater 115 V 25 Watt. Immersion type 10" long x 1/2" round case. With asbestos covered 10" leads. Chromalox type C 204.50
- IF Amplifier. 4 Stage. 36 Mc. 1.4 mce. wide. 7 Tubes — 4-6AC7; 1-6BJ7; and 2-9002. Shipped with tubes and complete set of spare parts. Including extra set of tubes. Shipping Wgt. 40 lbs. 19.50
- BC-375 100 Watt Transmitter for A1, A2, and A3 emission covering 200-500 KC and 1.5-12.5 MC by means of seven plug-in tuning units. The power amplifier is a neutralized class "C" stage using 211 tubes and is equipped with an antenna coupling circuit. Supplied complete with all components, including 28 VDC Dynamotor necessary for an operating installation 44.50
- SCR-274-N Command Set consisting of three receivers covering (100-550 KC) (9.0-6.0 MC) (6.0-9.1 MC) and two transmitters covering (4.0-5.9 MC) (5.3-7 MC) plus all equipment including modulator unit and 24 VDC Dynamotors to complete an operating installation. Easily converted to 110 volt 60 cycle operation 39.95

ABOVE PRICES F. O. B. BALTIMORE
MINIMUM ORDER \$2.00

The Abell Distributing Company

5 E. Biddle St. Baltimore 2, Md.

Send for Our Flyers
Name Items Interested in

TIME DELAY CONTROL CIRCUITS

(Continued from page 61)

pressed, control tube bias falls to zero, closing the relay. This disables the receiver and connects the antenna to the transmitter. The resistance R is adjusted so that, in normal keying, during the period the key is up (between characters) the grid will not have time to become negative enough to open the plate relay. But when transmission is completed, or when it is broken briefly, the receiver automatically will become operative. This gives control of the entire station with the key and eliminates the terrific thumping which occurs during break-in operation when the receiver high voltage is keyed directly with the transmitter. If R is adjusted for a

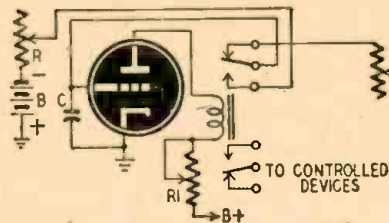

Fig. 6—Double-control reciprocating circuit.

short delay (1 second or so), virtual break-in operation is achieved.

The circuit of Fig. 4 may be used exactly as is where a light-blinker system is desired, such as an advertising sign. The only change necessary is to make S a toggle switch.

Fig. 4 is a reciprocating circuit when a toggle switch is used; that is, the relay will open and shut automatically until the switch is opened. However, in Fig. 5, there is no control over the period when the relay is open. This period is very short. A reciprocating circuit can be substituted easily to give full control over the time during which the relay is open as well as when it is closed. This is shown in Fig. 6. When power is first applied to the tube, the grid is grounded through R2, giving it zero bias and energizing the relay. This connects the grid to the battery, through R. When the condenser charges and finally allows the battery voltage to appear across the grid, the tube is cut off, opening the relay. The condenser is now shorted by R2, and must discharge through it. As explained in the first part of this article, the discharge process is the exact reverse of the charging. A certain time will be required for condenser voltage to reach zero, determined by the value of R2. When this happens, the relay shuts again and the whole process is repeated. R is adjusted to determine the time during which the relay is open. The two periods are independent and may be similar or widely different. As with all the circuits described the variable resistors (potentiometers) can be placed on the panel of the instrument with a pointer knob and scale calibrated in seconds. The extra contacts on the plate relay in Fig. 6 are used to control the actuated device.

HARD-TO-GET PARTS

POWERFUL ALL-PURPOSE INDUCTION MOTOR

IDEAL FOR EXPERIMENTERS—101 USES



Sturdily constructed to precision standards, this self-starting shaded pole A.C. induction motor is powerful enough for a number of uses. Some of these are: Automatic Timing Devices, Current Interrupters, Electric Fans, Electric Chimes, Window Displays, Photocell Control Devices, Electric Vibrators, Small Grinders, Buffers and Polishers, Miniature Pumps, Mechanical Models, Sirens, and other applications.

Consumes about 15 watts of power and has a speed of 3,000 r.p.m. When geared down, this sturdy unit will constantly operate an 18-inch turntable loaded

with 200 lbs. dead weight. **WATT'S POWER!**
Dimensions 3" high by 2" wide by 1 1/4" deep; has 4 convenient mounting studs; shaft is 7/16" long by 3/16" diameter, and runs on self-aligning oil-retaining bearings. Designed for 110-220 volts, 50-60 cycles, A.C. only. Shp. Wt. 1 lb.
ITEM NO. 87
YOUR PRICE \$2.95

ULTRA MAGNET

LIFTS MORE THAN 20 TIMES ITS OWN WEIGHT

LITTLE GIANT MAGNET

Lifts 5 lbs. easily. Weighs 4 oz. Made of ALNICO new high-magnetic steel. Complete with keyhole supply. Most powerful magnet ever made. The experimenter and hobbyist will find hundreds of excellent uses for this high quality permanent magnet. Measures 1 1/4" x 1 1/2". Shp. Wt. 3 lbs.
ITEM NO. 159
YOUR PRICE \$1.50



GENUINE MICROPHONE TRANSMITTERS



Regular telephone transmitters taken from a large telephone supply company's overstock. Work perfectly on 2 dry cells. Can be used on F.A. systems, call systems, intercommunications, etc. Also, short-line telephone circuits, house-to-house or farm-to-farm phone lines, also to talk through your own radio or as concealed dictaphone pick-up. Useful replacements on battery-operated rural telephone lines.

THESE ARE GENUINE TRANSMITTERS, MADE BY KELLCOG, WESTERN ELECTRIC AND STROMBERG-CARLSON, excellent in appearance and operation. A remarkable value and one seldom offered in these times. Shp. Wt. 1 lb.
ITEM NO. 160
YOUR PRICE \$2.10

AMAZING BLACK LIGHT!!

Powerful 250 Watt Ultra-Violet Source



The best and most practical source of ultra-violet light for general experimental and entertainment use. Makes all fluorescent substances brilliantly luminescent. No transformers of any kind needed. Fits any standard lamp socket. Brings out beautiful opalescent hues in various types of materials. Swell for amateur parties, plays, etc. to obtain unique lighting effects. Shp. Wt. 2 lbs.
ITEM NO. 87
YOUR PRICE \$1.95

WESTERN ELECTRIC BREAST MIKE

This is a fine light-weight aircraft carbon microphone. It weighs only 1 lb.

Mike comes with breastplate mounting and has 2-way swivel adjustment so that it can be adjusted to any desired position. There are 2 woven straps; one goes around neck, the other around chest. Straps can be snapped on and off quickly by an incontinent arrangement.

This excellent mike can be adapted for home broadcasting or private communication systems. By dismantling breastplate, it can be used as desk mike.

Comes complete with 6-foot cord and hard rubber plug. Finished in stainless steel.

ITEM 152
YOUR PRICE \$1.49



WATTHOUR METER

Completely overhauled and ready for immediate service. Designed for regular 110-volt 60 cycle 2-wire A.C. circuit. Simple to install; 2 wires from the line and 2 wires to the load. Sturdily constructed in heavy metal case. 8 1/2" high, 6 1/2" wide, 5" deep. Westinghouse, G. E. Ft. Wayne, Sankamo or other available make. Shp. Wt. 14 lbs.

ITEM NO. 33
YOUR PRICE \$6.95



HUDSON SPECIALTIES CO.

40 West Broadway, Dept. RC-8-47, New York 7, N. Y.

I have circled below the numbers of the items I'm ordering. My full remittance of \$ (include shipping charges) is enclosed (NO C.O.D. ORDERS UNLESS ACCOMPANIED WITH A DEPOSIT.)

OR my deposit of \$ (is enclosed (20% required), ship order C.O.D. for balance. NO C.O.D. ORDER FOR LESS THAN \$5.00. BE SURE TO INCLUDE SHIPPING CHARGES.

Circle item No. wanted:

147 159 160 87 152 33

Name

Address

City

State

Please Print Clearly

**DEALER SERVICE BUILDS
VOLUME**

(Continued from page 30)

bought from several tube and part manufacturers at small cost.

The wholesale price on repair jobs can be figured by deducting from a fair, regular retail charge (approximately 20% on small jobs to about 10% on large, expensive ones). The merchant can charge a retail price suggested by the serviceman or he may choose to make his own markups. After each month's collections have been made, a statement is given the store showing any outstanding invoices that may not have been paid.

There are advantages to the serviceman as well in an association of this kind. If radio tubes are stocked and sold by the retail store, as in this instance, it is not necessary for the serviceman to carry a stock of tubes in his shop. A fair plan is for the serviceman to buy all his tubes from the retail store at the "one-to-five" wholesale price; the store will buy them in large quantities and take advantage of the larger discounts and will still make a little profit from the tubes sold to the serviceman. The advantage in this is the eliminating of the large overhead a tube stock entails. One or two tubes of popular types can be kept at the service bench and others procured as needed.

Special arrangements

A setup has been worked out by the writer with one store in which he does all the repair work and service calls without charge to the merchant on radios sold by the store. The store in turn pays for the ads run each week in the local newspaper. Other similar trades can be worked out.

The store used as an example is a tire and supply company which has arrangements for servicing cars for tires and accessories. This works out very nicely for taking care of car radios. The store makes its own charge for taking out and installing car radios, and the serviceman is presented with car radio work without the usual encumbrances. This store also sells and installs car aeriels and the proprietor is capable of minor trouble-shooting on bad aeriels, loose connections, blown fuses, poor lead-ins, and the headaches of static suppressors and condensers. This eliminates a lot of wasted time and leaves more of that precious part time for the more profitable bench work.

Under this plan the service shop in the home can be small since there need not be the usual clutter of uncalled-for radios and the normal accumulation of "junkers" laying around.

Since wholesaling narrows the margin a little on each repair job, careful thought must be given to overhead, buying, and stocking of parts and the investment in test equipment; only small stocks should be carried. Small orders for parts, placed as needed, will eliminate large expense items. By using this method the volume of repair work each

**SERVICE & SOUND ENGINEERS
ATTENTION!
HERE IS A REAL BUY-**

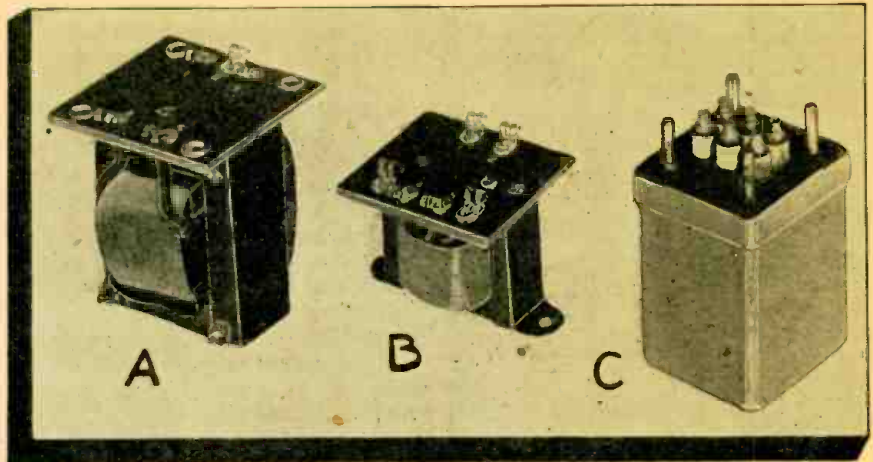

- **A** #43008 Heavy duty output transformer, 25 watt.
 Primary: Push-pull or single tubes—6L6, 6F6, etc.
 Secondary: 4-6 ohm voice coil.
 Approx. list price \$6.00 Our price 50^c
 12 or more . . 45c ea.
- **B** #43009 Heavy duty input transformer.
 Single tube to push-pull grids.
 Split secondary.
 Approx. list price \$4.00 Our price 25^c
 12 or more . . 20c ea.
- **C** #43010 Low impedance input transformer.
 Primary: 30-50 ohms.
 Secondary: 180,000 ohms.
 Ideal for low impedance mike lines, phonó lines, etc.
 Approx. list price \$28.00 Our price 75^c
 12 or more . . 70c ea.

ALL TRANSFORMERS BRAND NEW—JAN INSPECTED & GUARANTEED

20% Deposit with orders. All prices FOB Buffalo
 SPECIAL ATTENTION TO MAIL ORDERS

**Complete line of
 Parts, Tubes, Test Equipment and Batteries
 WRITE FOR PRICES**

STANDARD ELECTRONICS DISTRIBUTING CO., INC.
 1497 MAIN ST., BUFFALO 8, N. Y. GA. 5000

month will control the outlay for parts and will stay in line even during a slow period. If you are in an outlying territory, some such setup as described above with a tube dealer will assist in keeping your stock to a minimum. Although cutting the overhead to the bone is being stressed, common sense will keep you from being handicapped by not having an ample stock of common items.

Test equipment and tools need not be elaborate but must be adequate. A vacuum-tube volt-ohm-milliammeter, or a good a.c.-d.c. multimeter, a signal generator, and a tube tester are the necessary basic items. An inexpensive signal tracer is very valuable. Another tool, and one that can be made by the serv-

iceman, is a handy shunt box. This box should contain electrolytic condensers, or combinations of condensers, to make all the values commonly encountered in receivers, a complete range of paper condensers from about 0.5 µf to 0.001 µf and a potentiometer of about 1 megohm resistance. These can be arranged by switching or by plugging in test leads. This test box is a great help and will save much time in service work. Several circuits have appeared in RADIO-CRAFT in recent months covering the construction of these shunt boxes.

With only the above basic pieces of equipment, and by following the plan outlined, the writer has been very successful in part-time radio servicing.



Lite-Koat — Cable Kit —

Ne-O-Lite Tester • Cement

G-C LITE-KOAT KIT

"Glow in the dark" Luminous safe coating—Emits light in dark. For office, home, etc. No. 184-0—Do-Luxe Kit List \$2.50



G-C SERVICEMEN'S DIAL CABLE NO. 1

Contains four 25 ft. spools of popular dial cable with free assortment of eyelets and clamps. No. 77-5K List \$4.76

G-C NE-O-LITE TESTER

Handy, inexpensive; a tester that everyone needs for countless uses. Can be used on 60 V.A.C. to 500 V.A.C. or D.C. No. 5100—single tester on card. List 50c
Displays of 12 or 20 available.



G-C BAKE-LITE CEMENT

Prepared for cementing Bakelite to Bakelite or Bakelite to other materials. Useful for broken knobs, molded cabinets, etc. 12 to display. No. 32-2—2 oz. bottle List 55c
G-C Products are available at leading distributors

Send for the new G-C 147 and Hardware Catalog of over 4000 items.

RADIO DIVISION DEPT. D

GENERAL CEMENT Mfg. Co., Rockford, Ill., U. S. A.
Manufacturers of over 3000 products
Sales offices in principal cities

QUIK-LABELS CODE CARD SYSTEM

Removable Self-Starters Strip exposes ends of Labels for you to peel!

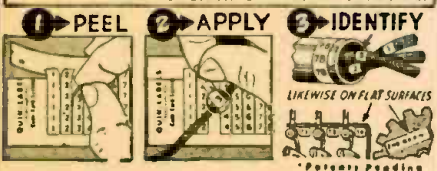

QUIK-LABELS

Make Money for YOU

QUIK-LABELS mark Wires, Circuits, Leads, etc. faster and cheaper. • Precut to exact size, QUIK-LABELS come in rows on handy cards, stick without moistening. • Replace slow and costly string tags, metal tabs, etc. • Marking wires at time of disassembly speeds up reassembly, helps you make many MORE REPAIRS IN A DAY. • Also brings you a better price for your work when customers see you have marked and reconnected wires just like at the factory. • These handy labels fit in pocket or tool kit. • 500 different radio & electronic symbols in stock. • Send us this ad attached to your letterhead for Folder and FREE Sample Cards.

W. H. BRADY COMPANY
Identification Specialists
Established 1914

802 N. Third Street, Milwaukee 3, Wisconsin

PORTABLE RECORDER-PLAYER

(Continued from page 21)

sults in saving weight and space, highly desirable in a portable unit.

The radio-frequency tuner (Fig. 3) is completely conventional with a 6A8 oscillator-translator stage, a 6SK7 i.f. amplifier, and a 6SR7 diode detector and audio amplifier. The 6SR7 was chosen in favor of the more common 6SQ7 because the amplification factor of the triode section is lower, with no overloading as when the 6SQ7 is used.

Fig. 2 diagrams the connections of the control panel and the interconnection of the amplifier, r.f. tuner unit, turntable motor, and speaker to the control panel within the case. The rear side of the panel and the inside view are all illustrated.

The carrying case used is a conventional fabric-covered portable-changer case. The inside dimensions are as follows: width, 16 inches; length, 16 inches; depth of lower section, 5 inches; depth of upper section, 6 1/4 inches.

The panel and chassis are made of 1/16-inch aluminum stock. Both the amplifier and tuner chassis are simple U-shaped units, bent to a depth of 1 inch. The function of each of the con-

trols may be marked on the panel with a metal stamp lettering set and the letters filled in with enamel.

Dimension and suggested layout for the chassis and panel are shown in the photographs. Slight deviations in layout may be made, but the general layout should be followed. Note that the variable tuning condenser is mounted, not on the r.f. tuner chassis, but on the bottom of the case with its shaft protruding up through a hole in the panel. The dial arrangement consists of a shaft extension with a disk of celluloid at-

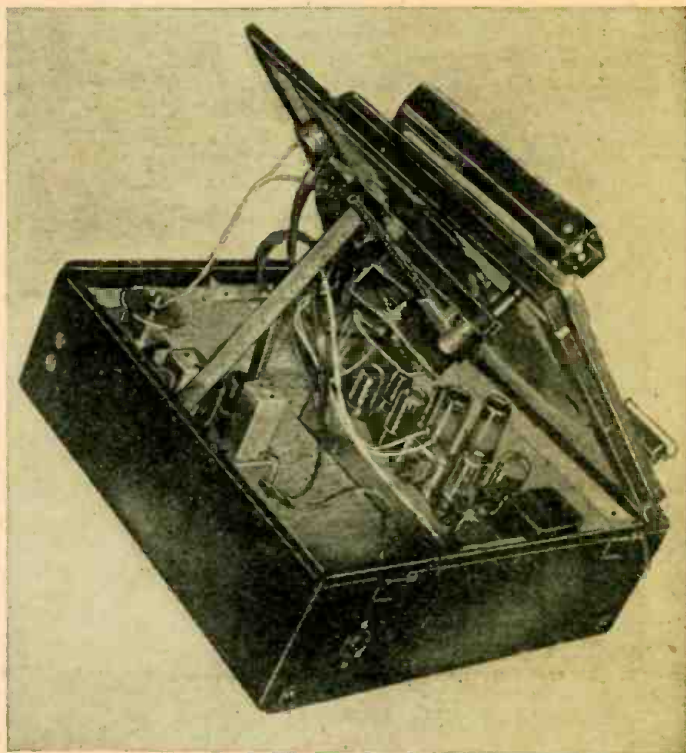

This view gives a good idea of how parts are placed in the case.

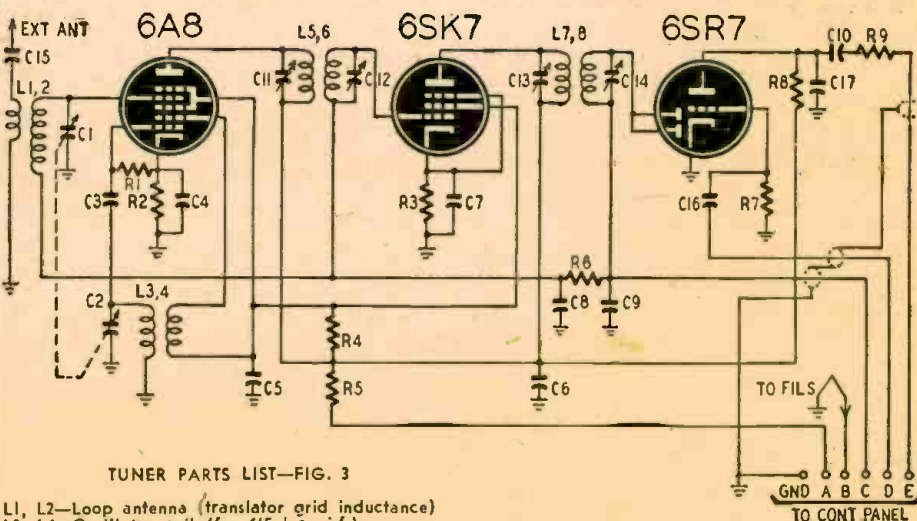

TUNER PARTS LIST—FIG. 3

- L1, L2—Loop antenna (translator grid inductance)
- L3, L4—Oscillator coil (for 465 k.c., i.f.)
- L5, L6, C11, C12—465-kc. i.f. transformer with trimmers
- L7, L8, C13, C14—465-kc. i.f. transformer with trimmers
- C1, C2—2-section variable condenser, oscillator and translator section with trimmers
- C3—50- μ f, mica condenser
- C4—0.03- μ f, 400-volt, tubular paper condenser
- C5, C6—0.1- μ f, 400-volt, tubular paper condenser
- C7, C8—0.05- μ f, 400-volt tubular paper condenser
- C9, C11—250- μ f, mica condenser

- C10—0.02- μ f, 400-volt, tubular paper condenser
- C12—0.01- μ f, 400-volt, tubular paper condenser
- R1—50,000-ohm, 1/3-watt, carbon resistor
- R2—130-ohm, 1/3-watt, carbon resistor
- R3—300-ohm, 1/3-watt, carbon resistor
- R4—10,000-ohm, 1-watt, carbon resistor
- R5—5,000-ohm, 1-watt, carbon resistor
- R6—1-megohm, 1/3-watt, carbon resistor
- R7—5-megohm, 1/3-watt, carbon resistor
- R8—250,000-ohm, 1/3-watt, carbon resistor
- R9—500,000-ohm, 1/3-watt, carbon resistor

RED HOT SPECIAL!

Limited quantity for immediate shipment—
while they last

8,000 OHM DUAL HEADSET H-16/U

★MOST SENSITIVE
PHONES BUILT

★HI-IMPEDANCE

★NOISE PROOF

★MAY BE USED AS
A SOUND POW-
ERED INTERCOM



BEST IN YEARS BUY

Light, durable, and efficient phones featuring a permanent magnet with an 8000 ohm transformer built into each unit. Molded soft neoprene earcup shaped to snugly and comfortably envelop the entire ear. Steel headband with new type adjustable sliding brackets allow earcups to be extended or retracted. Cover plates constructed of lightweight magnesium. No removable parts to become loose or lost. Especially suited to hams and commercial operators, recording engineers, aircraft pilots and similar exacting applications. Hi-impedance, extremely sensitive. May be used as sound powered interphones without use of a battery. Can even be used with simple xtal to make a complete radio receiver.

ORIGINAL
COST—\$25.00

Priced at **\$2.49**

FLASH! NEW TRANSVISION 12" TELEVISION KIT.
Write for complete details and price.

NEW BC-728-A PORTABLE RECEIVER

•Police •Shortwave •Marine
•Telephone •75 Meter Ham Band
•Fire Department

- *Seven-Tube Superhet
- *Tunes from 2-6 mc
- *Operates on Wet or Dry Cell Batteries
- *Designed for 2-volt input from Self-Contained Wet Cell Battery which can be re-charged from 6 v. Battery
- *Can be easily padded for Broadcast Band with 300 MMFD Condensers.
- *Portable
- *Four Push Buttons
- *4" Speaker with Heavy Slug



Perfect Receiver for Field Day Use or for Emergency Receiving Equipment. Pick it up and carry it anywhere. Has one stage R.F. converter, one stage I.F. detector and A.V.C. pushbutton channel selector and two stages A.F. Uses all miniature low drain tubes. This Receiver is built to field Army specifications, and originally designed as emergency equipment to be carried in jeeps, it is rugged . . . dependable . . . durable . . . Limited quantity.

2-Volt Storage Battery to fit Compact Space Available . . . \$3.49

PRICED AT
Complete with Tubes, Power Supply (less battery) and battery charger.

\$12.95

20% deposit on all orders unless rated. We prepay freight on \$100 orders in U.S.A.

NIAGARA RADIO SUPPLY

160 GREENWICH ST., NEW YORK 6, N. Y.
Bowling Green 9-7993

All prices F. O. B. N.Y.C.
WRITE FOR LATEST BULLETIN 8RC

tached to the shoulder. This rotates beneath the panel and is viewed through the round window in the panel. The celluloid scale is made translucent by rubbing with steel wool or fine sandpaper.

The over-all layout may be studied from the photographs. The speaker is mounted toward one corner of the inside of the lid, so that with the lid closed it will clear the pickup arm and leave room for carrying a stack of 10-inch recording blanks. These are held on a ¼-inch, 20 screw, through the lid, with a washer and a wingnut. The microphone and stand are held rigidly in

place in notched wood blocks, secured to the side of the lid by 2 small wooden cleats. A ¼-inch, 20 screw is attached to each block, and a wing nut is tightened down on the cleat. Another small block is attached to the side of the lid to prevent the pickup arm from falling off its stand when the unit is carried.

The speaker line, a.c. cord, and a 20-foot microphone cable are carried coiled within the lid to complete the unit. The auxiliary turntable, previously referred to for re-recording, can be any dual-speed turntable with a crystal pickup in a portable case.

TRAVELLERS' 2-TUBER

(Continued from page 37)

full advantage is taken of them, it is estimated that the volume occupied by the set can be cut down about 30%.

Alignment is simple. The trimmer condensers mounted on the variable condenser are merely adjusted for maximum volume on a local station. Some compromise may have to be made to equalize the volume obtained over the whole dial. Mounting one of the coils on top of the chassis and the other at right angles underneath will help prevent squealing. Making the r.f. plate and grid leads as short as possible will have the same effect.

As an antenna the author is now using about 20 feet of insulated wire, after having tried bed springs and window screens with equally good results. The use of an over-long antenna

is neither necessary nor advisable where there are powerful local stations, as selectivity becomes bad. A 400-foot antenna tried out in Hawaii provided loud-speaker reception from stations as far away as Fort Worth, Texas, but selectivity on local stations was poor.

The cabinet measuring 6x5x3½ inches is just large enough to house the chassis. Made of quarter-inch plywood nailed and glued together, it was shellacked and then varnished, giving a blond natural finish. If proper tools are not available, a sharp knife is useful in cutting out the speaker grill without splitting the work.

Cost will vary with the type of parts selected. Buying everything at somewhat inflated Honolulu prices the set cost \$12.80.

RADIO PARTS SOUND SYSTEMS ELECTRONIC APPARATUS

★ Depend on
RADOLEK ★

Radolek's big Free Profit Guide Catalog and Profit Bulletin supplements keep you abreast of the rapidly changing radio situation. Buying from Radolek means greater values, better service and more profits. Make Radolek your buying headquarters.



FREE
CATALOG

Large Stocks
Fast Service

SEND TODAY!

RADOLEK CO., Dept. C-138
601 W. Randolph St., Chicago 6, Ill.
Please send your FREE Profit Guide Catalog.

Name
Address

SAVE AT RADOLEK

ELECTRONIC VOLT-OHMMETER
\$11.85
 110 VOLTS AC 20 RANGES
 0.5/10/50/100/500/1000/5000
 volts DC and AC. 0-1,000,000,000
 ohms in six overlapping ranges. Sensi-
 tivity: over MILLION OHMS per
 VOLT on 5 volt range.

PDSTPAID
 Complete kit includes all component parts, tubes,
 punched and drilled chassis and beautifully ena-
 melled panel. Easily assembled and wired.

Spectral slideback circuit developed during war
 by scientist at the California Institute of Technol-
 ogy gives amazing sensitivity and flexibility while
 completely eliminating necessity of batteries and ex-
 pensive meter. Each instrument is individually cali-
 brated. Dial scale over nine inches long!

In addition to performing the usual volt-ohm
 functions, this instrument easily measures these
 voltages: SUPERHET OSCILLATOR, AVC, AFC,
 TRUE GRID BIAS AT THE GRID, BIAS CELLS with-
 out affecting the circuit. Measures the exact leak-
 age resistance of INSULATION, TUBES, CON-
 DENSERS. It can be used with a signal generator
 for SIGNAL TRACING.

STERLING ELECTRONIC COMPANY
 166 N. Sierra Bonita Ave., Dept. 2, Pasadena 4, Calif.

**BUILD YOUR OWN Battery Driven
 ELECTRIC LAWN MOWER.** PLANS ONLY
35¢ WRITE TODAY

This ultra-modern rotary-blade mower
 can be made from inexpensive
 parts and an old auto gener-
 ator. Plans complete,
 easily followed. Mower
 cuts forward, backward, tall or
 short grass, weeds.

LOJAY MFG. CO.
 856 Le Jay Bldg.
 Minneapolis 8, Minn.

**Don't forget
 to refer to the
 RADIONIC
 Catalog!**

... BECAUSE IT'S ONE
 COMPLETE COMPREHENSIVE
 RELIABLE VOLUME

PARTS AND ACCESSORIES • TEST INSTRUMENTS
 • RADIOS • TELEVISION COMPONENTS • INTER-
 COMMUNICATORS • RECORDERS • PUBLIC ADDRESS
 • TUBES • HARDWARE • RECORD CHANGERS • TECH-
 NICAL BOOKS

Chancellor Radio

**RADIONIC
 EQUIPMENT COMPANY**

TRIBUNE THEATRE ENTRANCE
 DEPT. 108 170 NASSAU ST., N. Y. 7, N. Y. WOrth 2-0421
 CABLE "CHANSOR"

Radionic Equipment Co., Dept. 108
 170 Nassau Street
 New York 7, N. Y.

Please send me a FREE copy of your 1947 Catalog.
 I understand it has thousands of items illustrated,
 described and priced and will be a great help to me in
 my search for "hard-to-find" radio equipment. CHAN-
 CELLOR Portable and Phono Radios.

Name
 Address
 City State

MAIL TODAY

SPEAKER REPAIRS

This method for recentering voice
 coils on small PM speakers. With the
 set tuned to a station, grip the magnet
 with a pair of pliers and move it gently
 until reproduction is clear. After the
 coil is correctly centered, apply speaker
 cement liberally to the edges of the mag-
 net where it contacts the frame.

R. A. JOHNSON,
 San Antonio, Texas

ULTRASONIC PRINCIPLES AND CIRCUITS
 (Continued from page 34)

sound-cell type can be used, but, for the
 highest frequencies, a resonating quartz
 crystal is required. Any of the usual
 generating devices can also be employed
 —the iron core of an electromagnet will
 act as a detector, the vibration of the
 iron core producing a very minute volt-
 age across the winding. Condenser
 microphones with very thin solid die-
 lectrics (usually mica) have been
 employed. Even an ordinary telephone
 earpiece can be used as a detector
 —though it is not very sensitive—by
 brazing a brass rod to the diaphragm
 and putting the other end in the field of
 the vibration.

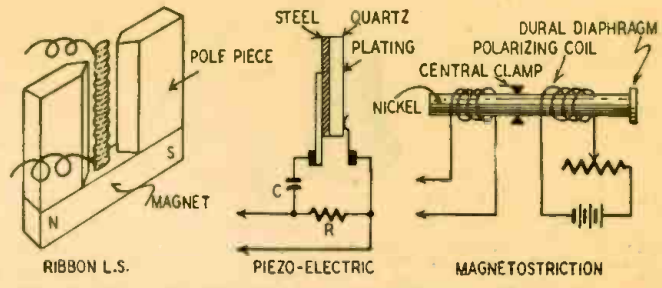

Fig. 4—Types of detectors and generators for ultrasonic waves.

After detection by the microphone,
 the high-frequency alternating voltage
 is amplified and made to actuate a meter
 or oscilloscope.

Ultrasonics in television

Ultrasonic vibration has been used
 in a television system that does not em-
 ploy a cathode-ray tube. The intensity
 of the lighted spot on the screen can be
 varied by a shutter vibrating at an
 ultrasonic rate or by varying the refrac-
 tive index of the air between the light
 source and the screen. (When air is in
 compression, its refractive index is
 changed and rays of light are brought
 to a focus at a different place.) See
 Fig. 5. Circuits of this type may become
 very important, as they operate on the
 principle of modulating a beam of light
 from a local source, and could thus con-
 ceivably result in much brighter and
 larger-screen television than would be
 possible with cathode-ray tubes.

A mirror vibrating at a rate near the
 limit of audibility can be used to pro-
 duce the high-speed scanning.

Further applications

Ultrasonic vibration has other uses
 as well. It is employed in testing metal
 objects, the conductance of ultrasonics
 being decreased by cracks, porosity, or
 blowholes. Ultrasonic vibration has both

the purification of air in factories.
 When ultrasonic vibration is applied
 to a vessel containing oil and water, or
 mercury and water, the intensely rapid
 vibration causes the two liquids to be
 agitated together so much that an emul-
 sion is produced. Maybe the housewife

could use it for beating eggs or for mak-
 ing cream. Because ultrasonic "sound"
 travels practically in a straight line, it
 can be used for signaling. The reflection
 of a beam by sea bottom or by a sub-
 marine finds its application in naviga-
 tion and in war, and was very important
 in detection devices used against Nazi
 and Jap submarines.

Acousti-chemical effect

Chemical reactions of some types are
 promoted by agitation, and these reac-
 tions are speeded up considerably by
 applying ultrasonic vibration. Some bio-
 logical processes (because they are
 chemical reactions) also can be in-
 creased in rapidity by ultrasound. Plant
 growth has been stimulated. On the
 other hand, certain types of insects have
 been destroyed. Ultrasonic vibration
 certainly appears to have a future,
 whether as a television device, metal
 tester, fog killer, depth finder, egg beat-
 er, lawn grower, flea killer, and, high-
 fidelity enthusiasts, don't forget that
 the theory of ultrasound is applicable to
 that high-note response you are always
 trying to achieve.

For the experimenter

Really startling results can be ob-
 tained by the application of from 50 to
 200 watts to a highly efficient generator
 such as a crystal or nickel rod working
 at its resonant frequency, but even a

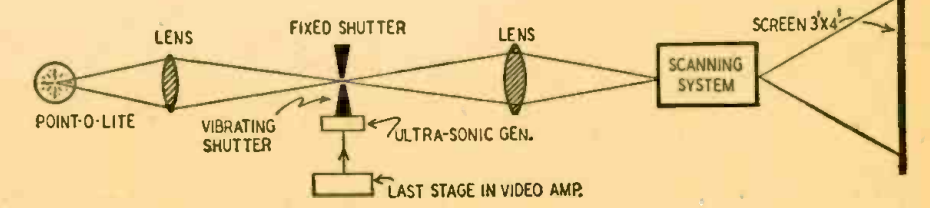

Fig. 5—Proposed television system in which a beam of light is modulated by ultrasonics.

coagulative and dispersive properties,
 depending on frequency and medium.
 Smoke particles in air can be coagulated
 by passing a beam of very intense ultra-
 sound through the air. Possibly this
 method will be used in the future for

mere 25 to 30 watts can be used in a
 small-diaphragm projector-type unit.
 Some people can sense high intensity
 sound of frequencies from 15 to 20 kilo-
 cycles without actually being conscious
 of any sound.

VOLUME EXPANDER

After trying several conventional automatic volume expander circuits using 6L7 tubes (they are invariably microphonic), I was dissatisfied with the results.

Combining the best features of several circuits, I developed a hybrid circuit that has given me good results.

In this circuit, the audio signal from the radio, or from a phonograph pick-up, is applied simultaneously to the grid of the first a.f. amplifier and to the grid of the 6SJ7 expander-amplifier.

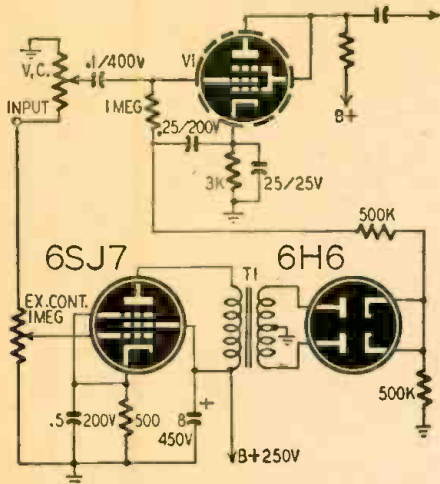

Schematic of the circuit. The top tube is incorrectly drawn and is actually a 6S7-G with suppressor and screen tied to the plate.

This tube amplifies the signal and couples it to the 6H6 expander-rectifier. The coupling transformer T1 is designed to couple the plate of a 24-A to push-pull grids; however, any transformer designed to work from a high-impedance plate, such as the Stancor A-2132 or Thordarson 57A42, may be used. The 6H6 is connected as a full-wave rectifier. The rectified voltage appears across a 500,000-ohm load resistor which is in series with the grid return of the first a.f. amplifier stage. The voltage across this resistor is positive, with respect to ground, and will reduce the effective bias on the grid of the tube. Since the rectified voltage is proportional to the amplitude of the audio input signal, the volume will increase with loud passages. The comparatively small capacity (0.25- μ f) connected between the ground end of the grid resistor and the cathode of the first a.f. stage gives almost negligible time delay, and therefore the expander will take hold and release rapidly to give lifelike reproduction.

This expander requires about 2 volts for efficient operation. If necessary, an additional amplifier stage may be connected between the 6SJ7 and the 6H6.

In adding expanders to any amplifier or radio, satisfactory results will be obtained only if the power amplifier stage is able to reproduce the loudest passage without distortion.

JOHN KWIETINSKAS,
Duquesne, Penna.

(The sensitivity of the expander may be controlled by replacing the 500,000-ohm rectifier load resistor with a potentiometer of the same value.—Editor)

A REAL POSTWAR INSTRUMENT MANUAL

One of the lesser effects of the war is the change in radio servicing instrument operators' manuals. The Army and Navy demanded complete and detailed instructions on every part and every use of the instruments issued to technicians whose training had often been brief and intensive.

An example of the peacetime effect of that policy is seen in a booklet just received, the *Simpson Operator's Manual* for their Model 260 volt-ohm-milliammeter. Containing 31 pages, it is 5 x 7 inches in size and bound in a durable fiber cover, printed in bold, easy-to-read type, with clear illustrations.

Opening with a description of the in-

strument, instructions are given for each operation; then the functioning of the instrument in each of its uses is described in detail. Breakdown schematics are given, as well as a complete schematic diagram (there are 13 figures in the book).

A section on maintenance is also included, and there is a complete parts list. A final section is devoted to special uses of the instrument.

Such a manual effectively increases the value of an instrument to its owner, and it is expected that other manufacturers will also remember their war-learned lessons in designing manuals for use with their equipment.



OLSON RADIO WAREHOUSE, INC. AKRON 8, O.

Free Gifts

for Olson customers



MARLIN RIFLE
.22 Caliber



EASTMAN
KODAKS



BULOVA
Wrist Watch



REMINGTON
Electric Shaver

Why not buy your Radio Parts where you get a FREE BONUS? Here's just a few of the big selection of nationally known articles you can get free. Olson sends you a free "Pointer" for every dollar's worth of Parts you order, and you get your gifts by saving up Olson Pointers. No catch to it . . . no limit to the number of free gifts you can get. Start saving those Olson Pointers NOW!



Paste the coupon on a Postcard-

GET THIS FREE BARGAIN BOOK

This is our big new book of Olson Bargains, containing 60 pages of real money-saving values in Radio Parts, Sound and Testing Equipment. It also has a section of GIFT PREMIUMS you can get by saving Olson Pointers. Mail the coupon TODAY for this valuable Free Book!

OLSON RADIO WAREHOUSE, INC.

73 E. MILL ST., DEPT. 91, AKRON, OHIO

I want to get Olson's Free Gifts. Send me your new FREE Premium Book and Price Guide right away.

NAME _____

COMPANY _____

ADDRESS _____

CITY _____ STATE _____

TEACH YOURSELF Radio & Electronics



Magi-Klips KIT

Build 18 Experiments at Home—No Tools!

RADIO RECEIVER, HOME BROADCASTER, PHOTOELECTRIC RELAY, CODE PRACTICE OSCILLATOR, SIGNAL TRACER, REMOTE CONTROL RELAY, Phonograph Transmitter, Intercommunication Amplifier, Code Transmitter, Radio Frequency Oscillator, Telephone Line Amplifier, Electronic Switch, Phonograph Amplifier, Temperature Control Relay, Contact Detector, Electronic Metronome, Interval Timer (one-shot), Interval Timer (repeating).

With a Magi-Klips kit you cover the entire field of radio and electronic engineering theory quickly in your spare time. It's simple to arrange the components for each circuit. No soldering. No tedious wiring. Kit operates on 110 v. AC or DC and includes 35Z5 rectifier, 50L6 power amplifier, 12SL7, double triode, powerful 4" speaker-mike, plate relay, broadcast and SW coils, tuning condenser and generous supply of resistors, condensers, chokes, extra wire. Parts worth double the price of kit.

Kit's 48-page manual has complete instructions and diagrams easily followed by the beginner. Remember, you need no tools, except possibly a screwdriver, with a Magi-Klips electronic and radio experimenter's kit **\$29.75** complete

SCHOOLS—Magi-Klips KITS are excellent equipment for laboratory and classroom. Write for special discount.
DEALERS—Some territories open. Write for your trade discount.

DEER & TAYLOR COMPANY
Dept. C, 1360 Milvia St.
Berkeley 9, Calif.

Please ship Magi-Klips electronic kit (5).

I enclose \$.....

Please mail FREE booklet, "Electronics Made Easy."

Name

Street

City

F.M. KIT

This High Quality FM Kit
at Remarkable Low Price



Model FM-7 is a splendid, low-priced, self-contained table model Frequency Modulated Radio Receiver Kit complete with tubes, speaker and beautiful Bakelite cabinet.

The FM-7 has a frequency response of 86-110MC, can also be used as a **tuner** with a high quality amplifier. A phonojack is provided in the rear of the chassis with double pole, double throw switch control for feeding signal to either the radio speaker or to the phonojack. An additional jack for connecting extra loud speaker is included. The R.F. section of the kit is **pre-tuned** at the factory. This kit uses 2 I.F. Stages, 1 limiter stage and 1 discriminator. Miniature tubes used throughout.

Price of Model FM-7 complete as described

..... **\$29.95**

Other high quality kits available:

5-tube Superheterodyne, 1 band including bakelite cabinet

6-tube Superheterodyne, 2 band including bakelite cabinet

5-tube AC/DC Battery kit with leatherette case

Write for Catalog M

RADIO KITS COMPANY

120 Cedar Street, New York, N. Y.

250 WATT FM-AM TRANSMITTER

(Continued from page 28)

they are not shown as such in the schematic, the 6F6-G and TB-35 plate coils are Barker and Williamson band-switching turrets from which some of the coils have been removed. W3KPX does not operate on the 80-meter band; therefore the 6F6-G plate tank turret consists of coils for 80, 40, 20, and 10 meters. The TB-35 turret consists of coils for the 40-, 20-, and 10-meter bands.

The HK-54 final r.f. amplifier is conventional in every respect. The coil used in its plate circuit is a Johnson rotary-link plug-in type. The rotary link feature is very desirable as it is incorporated in the coil itself and not in the jack bar. The link coil can be adjusted for proper coupling on the bank in use when the transmitter is first tuned up; when returning to this band,

by putting it on the air as a c.w. transmitter.

Adjusting the AM section

The first step in the procedure of placing the transmitter on the air is, of course, to tune up the 6F6-G, TB-35, and HK-54 r.f. circuits with the FM removed. Assume that you desire to operate on the 10-meter band. (The tune-up procedure for the other bands is similar.)

The switch in the grid circuit of the 6F6-G is placed in its No. 2 or crystal position. For 10-meter operation, either a 40- or 20-meter crystal of proper frequency may be used. A 20-meter crystal is recommended, as only frequency *doubling* in the TB-35 plate circuit is required, resulting in better efficiency. The 6F6-G plate and TB-35 grid tank

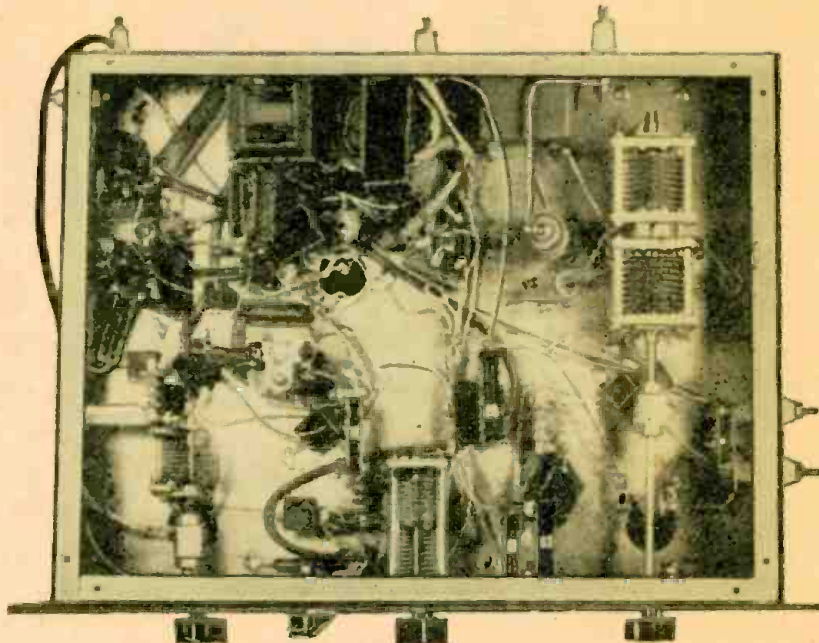

Under-chassis view of FM modulator and FM-AM r.f. section of the 250-watt transmitter.

it is *not* necessary to readjust the link coil as its setting is not disturbed when the coil is removed or reinserted.

The coil L1 consists of 31 turns of No. 22 d.s.c. close-wound on a 1 inch diameter coil form and tapped at a point 10 turns from the cold end. The filament winding T consists of 10 turns of No. 22, d.s.c. *parallel-wound* with turns of main winding between tap and cold end of coil. After coils are wound, paint the windings with low-loss coil dope to keep windings in place. L1 is wound on a plug-in form and is mounted under the round shield can near the large square can which houses the discriminator transformer.

The power supply will be considered in a future issue. However, the transmitter may be used with any power supply which will deliver 250 and 1,750 volts. The bias supply should deliver a maximum of 300 volts, and the grids should be biased to the manufacturer's specifications for c.w. operation. The main transmitter can then be checked

circuit is tuned to resonate at the crystal frequency. This circuit is tuned by adjusting the HRO-type dial at the extreme lower-right corner of the front panel. Resonance will be indicated by maximum grid-current reading from the TB-35 grid jack. The coupling capacitors and bias values are so chosen that the proper grid current in the TB-35 will be approximately 5 milliamperes.

If the excitation is supplied by an external variable-frequency oscillator, plate and screen voltage are removed from the 6F6-G. For 10-meter operation, it is recommended that the v.f.o. output be on 20 meters and of at least two or three watts power. The TB-35 grid turret, contains a built-in link at the cold end of each coil; the v.f.o.'s r.f. output is connected to the turret link terminals through a short length of RG-29-U co-axial cable. The grid circuit of the TB-35 is tuned to resonance in exactly the same manner as described above.

Up to this point we have not applied

plate voltage to the HK-54 or plate and screen voltages to the TB-35. The plate and screen voltages are now applied to the TB-35 and its plate circuit is tuned quickly to resonance. Using a calibrated wave meter, check the frequency to which the TB-35 plate tank is resonant. The TB-35 is a very good frequency-multiplier tube, and it is possible to obtain pronounced plate-current dips at frequencies far removed from the vicinity of the amateur bands. The cathode current to the TB-35 at resonance, with the voltage values indicated in Fig. 1, will be approximately 75 milliamperes. The grid current to the HK-54, with its plate voltage removed, will be about 25 milliamperes.

(Do not rotate the band switches with the plate voltage on the 6F6-G and the TB-35 tubes; to do so will cause arcing at the switch contacts and will burn away the silver plating.)

Neutralizing the final

The next step is to neutralize the final r.f. amplifier and apply plate voltage to the HK-54 tube. With the TB-35 plate circuit tuned to resonance on 10 meters, with 20 to 25 milliamperes of grid current supplied to the HK-54, and with HK-54 plate voltage removed, rotate the HK-54 plate tank tuning capacitor through resonance and watch the HK-54 grid milliammeter. Sharp fluctuation or "kick" in the grid current indicates that the plate circuit is being tuned through resonance. Adjust the neutralizing capacitor for minimum capacity, then slowly increase the capacitance until there is no change in the grid current as the plate tuning dial is rotated to any point on its scale. Adjustment of the neutralizing capacitor past this critical setting will again cause a change in grid current as the plate tank capacitor is rotated through resonance.

Once that neutralizing capacitor setting is found at which the plate tank tuning has no effect on the grid current, tighten the locking nut on the neutralizing capacitor and leave it alone. Apply plate voltage to the HK-54 and quickly tune the plate tank circuit for minimum plate current. The plate current to the HK-54, with a plate voltage of 2,000, will run from 150 to 200 milliamperes or higher when the plate tank circuit is tuned off resonance. Make the necessary adjustments as quickly as possible and do not allow the plate circuit to remain tuned off resonance. Without an antenna, the minimum plate current will be around 10 to 20 milliamperes when operating on 10 meters, and around 5 to 10 milliamperes when operating on the 20-, 40-, or 80-meter bands.

Before an antenna is attached to the transmitter, check, in the same manner as described above, to make certain that the HK-54 output circuit is tuned to a frequency in the 10-meter band. After it has been ascertained that the transmitter output is on the proper frequency band, attach the antenna coupling unit or the transmission line from the antenna to the final plate tank link ter-

NEWARK-HEADQUARTERS FOR VALUE

Amazing New 7" TELEVISION KIT

Again Newark shows the way! This fine 7" Telekit, at an amazing price, is easy to assemble from complete kit of parts, simple instructions. Guaranteed Performance! 17 tubes including 7" picture tube. Sound reception is high fidelity FM. Less tubes and cabinet.



\$77.50

Only \$15.50 Down—\$5.48 Monthly
Walnut Cabinet for above.....\$29.50
Front Panel Only.....\$10.00

New — RCA WIRE RECORDER

Complete Recorder—Reproducer, Portable, Efficient! Simple, anyone can operate. 1/2 hr. recording on one cartridge. Use and re-use some wire. Excellent reproduction. Complete, with tubes, mike, 7' cable & plug, Mike Stand, 3-1/2 hr. cartridges. 25 lbs.



\$139.50

Only \$27.90 Down—\$9.86 Monthly



T-17B HAND MIKE

BRAND NEW — Perfect Carbon Hand Mikes. Light wt., 200 ohms. Single button, press to talk switch. 5 ft. rubber cord, plug, dust cover. Terrific at..... **99c**



0-150 DC MICROAMMETER

Precision-made by leading mfrs. 2 1/2" Bakelite Case. All Brand New—Perfect DC meters. A Great Buy! No. S-437. Only **\$3.45**

HS-30 HEADPHONES

NEW Signal Corps Phones, 250 ohm Imped. with matching transformer to 8000 ohms. PL-540 Plug, 8' Cord. Soft rubber earplugs. Light, adj. headband. Amazing Bargain! **\$1.95**



Smashing Reductions! TRANSMITTING AND SPECIAL PURPOSE TUBES

Hams, Experimenters! Save NOW on these Great Surplus Tube Buys! All JAN Approved — All NEW and GUARANTEED. Many thousands in stock! Order NOW!

Hy69	\$1.65	809	1.50
Hy615	1.13	811	1.95
2AP1	2.25	813	6.75
2AP1A	5.25	814	4.50
2C26A	.75	826	1.50
2C40	2.63	832A/832	2.25
2C44	1.50	836	1.13
2K25/723A8	12.00	837	2.25
2X2/879	.90	838	3.75
3AP1	3.00	845W	3.75
3BP1	3.00	865	1.50
3C24/24G	1.20	872A/872	2.25
3CP1	6.00	874	1.95
3DP1	4.50	884	.75
3EP1	3.00	931A	1.88
3E29	3.00	954	.75
3FP7	3.00	955	.75
3GP1	3.75	956	.75
5AP1	4.50	957	.75
5BP1	3.75	958A	.75
5BP4	3.75	959	.75
5CP1	3.75	1616	3.00
5LP1	9.00	1619	.75
6AC7W	.68	1624	.90
6AK5	.90	1625	.53
9JP1	6.00	1626	.60
9GP7/9MP7	12.00	1629	.27
10y	.75	1851	.95
12DP7	6.00	2051	.53
75TL	2.25	7193	.45
OC3/UR105	.75	8005	3.15
OD3/VR150	.75	9001	1.05
304TL	3.75	9002	.90
316A	.75	9003	1.05
801A/801	1.13	9004	.90
807	.95	9006	.68

RIM DRIVE PHONO MOTOR

Price Slashed! Made by leading mfg. Sturdy, quiet motor. 9" Turntable. For 110 volt AC only. 78RPM. Complete with turntable. No. S-376. **\$2.49**



CRYSTAL PICKUP

Brand New, High Fidelity Crystal Pickup with tangent head. 7" mfg. center. Famous make. No. S-240. While they last! **\$1.88**

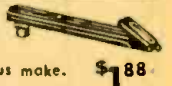

440 mmfd. Condenser

87 Plates, .070 Gap. Ceramic front and end. 2500 V. insul. Silver Contacts. 2 x 2 x 7". 1/4" shaft. **69c**



BUY OVER \$75 WORTH OF EQUIPMENT
Take ONE YEAR to PAY
20% Down—Pay Monthly

ORDER FROM
New York or Chicago
Shipments FOB N.Y. or Chicago
20% Deposit Required
with C.O.D. Orders
Send Full Amount of
Order—Save C.O.D. Chgs.
Prices Subj. to Change

NEW YORK
Offices & Warehouse
242 W. 55th St., N.Y. 19

NEWARK CHICAGO
ELECTRIC COMPANY, INC.
323 W. Madison St.
Chicago 6, Ill.

New York City Stores: 115-17 W. 45th St. & 212 Fulton St.

minals. For the preliminary loading adjustment, rotate the link coil for minimum coupling and tune the final amplifier for minimum plate current. Now, rotate the link coil to increase the coupling between the final tank circuit and the antenna; keep the final amplifier tuned for minimum plate current. Continue to load the amplifier by increasing the antenna coupling and returning the tank circuit for minimum plate current to the HK-54. With 2,000 volts on the plate of the HK-54, the amplifier may be loaded to an operating maximum of 130 milliamperes or an input of 260 watts. The r.f. power output under these conditions should be about 180 to 200 watts.

The transmitter is now tuned and

ready for operation on c.w. For AM phone operation, an audio-frequency modulator unit capable of supplying 75 to 100 watts output may be connected in series with the high-voltage plate lead from the HK-54, as shown in Fig. 1. A pair of 809's or TZ-40's make a good modulator for this transmitter.

The next installment of this article, to appear in an early issue, will describe adjustment of the transmitter's FM section.

Stewart-Warner plans to appoint an authorized Stewart-Warner television service station and each active television transmitting area in the United States. Service stations will be controlled by local proprietors but will be under supervision of the company's territorial distributor.

NEW LOW PRICES

SPEAKERS

5" P.M. Alnico 5 Magnet, \$115 each
6 for \$6.00

6" P.M. Alnico 5 Magnet, 169 each
6 for \$9.00

All other sizes in stock, at money-saving prices.

AUTO RADIO SUPPLIES

3 Section 66" Auto Aerial, Aluminum Cowl Type, ea. \$1.15
6 for \$6.00

OZ4 TUBES, each \$1.07
Minimum order, 6

SPARK Plug SUPPRESSORS. 11
See our Catalog for full line of auto aerials.

PHONO SUPPLIES

Crystal Pickup Arms..... 2.49
Webster No. 50 Changer... 21.17
Webster No. 56 Changer... 26.66
Webster No. 70 Changer... 43.20

Free \$2.50 permanent needle with each changer.

Volume Controls

1/2 MEG. volume control with switch and long shaft, ea. 59c
6 for \$3.25

15 ASSORTED VOLUME AND TONE CONTROLS (less switches) \$1.95

Money KITS Saving

Insulated Resistors, 1/2, 1 & 2 Watt..... \$1.95

20 Assorted Wire Wound resistors... 1.95

50 Popular Assorted Mica Condensers... 2.50

20 Assorted Tube Sockets... 1.00

20 Assorted Trimmers 1.00

I.F.'s 455 KC..... .45

WIRE

400 ft. (approx.) of wire in assorted colors and gauges, solid & stranded in 2 to 4 feet lengths, per pkg..... 99c

CONDENSERS Tubular Paper (600 V. Test)

Mfg.	Price Ea.	Per 100
.01	.08	\$ 6.50
.02	.08	6.50
.05	.10	8.00
.1	.12	9.00
.25	.17	13.50
.001	.08	6.50
.002	.08	6.50
.005	.08	6.50
.006	.08	6.50
.5	.26	22.50

"Illinois" Electrolytics

Mfd.	VDC	Price
10	25v	.30
100	25v	.48
12	50v	.34
16	150v	.36
20	150v	.38
24	150v	.38
30	150v	.40
50	150v	.48
8	450v	.38
10	450v	.42
16	450v	.54
20	450v	.60
40	450v	.80
100	15v	.45

"Illinois" Duals

16-16	150v	.50
20-20	150v	.52
30-30	150v	.60
40-20	150v	.60
50-30	150v	.68
8-8	450v	.68
10-10	450v	.74
20-20-20	150v	.84

10% discount on all electrolytics if purchased in lots of 10 or more. Mica Condensers, all sizes. 8c each.

TEST EQUIPMENT

Model 670 Superior VoltOhmmeter..... \$28.40
Model 905 McMurdo Silver "SPARX" Signal Tracer..... 39.90
Model 900 Vomax..... 59.85
Model 450 Superior Tube Tester..... 39.50
Minimum Order \$3.00—20% with Order.

TWO CONVENIENT PLACES FROM WHICH TO ORDER. PLEASE ADDRESS DEPT. CB

ELECTRONIC DISTRIBUTORS, INC., 620 W. Randolph St., Chicago 6, Ill.
ELECTRONIC PARTS CORP., 436 W. State St., Milwaukee 3, Wisc.

12lbs. SURPLUS ELEC-TRONIC PARTS \$2.00

A gold mine of parts for repairmen, amateurs, and experimenters... sockets, condensers, resistors, transformers, coils, hardware, wire, etc., etc. An outstanding bargain in usable parts! Send \$2.00 cash, check or M.O. today! (Pay small express charges on receipt.)

Balance C.O.D.—WRITE FOR CATALOG.

TWO CONVENIENT PLACES FROM WHICH TO ORDER. PLEASE ADDRESS DEPT. CB

TRANSATLANTIC NEWS

(Continued from page 38)

mined by Dr. Essen for their propagation through a vacuum, what is the probable error when a radar set, calibrated at 6.1 microseconds per 1,000 yards of range (remember that 1,000 yards of range = 2,000 yards of pulse travel), records a reading of 85,000 yards?

Situation in television

The single television station now operating serves an area around London containing 12,000,000 people. Regular service started in November, 1936, and has continued ever since, except for the war years. Considering that televisions could be bought before the war for as little as \$100 and that instruments giving an 8- by 6-inch image are now on sale at \$140, how many of them would you guess there are in use in an area containing between three and four million radios? The rather surprising answer is 11,500.

This lack of acceptance is puzzling for the quality of the images is good (frequencies up to 2.7 mc are radiated), the programs are quite attractive and many of the most important sporting and other outdoor events are broadcast. Nobody seems to know why television does not catch on.

My own view is that the man in the street regards it as being still rather in the experimental stages and has a feeling that a revolutionary invention may come along at any time to make present sets obsolete. He is likely to be right about the possibility of such an invention, but, even if it were made today, it would be some years before it could be brought into action here. I am told that there is much the same kind of sales resistance in America. Is it for similar reasons?

Things to come

Meantime I hear that research on 1000-line television is going ahead very well indeed. As you may know, we are going to develop a 1000-line high-definition television system side by side with the 405-line system. The results of all practical tests so far made confirm that, with horizontal polarization and a carrier frequency of the order of 100 megacycles, complete freedom from interference can be obtained. There are, though, some pretty thorny problems to be tackled on the purely vision side. Not the least of these is that of reducing the size of the spot on the screen of the cathode-ray tube to something much smaller than has hitherto been obtainable. For 1,000-line scanning you need a really minute spot—and one difficulty about focusing an electron beam sharply is that the individual electrons which compose it repel each other with enormous force. Quite remarkable results have been obtained with an entirely new method of focusing, about which I am not at liberty to say anything at the moment.

ELECTRICIANS! RADIOMEN!

Get this Valuable Book

FREE for Merely Examining Coyne's NEW Pay-Raising 3 VOLUME APPLIED PRACTICAL RADIO SET

Now—a sensational new practical set of radio books. Just off the press, gives you the "know how" on everything in Radio today! Basic principles to newest television and FM—how to construct, install, service, 800 illustrations, nearly 1,000 pages. Ideal for home training or field reference—backed by Coyne's 48 years of shop experience, to help you to biggest radio opportunities...

And here's our amazing offer: To prove the value of these great new books to you, Coyne will give you our new, practical "Business-Starting" book Free just for looking over the 3-volume set. Offer limited—act now! Just mail the coupon below. We'll send you the 3-volume APPLIED PRACTICAL RADIO set for 7 days' free examination and include our 250-page book, "Starting & Operating a Profitable Radio or Electrical Business". Look the set over for 7 days. If you like it, then pay its low cost on easy terms as shown in coupon below. If you don't want the set, just return it and owe NOTHING!

Either way, you keep the "Business-Starting" Book ABSOLUTELY FREE. SEND NO MONEY

Coupon below is just a request to see the new set and receive your free gift book. Mail coupon today.

Educational Book Publishing Division, Coyne Electrical & Radio School, Dept. C7-T1 500 South Paulina St., Chicago 12, Illinois

Send me your 3 volume set APPLIED PRACTICAL RADIO and my FREE gift "Business-Starting" book. I'll either return the set in 7 days and owe nothing, or send you \$3 within 7 days and \$3 a month until \$10.75 is paid. Or I'll pay \$9.75 cash. Whether or not I keep the 3 Volume Set, the Business-Starting Book is mine FREE as a gift.

NAME _____ AGE _____
ADDRESS _____
CITY _____ Zone _____ STATE _____

When working on polystyrene sockets and coil forms hours of grief can be saved by using the following method. Usually the heat of the soldering iron melts the material and loosens the pins, thus ruining the form or socket. By soaking an ordinary pipe cleaner in

RADIO SERVICE KITS

all NEW parts STANDARD BRANDS only we are DEPENDABLE

- #101—VOLUME CONTROLS—25 asstd carbon & ww; 5 ohms-2 megs..... \$4.95
 - #102—TUBE SOCKETS—10 asstd wafer moulded-ceramic-mica 4 to 8 prong..... 2.95
 - #103—MICA CONDENSERS—100 asstd.00001 to .01mfd/300-600 V..... 4.95
 - #104—CIRCUIT SELECTOR SWITCHES—25 asstd (2-24 positions)..... 6.25
 - #105—WIREWOUND RESISTORS—10 asstd fixed & adjustable; 5 to 100 watts..... 6.95
 - #106—"AC" SWITCHES—15 asstd Toggle-Rotary-Push-Micro-Thermo..... 4.45
 - #107—PRECISION RESISTORS—100 asstd carbon & ww; 6 ohm to 10.0 megs; 1/4 to 2% tol..... 14.95
 - #108—CARBON RESISTORS—100 asstd 1 ohm to 10.0 megs; 1 watt..... 2.50
 - #109—DUAL POTENTIOMETERS—10 asstd carbon & ww; 20 ohms to 2.0 megs..... 5.95
 - #110—POWER RHEOSTATS—10 asstd 10 ohms to 15,000 ohms; 25 watts..... 9.95
 - #111—ELECTROLYTIC CONDENSERS (in cans) 20 asstd; 4 mfd-2500 mfd/10-600 V..... 9.95
 - #112—BY-PASS CONDENSERS—60 asstd .0005 to .5 mfd/200 to 600 volts..... 2.95
 - #113—KNOBS—60 asstd Bar, Pointer, Instrument, Panel, etc..... 3.95
- ALSO: Westinghouse and GE METERS 0-1 ma DC; 3" square, 1000 ohms per volt
60" VOLT METER TEST LEADS (Mueller): Banana plugs & alligator (rubber covered) clips; red & black leads..... .95

EVERY RADIO "HANDYMAN" NEEDS THESE BASIC KITS! A KIT FOR EVERY PURPOSE!

25% deposit required on all orders. Add 25c for postage and handling

ALAMO RADIO SALES
Dept. R.C., 161 Washington St., NYC 6, N. Y.

water and wrapping it several times around the pin, a neat job can be done without damaging the material.

This stunt can also be used when soldering to crystal diodes, as they are easily damaged by heat.—Frank B. Lee, VE3AOZ.

QUICK FAULT FINDING

(Continued from page 29)

Upon inspecting the grid wire as it led from the bottom of the coil shield, it was noted that the wire insulation appeared cut. (This shield was not notched for the wire and was bolted tightly over the wire insulation.)

The meter was again connected as at the start of the tests and the r.f. probe again placed on the plate of the 6K7 tube.

This contact was held while a socket wrench was used to loosen the screws which held the coil shield against the grid wire. When the shield was slightly loose, a meter reading was obtained as shown—indicating the defect had been found and temporarily cleared—and that the signal was being amplified as this meter reading was higher than that obtained at the plate of the preceding tube as shown in Photo 2.

A closeup view of the pinched grid wire is shown in Photo 6.

Tape was applied and the coil shield was filed out at the point where the grid wire passed under it, the radio checked and found O.K.

EASY TRICKLE CHARGER

A small trickle charger can be constructed cheaply and easily by using an old power transformer and one or more low-voltage rectifier stacks. The transformer should have filament windings that can be connected in series to give between 17.5 and 18 volts. It is understood that the total current will be limited by the current-carrying capacity of the windings. If low-current rectifier stacks are used, it may be necessary to connect two or more of them in parallel to pass the full-load current.

A 1-megohm, 1-watt resistor is connected across each half of the high-voltage secondary to present a light load to prevent insulation breakdown caused by high-voltage surges.

When connecting a battery for charging, be sure to connect the positive terminal of the battery to the positive post on the charger. If you are not sure of the polarity of the charger, place two leads from the unit in a glass of salt water. Bubbles will rise from the negative pole when the current is turned on. A d.c. ammeter may be connected in the circuit in order to read the charging current.

WM. E. DANNEMAN,
Chicago, Ill.

ENGLISH RADIO POEM

The credit line for the above item, which appeared in our February issue, on page 84, was inadvertently omitted. This little piece, which begins "In the little town of Electron, away out beyond Anode Bend . . ." was reprinted from the magazine *Practical Wireless* (London).

RADIO-CRAFT wishes to express to our British sister periodical our regret for this unintentional omission.

RADIO'S GREATEST VALUES!

EDWARDS FM TUNER

CONNECTS TO ANY RADIO RECEIVER OR P. A. SYSTEM

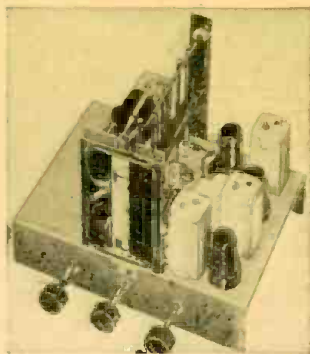

- 1—New Type Tuner (Three High Q Tuned Lines)
- 2—Full FM Band Coverage 87.5 to 109 Megacycles
- 3—Easily attached to existing radio receivers or Amplifier systems.
- 4—8 tubes
- 5—Latest type miniature tubes used for R F section for highest efficiency
- 6—All tuning lines and contacts silver plated
- 7—Permeability tuned ceramic IF and Discrimination for transformers
- 8—High Frequency Insulation used throughout
- 9—Tuning dial ratio 7½ to 1

- 10—Calibrated Dial (Full vision, easy to read slide rule dial)
- 11—Less than 10 Microvolts needed to produce complete limiting
- 12—AC operated 105-130 Volt —60 cycles. Self-contained power supply
- 13—3 controls
- 14—New F M (300 ohm twin lead cable) Antenna input

Net Weight: 10 lbs.

\$52.50
NET

GENUINE POCKET SIGNAL GENERATOR

MODEL 710 Pocket Generator can be conveniently slipped into one's pocket and taken out on the job for quickly locating and localizing faults—so you can give an immediate, accurate repair estimate right on the job. With the 710 you do a complete aligning job on a broadcast receiver—eliminating the necessity of bringing the receiver into the shop.

It comes in mighty handy as a spare signal generator and has many useful applications as a signal source for various operations.

Complete with tubes, shielded output cable, line cord and plug—ready to operate. Housed in attractive design metal case. Size 3 x 6 x 2½. Weight 2 lbs.

\$17.95
NET

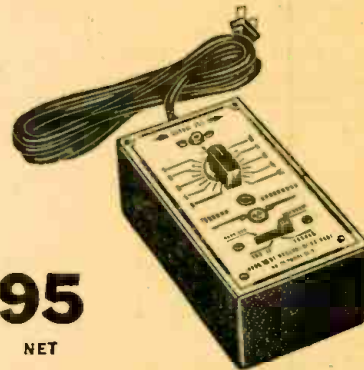

Three-way portable superhet kit, complete parts (excluding wire and solder) and cabinet of blue aeroplane cloth finish. Size 13 x 9½" x 7". Price \$13.75 not including tubes. 1 kit of tubes for above consisting of 1-1A7, 1-1H5, 1-3Q5, 1-117Z6, and 2-1N5's. Price \$3.75

SIX-TUBE 2-BAND SUPERHETERODYNE KIT

In a solid color wood cabinet (green, red), contains all parts (except wire and solder) to construct a high grade 2-band superheterodyne receiver covering regular broadcast and short wave bands. Tubes consisting of 2-6SK7, 1-6S07, 1-25Z6, and 25L6 included. Price \$16.45

FIVE-TUBE SUPERHETERODYNE KIT

Small bakelite cabinet, size 9" x 5" x 6", complete parts (except wire and solder) for the construction of a standard superheterodyne receiver using 50L6, 35Z5, 12SA7, 12SQ7, and 12SK7. All parts properly matched to chassis base. Price including tubes \$11.95

THREE-TUBE PHONO AMPLIFIER

Complete with tone and volume control. Price \$2.95

PHONO OSCILLATOR

Wireless phono oscillator transmits recordings for crystal pickup or voice from carbon mike to radio without wires. Price \$2.95

Write for our new catalogue showing new test equipment, tubes and a large variety of new replacement parts.

All prices are
F. O. B.
New York City

**RADIO DEALERS
SUPPLY CO.**

135 Liberty St., New York, N. Y.

WE SHIP
ANYWHERE
PROMPTLY

VERIFIED SPEAKERS

"They speak for themselves"

WRIGHT
Inc.

2234 University Avenue

St. Paul 4, Minnesota



NOW *Sound*
FOR YOUR SILENT PROJECTOR
Economically

\$5.95

Convert your 16mm silent projector to sound (regardless of make) with Apex sound head & radiolum adapter. Guaranteed excellent performance. Write today for free information.

APEX VIDEO • 12209 U Branford St. • Roscoe, Calif.

NEVER
BEFORE
IN PRINT

SEND 3¢ STAMP FOR POSTAGE

AMPLIFIER CORP. of AMERICA

398 Broadway,

New York 13, N. Y.

20 STEPS
TO PERFECT
AMPLIFICATION

32 - ELEMENT BEAMS

10-20 or 50 MC and up
72-ft. Dural Masts—One man raises.

Write for literature

U.H.F. RESONATOR CO.

GUION ROAD, RYE, N. Y.
Telephone Rye 2030



BARGAIN SPECIALS

The FINEST in HEADPHONES



Type P23. The Choice of the Air Corps headphones, highly sensitive, 8000 ohm impedance, bipolar magnets. Extremely comfortable sponge rubber ear cushions — stainless steel leather covered headband—concealed terminals—Six Foot Cord with PL55 plug. EVERY ONE BRAND NEW in Original Factory Cartons.

Stock No. 5A134 \$13.50. value. An Outstanding Buy, Only **\$2.95**



12 1/2 Ft. ANTENNA TELESCOPES DOWN to 1 Foot 4"

"Just It" for mobile equipment, portable receivers and transmitters. Ruggedly constructed—smooth telescopic action from 16 inches to 12 1/2 feet. Base is 7/8" in dia. with 3/4" threaded shank. By adding eyelets it makes an ideal compact fish pole. An Outstanding Value No. 38A39, Only **\$1.95**

ORDER NOW, from this ad Add Postage



BURSTEIN-APPLEBEE Company
1012-14 MCGEE STREET.
KANSAS CITY 6, MISSOURI

LEARN

ELECTRICITY OR RADIO

... in the
GREAT SHOPS OF COYNE
Train in a Few Short Weeks

Here at Coyne in a few short weeks you can train for your big opportunity in Electricity or Radio. You train on actual full-size Electrical or Radio equipment. 48 years training experience. For Veterans and non-veterans.

NOT A "HOME-STUDY" COURSE

All Coyne training is given here in our big Chicago shops. Not a Correspondence course. VETERANS! Coyne is authorized to train Veterans under the G.I. Bill. Coupon brings details.

FREE BOOK Two great opportunity fields —rush coupon for free illustrated book on whichever course you prefer—no obligation. Tells how Coyne helps you get better jobs.

Your Choice of 2 Great Fields

Send **FREE BOOK** and full details on course checked:
 ELECTRICITY RADIO

NAME.....
ADDRESS.....
CITY..... STATE.....

AUDIO OSCILLATOR WITH BAND SPREAD

(Continued from page 23)

value to a maximum of twice that value for each setting of the range switch when C1 and C2 are equal and constant.

Fig. 2 shows how R1 or R2 may be represented by a dual potentiometer, 2 fixed resistors, and a 2-pole, 3-position switch. Rx indicates the terminals of the variable tuning resistance. The fixed resistors have the same resistance as each section of the potentiometers and are connected in series with them to limit the minimum resistance in the circuit. On range A, the variable and fixed resistors are in series to establish a maximum value for R1 or R2. At B, one potentiometer and its resistor are used. In this case, Rx is reduced to one-half its original value. For range C, the elements are in parallel resulting in a variable one-quarter of its value on range A. Fig. 2 is duplicated for R1 and R2, and C1 is equal to C2, the oscillator tunes as follows: With the range switch at A, the variable resistance will vary from a maximum of Rx to Rx/2 as the frequency varies from F to 2F. At B, the range is from Rx/2 to Rx/4, and the frequency range is 2F to 4F. The frequency varies from 4F to 8F as the resistance varies from Rx/4 to Rx/8

on range C. With only 3 positions, we have a tuning range 8 times the base frequency. If we couple the 2 dual potentiometers to a common shaft with a calibrated dial, we have a system of multiplying the base frequencies F, 2F, and 4F by a factor of 2 for one set of values for C1 and C2.

This scheme has advantages for the constructor. If the tuning, coupling, and feedback condensers meet specifications previously discussed, it can be assumed safely that the tuning will follow the calculated frequency and the dial calibration will be a true representation of $F = 1/R$. The dial can be predesigned and does not have to be arrived at by calibration.

The dial becomes a constantly variable multiplier capable of doubling the base frequency selected by the range switch.

Increasing the range

By selecting a 6-circuit, 12-point switch (Fig. 3), 3 additional values of C1 and C2 can be switched into the circuit to give a frequency range 2,048 times the base frequency. The tuning network is connected to the amplifier at points X and Y on Fig. 2. With the

(Continued on page 84)

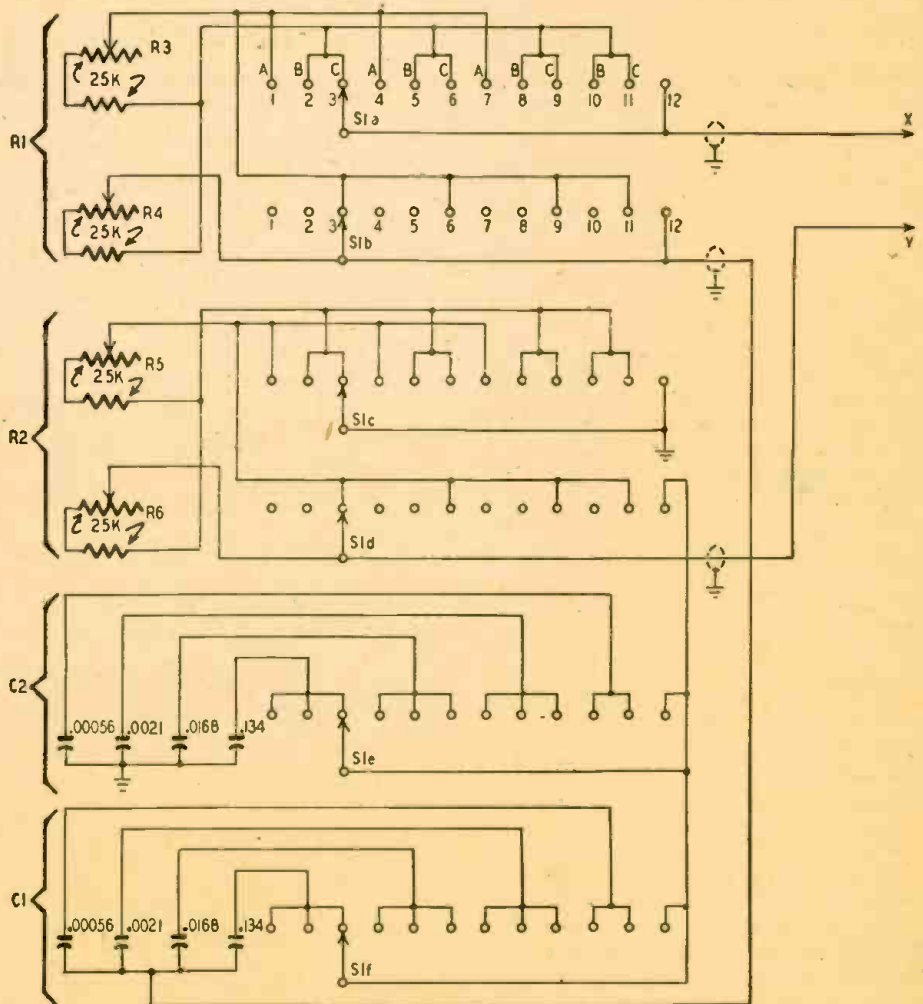

S1a, S1b, S1c, S1d, S1e, S1f - 6 CIRCUIT, 12 POSITION SHORTING TYPE SWITCH.
R3 R4 R5 R6 - 25K POTS GANGED.

Fig. 3—The system of switching resistors and condensers which gives 11 useful ranges.

"TAB"

• NEW GUARANTEED

That's A Buy

ELECTRONIC PARTS •



PRECISION RESISTORS
SHALLCROSS MEPCO,
INST. RES. CO. OHMITE,
WE, and others for ME-
TERS, BRIDGES, AMPS
& LAB EQUIP.

ACCURACIES • 1/2% • 5% • 10% (REST 1%)

1	2	3	4	5
20	25	50	75	80
100	101	150	300	350
400	500	1250	1500	2000
2142*	4000	4300	4900	5000
7950*	8000	9710	10000	12000
15000*	17000	20000*	30000*	50000
80000	85000	90000	147000	168750

Above sizes asstdTEN for \$2.50
 2000* 5000* 10000* 13000* 14000*
 15000 20000 20100 22000 25000
 Above sizes asstd39c ea.TEN for \$3.00
 33000 40200 50000 80000 95000
 Above sizes asstd60c @TEN for \$5.00
 ONE Megohm WW1% accy
 each 90c@THREE for \$2.00
 2meg. 4.5meg. 5meg. 10 meg.SIX for \$3.00
 WRITE FOR OTHER SIZES FROM STOCK

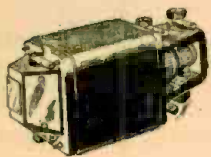

DYNAMOTOR NEW TAB
TESTED GTD 6V Inpt/3
Amp. output 240V/100ma
or 125ma Inpt duty. HI-
EFF P'MAGNET ALNICO
12/24V Inpt. Rated 500V
/50ma at 12 or 24V Inpt
\$3.49

Dynamotor 12 or 24V
Inpt. 275V/110 ma &
12V/3A**\$1.95**

Guaranteed used S.C. & NAVY EQUIP CRYSTAL
CALIB SIG GENERATOR 8-15mcs & 45 to 77mcs;
2nd, 3rd & 4th Harmonics usable coverage to 230
mcs. Consists of 6J5Xtal osc. 9006 DET. 2/63J7
AMP. 9002 Two range osc. 5Y3G FW RECT.
Attnr 10000microvolts, 115V/60cy op. RUGGED
DSGN. SPECIAL**\$45.00**

BC 342 RCVR 1.5 to 18mcs. 115V/60c\$34.95
 VACUUM CONDENSER 50MMF/20000V. 6.95

ANTENNA PARABOLIC RADAR ASSEMBLY \$16.95
 2 1/2" Dia Drive & Selsyn motor CO-AX
 DYNAMOTOR 28v Inpt/250v/60 ma out. \$1.29
 DYN 28vIn/300v/240ma/150v/10ma 3.48
 GYRO SERVO BENDIX 12800-TB Complete 9.95
RAYTHEON VOLTAGE REGULATOR 49.95
 198to242V In. OUTPUT VOLTS 220V/
 500WATTS/50-60cy 1/2 of 1% Reg.
 VAC CONDERS 50MMF/7500V 2.95
 100MMF/7500V 4.95

RAYTHEON VOLTAGE REGULATOR
CASED NEW S.C. TROPICALIZED
 Adj. Voltage Inpt 95-130V/60cy, output 115V .58AMPS.
ONE HALF 1% REGULATION. WT 20lbs 6 1/2 H8 1/4
 L 5" W OVER-
 LOAD PRO-
 TECTED
 RUGGED
 DSGN.



"TAB" SPECIAL **\$10.95**

WRITE FOR NEW CATALOG
 \$2 Min. order FOB N.Y.C. Add Postage all orders
 and 25% deposit. Worth 2-7230. Send for catalog
 300. Specialists in International Export, School, Col-
 lege & Industrial trade. Money Back Guarantee.



COLLINS ART/13 SPEECH AMPLIFIER COMPLETE
 INPT DYNAMIC OR CARBON MICROPHONE OR LINE
 INPT: Outpt PP class "B" GRIDS. Noise level down
 -55DB. INCLUDES INPT TRANSF. 1st AUDIO to
 PPGrids Modulator Tubes. 6V6 Sidetone adj audio osc
 Amp & Hphone monitoring jack. WT 5 LBS DIM
 7 1/2 L. 3 1/2 W. 5" H. Minus tubes & pwr supply.

"TAB" SPECIAL **\$4.95**
 WITH Two 6V6 & 6SJ7 **\$7.49**

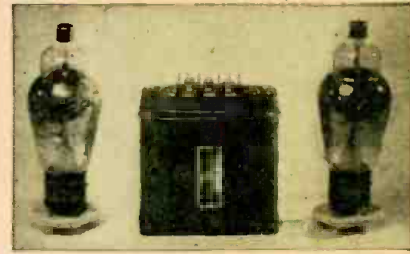

CONSISTS OF TWO JAN NEW 866A TUBES.
 TRANSFORMER GARDNER ELEC CASED 2.5V
 10 AMP. 115V/60cyInpt. H.V. Insld 9000V wkg
 similar to illustrated unit: "TAB" Tested 16000
 VAC Test; Same mig as KENYON T389—SOCKETS
 CERAMIC JOHNSON 224.
SPECIAL \$5.95

"TAB" • Dept. 8RC, Six Church Street. New York 6, N. Y., U.S.A. • "TAB"
 THAT'S A BUY • CORNER CHURCH & LIBERTY STS., ROOM 200 • THAT'S A BUY

Airborne Metal Seeker

THE "doodlebug," an airborne magnetometer originally devised to locate submarines under water where radar cannot penetrate, is a true magnetic metal locator. The existence of the "doodlebug" was announced in the August, 1946 issue of RADIO-CRAFT, but a description of its workings is given for the first time in the *Bell Laboratories Record* for March, 1947, by W. J. Shackleton.

Reduced to its essentials, the magnetometer system employs a small strip of magnetic material of high permeability, magnetized to well beyond its saturation point by an a.c. winding. With no external field present, or with the magnetometer perpendicular to any existing field, the magnetization in the core changes from saturation in one direction to saturation in the other with the frequency of the exciting current, and the voltages developed across the coil may be analyzed into a series of odd harmonics of the exciting frequency. In the presence of an external magnetic field, however, the alternating magnetization in the core is biased in one direction or the other. As a result, the voltage across the coil contains even as well as odd harmonics, and the magnitude of the even harmonics is proportional to the strength of the external field. If such a magnetometer, held in

fixed orientation, is carried through a region where the external field changes, as in the vicinity of a submarine or other mass of magnetic substance, the change in the even harmonics can be

detected and observed as a signal on a suitable indicator. A change in the field of the order of 1/20,000 part of the earth's field can be recognized in the
 (Continued on page 81)

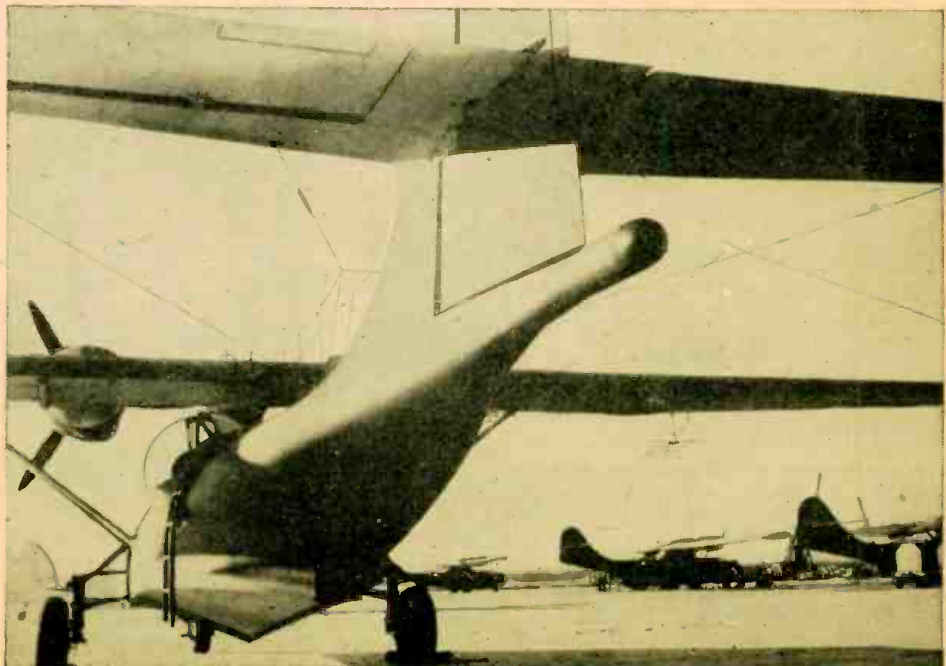

The "doodlebug" is carried in the rounded cylindrical projection at the tail of the plane.

B19 SET OWNERS

**AUTHENTIC REPLACEMENT PARTS
And SERVICE DATA FOR MARK
II And III NOW AVAILABLE!**

B19 TRANSMITTING and RECEIVING SETS, complete with SPARE PARTS—write for prices.
Dynamic Microphone and Headset, moving coil type \$2.50
Cord 16' 5 wire, with plugs to fit above item .50
Telegraph Key S.C.J.-37 with cord and PL-55 plug .39
Buzzer—High frequency, adjustable, operates 6-24 volts .59
B19 Remote Control Kit with 3 control boxes, 5 cables 3.00

TUBES EF50—HYE1148—907 Each \$1.00
6K7G, 6V6G, 6HG Each .75
ORIGINAL CARTONS 6B8G, 6K8G Each .90
B19 2 Complete Sets Brushes and 6 fuses, Power Supply No. 1 or 3, 6 pilot lights \$1.00
0-500 Microammeter 0-600 x 0-15 DC Scale with Multipliers 2.50
Hardware Kit: Over 1200 pcs. asst. & packed separate. About 2 lbs. net .65

CAPACITORS ELECTROLYTIC TUBULAR
50 Volt, 12 Mfd. 4 for \$1.00
450 Volt, 32 Mfd. or 2 Mfd. 4 for 1.00
PAPER-TUBULAR: 1 Mfd. 1500 volt. \$.24 each
1.025 Mfd. 500 volt—6 for \$.79

MICA CAPACITORS
.01 .003 .006 .0003 .0007—1000 volt 6 for \$1.00
.001 .004 .0001 .0004 .00003—500 volt 10 for \$1.00
.002 .005 .0002 .0005 .00007—300 volt 3 for \$.25

VARIABLE AIR CAPACITORS Each Sec. \$1.50
P.A. Single 12.3mmf to 562.8mmf. Vernier dial .65
6.5mmf to 140mmf. 19 stator, 18 rotor, plates, screw driver adjusting .29
Trimmers Ceramic 4 to 30 or 7 to 45mmf. 2 for .25
Padders Ceramic Comp. 20mmf or 50 mmf. 2 for .25

RESISTORS 300 Asst. 1/4, 1/2, 1 and 2 watt Carbon and wire wound .55.25
All values as used in a maintenance kit.
I.F. Transformers: 465KC Iron core tuning 1st, 2nd, or 3rd 3 for \$1.75
Potentiometers—1 Meg. 100,000, 20,000 6 ohms. Assortment \$.50

Dual Control Box w/3 band sw. 3 bar knobs, 3 plugs, redlight and holder \$.39
Phone Plug PL-55 and Phone Jack Both \$.25
CORD—5 1/2' W/PL-55 Phone Plug and JK26 Jack, rubber covered, 2 conductor. Jack takes PL-54 Plug 3 for \$1.00
CORD—7 1/2' W/PL-68 Mic. Plug, DPST Palm switch and JK48, rubber covered, 3 conductor, used with LIP or Throat Mic 3 for \$1.00

WE CAN FURNISH ANY ITEM FOR B19 SETS
25% Deposit on C.O.D. Orders. Shipped F.O.B. Lima, O.
Minimum Order \$2.00 P. O. Box 442

FAIR RADIO SALES
223 S. MAIN ST. • LIMA, OHIO

LEARN EITHER ELECTRICITY OR RADIO

In a Few Weeks...in the
GREAT SHOPS OF COYNE
Not a "Home-Study" Course

You'll learn fast at COYNE, using actual full-size equipment. Real shop work plus necessary theory. 48 years' success. 2 great Opportunity fields—push coupon for FREE BOOK on course you prefer. For Veterans and non-veterans.

ELECTRICITY RADIO

Includes Motors, Armature Winding, Industrial and House Wiring, Power Plant Work, Maintenance, both AC or DC. Also new field of Industrial Electronics. Learn to build, shoot trouble on Radios, Public Address Systems, Sound Pictures, FM, Television. Training in Electric Refrigeration included. Send coupon.

FREE BOOK Get big, illustrated book on either course—no obligation. Tells how Coyne helps you.

B. W. COOKE, Dir.,
COYNE ELECTRICAL SCHOOL, Dept. C7-78H
500 S. Paulina St., Chicago 12, Ill.

Send FREE BOOK and full details on course checked:
 ELECTRICITY RADIO

NAME.....
ADDRESS.....
CITY..... STATE.....

SET AND SERVICE REVIEW

(Continued from page 25)

ceiver is the *Emor One-World* radio, an all-wave, 5-tube superheterodyne built in the form of a globe. The set is tuned by revolving the globe, and stations are indicated on translucent rectangles which are lighted as the station is tuned in. The volume control and wave-change switch are fitted as sleeves over the tubular stand, "eliminating unsightly knobs or dials" according to the manufacturer. The set was originally a British model, and only recently has been produced in the United States.



Emerson radio with speaker and hearing aid operating simultaneously.

A TUNABLE AERIAL

THE problem of television "ghosts" and those created by wider tuning bands in the television and FM spectra is at least partially solved by a new antenna, which can be rotated for best reception from any given direction, and can be lengthened or shortened to accommodate higher or lower frequencies.

Developed by Farnsworth, the antenna is in appearance a dipole with a large central head which mounts on the mast. Within this head are two motors, one for orientation and one for tuning. Four push buttons on a control board allow the operator of the television or radio set to rotate the antenna clockwise or counterclockwise through 180 degrees and to increase or decrease the resonance frequency.

strength of direct signals in comparison to those from strong reflected waves which create delayed images (referred to as "ghosts") on the television screen.

The de luxe Farnsworth antenna installation has a three-section arm extension with a frequency range of 2 1/2 to 1, from 46 1/2 megacycles to 117 megacycles. It has three sections of telescopic tubes which form the extensible members of the tunable dipole. The length of each half of the dipole is controllable from 26 to 66 inches as measured from the midpoint.

A smaller antenna having two sections of telescoping tubes, with a frequency range of 1.8 to 1, from 46 1/2 megacycles at the bottom end, when extended, to 85 megacycles at the top end

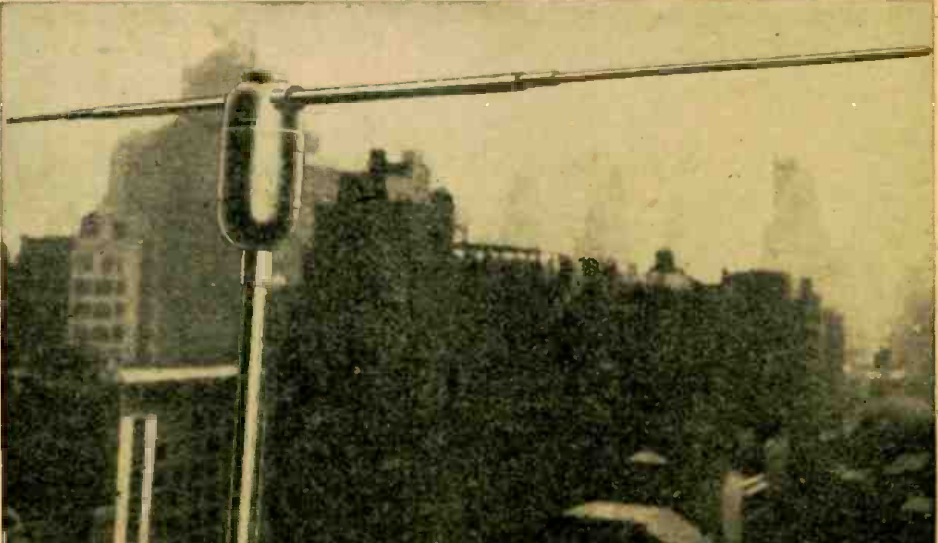

The de luxe antenna in position. The rotation and extension motor is in the center casing. An antenna of this type would be a highly useful tool for the television installation man.

Orientation, which is the main feature of this antenna, decreases shadows to a minimum by aligning the receiving antenna as nearly as possible with the transmitting antenna, increasing

when retracted, is also being field-tested and made ready for production. The length of this antenna is 36 inches when closed and 66 inches when open, measured on either side from center.

Do you need METERS

We carry a complete line of surplus new meters suitable for every requirement, such as portable, panel, switchboard, recording instruments, laboratory standards, etc.

**VOLTMETERS
AMMETERS
MICROAMMETERS
FREQUENCY METERS
MULTIMETERS**

**MILLIAMMETERS
DECIBEL METERS
HOUR METERS
POWER LEVEL
AND OTHERS**

Over 50,000 meters in stock

We also stock various surplus components, tubes, parts, and accessories and can supply large quantities for manufacturers, exporters, etc.

Send for free Circular
MARITIME SWITCHBOARD

336A Canal Street New York 13, N. Y.
Worth 4-8217

EASY TO LEARN CODE

It is easy to learn or increase speed with an Instructograph Code Teacher. Affords the quickest and most practical method yet developed. For beginners or advanced students. Available tapes from beginner's alphabet to typical messages on all subjects. Speed range 5 to 40 WPM. Always ready—no QRM.

ENDORSED BY THOUSANDS!

The Instructograph Code Teacher literally takes the place of an operator-instructor and enables anyone to learn and master code without further assistance. Thousands of successful operators have "acquired the code" with the Instructograph System. Write today for convenient rental and purchase plans.



INSTRUCTOGRAPH COMPANY

4701 Sheridan Rd., Dept. RC, Chicago 40, Ill.

BE YOUR OWN BOSS!

MAKE MORE MONEY

25¢

40,000 WORDS IN TEXT

NO ADS ALL "MEAT!"

Money Back Guarantee

NATIONAL PLANS COMPANY

Box 26RA, Ansonia Station New York 23, N. Y.

In "CASH IN" you now get THE real money-makers — dozens of profitable tested mail order plans, confidential business secrets, dozens of practical tested formulas, successful test and schemes — actual experiences of men who have started on a shoe-string—with less than \$10 capital. 25¢ a copy postpaid. Send U. S. stamps, money order, or coin.

Get Started in Radio

10 "HOW-TO-DO-IT" BOOKS

Get a solid foundation in radio by means of these 10c timely text books. Each clearly written, profusely illustrated, contains over 15,000 words. You'll be amazed at the wealth of information packed into these handy books. Excellent for reference—ideal for technical library. Your money back if not satisfied.

5 BOOKS for 50c
10 BOOKS for \$1.00

Sent to You Postpaid

1.—How To Make Four Doerle Short Wave Sets
2.—How To Make The Most Popular All-Wave 1 and 2 Tube Receivers
3.—Alternating Current for Beginners
4.—All About Aerials
5.—Beginners' Radio Diagrams
6.—How To Have Fun With Radio
7.—How To Read Radio Diagrams
8.—Radio for Beginners
9.—Simple Electrical Experiments
10.—Television

Remit by check or money order—register letter if you send cash or stamps.

RADIO PUBLICATIONS

25A West B'way, New York (7)

Wider spacing of FM channels, rather than better receivers, is advocated by many as an immediate practical solution of the FM interference problem.

HAM ANTENNA TOWER
(Continued from page 22)

beam with a power gain of 10. Note that this is actual gain and means that, using 100 watts and pointing the beam on Boston, for example, the same signal is produced in Boston as is obtained by using 1,000 watts and a folded dipole. From this tower last summer the first three stations worked on 6 meters in the first

On the next corner is the 32-element, 425-mc beam. This has been shown to over a dozen amateur radio clubs from Boston to Washington in lecture demonstrations on the absence of ground effects in high-gain beams. It has a gain of 64 over a half-wave folded dipole. Using this type of antenna, portable in

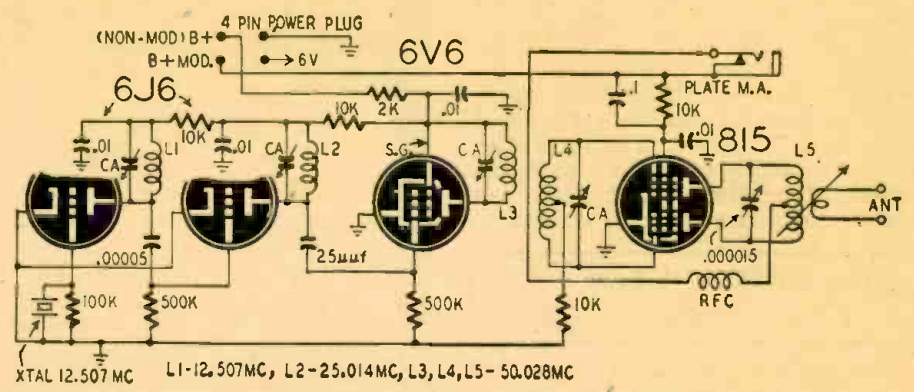

Last year's transmitter. Ca, 7-plate, screwdriver-adjusted air trimmers; L1, 28 turns, 3/4 in. O.D.; L2, 24 turns, 1/2 in. O.D.; L3, L4, 7 turns, 7/8 in. O.D.; L5, 7 turns, 1/4 in. O.D.

one-half-hour of operation were Bridgeport, Hartford, and Boston. This was done with an 815 final, powered only by a storage battery and generator to about 30 watts. We expect plenty of QRM-free contacts on the 6-meter band this summer.

a car on a distant mountain, with a 54-foot Dural mast in sections, reliable QRM-free communication well over 100 miles is expected this summer. Wednesday evening 8 pm will be the time for 425-mc work on the tower, and schedules will also be looked for from possible points of 2-way contact in New York, New Jersey, and Connecticut.

On the second corner is a 32-element, 2-meter beam. This is our pride and joy! It lights a flashlight bulb on a dipole 155 feet away from an 815 on 144 mc! The power gain, carefully measured by the distance method (which does not require the calibration of anything) using equal field strength at varying dis-

On the fourth and last corner is installed a 30-inch aluminum parabola (true paraboloid of revolution, or "dish"). This had not had its dipole and first reflector installed at the time the picture was taken. A good lighthouse

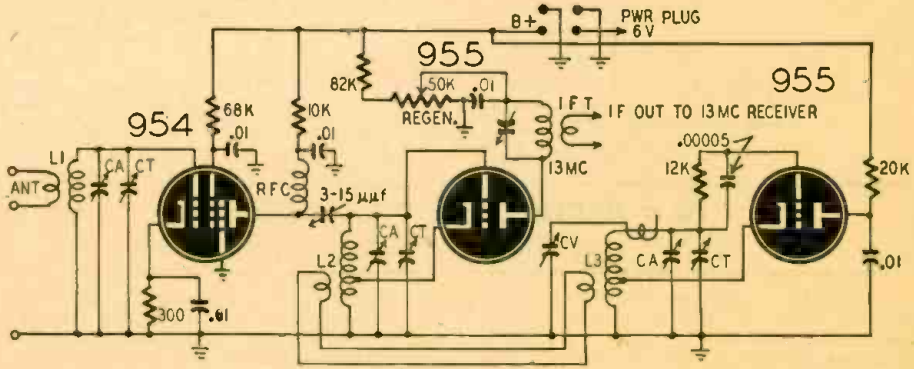

The converter L1, L2, L3 to suit band wanted. CA, air trimmer; CT, CV, 3-plate tuning cans.

tances, is 91. This again is actual, but more of that after this summer's trials. The front-to-back ratio in distance is 106 to 2, giving the same signal 106 miles ahead as 2 miles behind the antenna. This is a power ratio of approximately 2,609 front to back. This gain and discrimination is of course used on the receiver also. The cone of radiation is about 24 degrees total angle from the no-signal point on one side, through the maximum, and over to the no-signal point on the other side. It is about the same also for top to bottom, or vertical, angle.

tube co-ax oscillator is ready, putting out about 1 watt on 1,100 to 1,300, calibrated; but it is problematical whether time available will permit operation on the 1,250-mc band this summer. However, a little later in the fall (given about 2 weeks' notice) schedules could be tried with Manhattan, Long Island, or New Jersey. Don't forget that we can see halfway to the RCA building from the tower.

All of the beams are mounted on Dural rotating masts, are rotated by hand, and can be moved up or down 10 feet or more in Dural tubes clamped to

NUMBERS 4 and 5 OF THE WALSCO Hit Parade

THE SENSATIONAL, NEW, SCIENTIFIC

WALSCO STANDARD TEST RECORD

FOR IMMEDIATE... ACCURATE... AUDIBLE ADJUSTMENT OF RECORD CHANGERS AND COIN OPERATED PHONOGRAPHS... SOLVES THE PROBLEM OF ADJUSTING PICKUP AND TRIPPING MECHANISM THROUGH

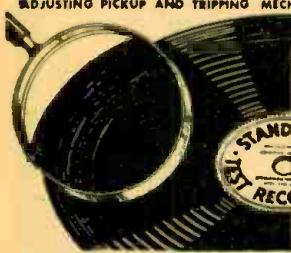

- Three Tone lead-in grooves permits immediate adjustment to proper set down position of the pick-up through audible means.
- Made to RMA and NAB standards.
- Record plays in less than 40 seconds.
- Audio tone at end of record indicates proper adjustment of tripping action.

The WALSCO Standard Test Record saves time and increases efficiency in the adjustment of record changers and coin operated phonographs. Write for full information.

WALSCO UNIBELT THE UNIVERSAL DIAL DRIVE BELT CAN BE CUT TO FIT ANY DIAL DRIVE Will not Slip or Stretch

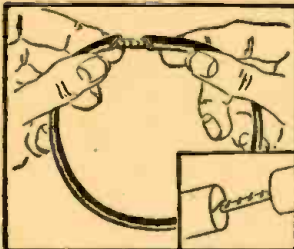

"UNIBELT" comes in 5-foot length spools and can be installed without taking dial mechanism apart. A real time and money saver. Eliminates the need for stocking numerous sizes of belts.

Free sample and literature. Write to Dept. 8B

WALSCO products

Help The Radio Man

WALTER L. SCHOTT CO. BEVERLY HILLS CALIF. CHICAGO 5, ILL.

MINIATURE TEST OSCILLATOR

Pocket size 1 1/4" round, 5" long. Very convenient for servicing and aligning RF and Audio circuits. Supplies 60 cycle modulated RF: 100 KC to 5 MC gives continuous coverage for 1 1/2 Broadcast and one Short Wave band on harmonics. Uses 6BA6 tube electron coupled for stability. 115 V. AC operated. \$7.85 Postpaid or send \$1.00 and pay \$6.95 C.O.D. You must be satisfied or money cheerfully refunded.

DeBaugh Company, Dept. RC-2
400 Allegheny Avenue, Towson 4, Maryland

SURPLUS SPECIALS

10" Television Kits R.C.A. Sweeps.....	\$100.00
with tubes 10" R.C.A.	150.00
G.E. 28 MFD OIL 440 V.A.C.	1.75
G.E. 1.1 MFD 7000 V.C.C.	1.00
Power Transformers TR10-32 6.3V. 5V. 370V. TR1042. 3400V	1.50

TIRET ELECTRIC CO., INC.

6303 BROADWAY WOODSIDE, N. Y.

TECHNOTES

... SPEAKER CONE REPAIRS

Very often when a damaged speaker cone is being repaired the edges of the break just come together and cannot be joined securely with cement. Coat the edges of the break with cement and cover with a single ply of facial tissue. Apply a thin coat of cement over the tissue. The tissue is thin and absorbent and will retain the cement without adding to the thickness of the cone.

ROBERT D. CARLEN,
Brooklyn, N. Y.

... PHILCO 46-1201

This model will experience complete loss of reception for other than local stations. The trouble is in the second i.f. transformer, which during manufacture was accidentally dipped in wax having a too low melting point. The heat from the rectifier and output tubes may cause the transformer to detune after a few hours usage. This i.f. transformer should be replaced. The new series of i.f.'s that have been corrected may be identified by a blue dot.

JOHN B. MIELUS,
Lancaster, Penna.

(We have been informed by the Philco Service Department that the replacement for the second i.f. transformer in this model, No. 32-4005, is furnished in a kit known as AD-1024. This replacement transformer is available with complete installation instructions.—Editor)

... DIAL CABLES

The customary method of obtaining slow-motion tuning on variable condensers is to wrap several turns of dial cable around a 1/4-inch tuning shaft and pass it over a large drum on the condenser shaft. This method is not always satisfactory because the cable creeps and jams as the shaft is turned.

Try forcing a small rubber grommet on the tuning shaft so that it will fit tightly, and pass the dial cable through its slot. This will prevent the cable from slipping or weaving along the shaft and will prevent chafing and wear at this point.

J. F. JOHNSON,
Berkeley, Calif.

... ZENITH 55319

After these sets have been in use for some time, the push buttons will not bring in stations at full volume even after they have been carefully adjusted to the frequencies of the stations. This is because the wiping contacts on the push-button assembly have lost their tension. Cleaning and bending the contacts will improve the tuning.

JOHN FINDERLE,
Modesto, Calif.

NOW YOU TOO CAN BUILD 15 RADIOS

COMPLETE KIT \$14.75



ABSOLUTELY NO KNOWLEDGE OF RADIO NECESSARY

You Need No Additional Parts

The PROGRESSIVE RADIO KIT is THE ONLY COMPLETE KIT. Contains Everything you Need: Instruction Book, Metal Chassis, Tubes, Condensers, Resistors and all Radio Parts.

The 36-Page Book written by Expert Radio Instructors teaches you to build radios in a Professional Manner. You will learn to wire and solder like an expert. You start with a 1-tube receiver. Before you are done with this kit, you will have built 11 Receivers, 1 Public Address System and 3 Transmitters.

PLUS membership in Progressive Radio Club. Entitles you to free expert advice and consultation service with licensed radio technicians. Complete Kit shipped C.O.D. plus postage, or send check or money order for \$14.75, and we will pay postage. Or write for further information.

PROGRESSIVE ELECTRONICS CO.,

DEPT. RC-4, 22 HAVEMEYER STREET

BROOKLYN 11, N. Y.

PROGRESSIVE ELECTRONICS CO., Dept. RC-4
22 Havemeyer St., Brooklyn 11, N. Y.

Check or money order inclosed. Postage Prepaid C.O.D. I will pay postage. Please send me further information.

NAME

ADDRESS

CITY ZONE STATE

SPECIAL OFFER!

Electrical and
Radio Tester
with each
PROGRESSIVE
RADIO KIT

BUILD YOUR OWN FAST FREEZER

It's easy to build this household appliance and profitable to use. Save up to 75%. Operates on 110 or 32 volts. Plans show 5 sizes and are easy to follow. ENJOY MAKING ONE OF these freezers from new or used parts. No expert knowledge needed. Mail \$1.00 bill or check for complete plans and catalog. LE JAY MFG. CO., 456 LeJay Bldg., Minneapolis 5, Minn.



BC-221 AS SIG GENERATOR

The Signal Corps SCR-211 or BC-221 frequency meters may be used as accurate signal generators. It is not necessary to apply any type of modulation to the signal. To use, connect the output of the meter to the input of the receiver. Put an a.c. voltmeter across the diode load of the receiver and align for maximum deflection.

These meters can be used also as frequency deviation meters by connecting the vertical amplifier of a scope across the headphones and applying a 60-cycle sweep to the horizontal amplifier. The deviation can be determined by observing the resulting Lissajous patterns.

FELIX LAMB,
Fayetteville, Ark.

(Loading the oscillator of the BC-221 will cause considerable frequency shift and it is advised that the signal for the receiver be picked up by one or two turns of insulated wire wrapped around the antenna post of the meter and connected to the receiver before calibration. This should provide sufficient coupling without loading. Some models of this frequency meter are available with 400-cycle modulation built in.—Editor)

PHILCO 40-140

When intermittent reception is the complaint, check the coupling condenser between the plate of the 7C6 and the grid of the 7B5. This can be done by moving it gently in both directions. If the set cuts out as the condenser is moved, replace it with a 0.004- μ f, 600-volt unit. If tests eliminate the condenser, replacing the volume control may help. This trouble is caused by the carbon element of the control becoming glazed, and in the more severe cases acquiring dead spots.

JOHN W. FINDARLE,
Modesto, Calif.

OSCILLATIONS

When servicing sets which develop parasitic oscillations, it pays to check the receiver circuit with the original diagram. Often an inexperienced serviceman will change the circuit and route leads in places where parasitics may develop. Often the trouble will not develop until the set has warmed up. This is especially true when some of the tubes have been replaced. Asking the customer if the set has been serviced recently will often provide a clue to the source of the trouble.

JOHN W. FINDARLE
Modesto, Calif.

See CANNON-BALL HEARING AID for Radio Reception

Easily attached to any Radio for private reception with or without loud speaker. Write

C. F. CANNON COMPANY
SPRINGWATER, N. Y.

Headset Headquarters

F. M. KIT (88 to 108 mc.)

Consists of Set of Matched Coils, Variable Condenser, Schematic and Instructions to Build a Tuner.	\$4.95
ELECTRIC PHONO MOTOR, complete with Turntable	\$2.95
CRYSTAL PICK-UP ARM	1.75
CRYSTAL CARTRIDGE	1.25
LOOP ANTENNA, assorted sizes, oval shape	.39
RESISTANCE CORDS, 160 to 290 ohms	.49
OSCILLATOR COIL, 456KC	.19
I.F. COIL, 456KC	.59
SELENIUM RECTIFIER, 150 MA	.95
BROOKS INVERTER, 50 Watts-110 V (also available in 220V)	8.95
VOLUME CONTROLS, any size with switches	.39
VOLUME CONTROLS, any size less switches	.19
ELECTROLYTIC, P-B, 20/20-150V	.26
ELECTROLYTIC, C-D, 40/40/20-150V-25V	.44
1000 ASSORTED CONDENSERS, .002 to .1	39.50
1000 ASSORTED RESISTORS, 1/2 Watt	15.00
BROOKS RADIO DISTRIBUTING CORP.	
80 Vesey Street	Dept. A.
	New York (7), N. Y.

MONEY TALKS!

DOUGLAS OFFERS

The Lowest of Low Prices on the Map!

METERS AT SPECIAL PRICES	Alliance Phono Motor and Astatic Pickup Kit, Special \$4.95
Marion 3" 0-1 ma, 0-100 ma, 0-200 ua, 0-500 ua. Your special price \$3.75	SPECIAL
Marion 2" 0-2 ma, 0-5 ma, 0-500 ua. Your special price \$2.85	Federal Selenium Rectifier, 100 ma, 92c ea. A.C., D.C. Choke, 4.5 henries, 50 ma, 200 ohms, Special 74c
DOUGLAS Decibel Recording Meter, for magnetic or crystal recording. Your special price \$4.98	CHASSIS AND CABINETS
TELEVISION PARTS, all guaranteed	5x0 1/2 x 1 1/2 20 gauge steel black finish. Special 53c
CHASSIS	Amplifier Chassis 5 1/2 x 10 1/4 x 9 with top. Special \$2.06
17x13x3 Cadmium Plated, all sockets, trans, pot, holes punched. Special \$5.80	Metal Cabinet 10x8x10. Special \$2.40
TRANSFORMERS	New Pencil Soldering Iron with interchangeable tips. Your special price \$1.20 with 1 tip
High Voltage Type T-8 2200 volt 2 ma. Separate 2.5 volt 2 amp, winding. Special \$7.95	MidKet I.F. coils, iron core tuning. Special 77c ea.
Low Voltage Type T-9 385-0-385, 200 ma. Separate 5 volt 3 amp, Separate 0.3 volt 5 amp, Separate 8.3 volt 5 amp. Special \$8.50 ea.	AMPLIFIER KIT, A.C., D.C., 3 watt output, complete with tubes, parts, chassis. Special \$10.43
Television IF coil Kits, includes 10 matched I.F., Osc., Video I.F., Sound I.F., Discriminator Trans. Complete with diagram for each. Special \$4.95 ea.	PHONOGRAPH KIT, complete with all parts, motor, turntable, pickup and cabinet for use with above amp. Special \$10.95
Television data Manuals, Design and Construction of 5 or 7" Television Receiver. Your price \$1.75	Speaker Kit includes 5" alnico speaker and cabinet. Special \$4.58
DOUGLAS	MICROPHONE KIT, complete with stand and cable for use with amp. Special \$5.58
5 Tube A.C., D.C., Superhet Kit, Model 500 with tone control. Complete with chassis, cabinet and all parts, less tubes. Your special price \$13.93	SPECIAL 12" G.E. 6.8 oz. alnico magnet Speaker. Your price \$7.45
Detroit Automatic Record Changer—changes 12-10" or 10-12" records. Special \$13.95	RESISTOR KIT, 100 asst. 1/4, 1/2, 1, 2 watt sizes. Your price \$1.95
Vertrol Noise Reducing Antenna for communications, broadcast and short wave receivers, Model 102-103 complete. List \$11.00. Your cost \$5.50	1/2 meg. Volume control and switch. Special 49c
	Variable Condenser for Superhet. Special \$1.10
	Variable Condenser for T.R.F. Special \$1.25
	Plastic Pliers, 5000 volt breakdown. Ideal for hot work. List \$1.50. Special 75c

TUBES—COMPLETE LINE OF ALL HARD TO GET TUBES, SEND US YOUR ORDER AND WE WILL SURPRISE YOU WITH PROMPT DELIVERY AT DISCOUNT PRICES

If it's hard to get—we have it!!

25% Dep. on C.O.D. Send for Free Catalog BA 7-3956 Add Postage under \$5.00
DOUGLAS RADIO SUPPLY CO.
DEPT. A. 128 GREENWICH STREET NEW YORK, N. Y.

NEWS ABOUT

THE LATEST IN RADIO PARTS—EQUIPMENT—ELECTRICAL DEVICES—brought to you in our monthly bulletins. ABSOLUTELY FREE! No obligation.

WRITE TO
MANUFACTURING DIVISION
HERBACH & RADEMAN, INC.
ELECTRONICS SPECIALISTS
522 MARKET ST., PHILA. 6, PA. • DEPT. B

Do you need BINDING POSTS?



The XL PUSH POST with its Spring Action assures Constant Contact and quick connection. Manufactured in All Aluminum Type M at 12c each. Aluminum Body, Bakelite Top Type B1 at 15c each. Types CP or NP. ALL BRASS—STAINLESS STEEL SPRING & PIN. PROVEN by 240 HR. SALT SPRAY TEST as NON-CORROSIVE at 28c each. Manufacturers and Dealers Liberal Discounts

X. L. RADIO LABORATORIES
420 West Chicago Ave., Chicago 10, Ill.

PEN-OSCIL-LITE

Extremely convenient test oscillator for all radio servicing. alignment. Small as a pen. Self powered. Range from 700 cycles audio to over 600 megacycles u.h.f. Output from zero to 125 v. Low in cost • Used by Signal Corps • Write for information.

GENERAL TEST EQUIPMENT
38 Argyle Ave. Buffalo 9, N. Y.

LCETI

An intercommunicator substation in a display window and connected to the master station near the work bench will pick up comments from prospective customers. This advance information is helpful, as it will give you a clue to possible sales resistance. Many other reactions will be heard and can be used to advantage in future sales and service.—*Low Buss*

FREE! Send for it NOW!

ALLIED'S 164-PAGE RADIO CATALOG



RADIO'S MOST COMPLETE BUYING GUIDE!

LARGEST STOCKS

SPEEDY, EXPERT SERVICE!

Send for your FREE copy of the most complete Buying Guide for Everything in Radio. Features thousands of radio and electronic parts, latest home radios, sound systems, amateur gear, builders' kits, servicemen's equipment, tools, books—world's largest stocks of quality equipment—all at lowest prices! Expert help; fastest service!



More than 10,000 items—Complete lines of all leading makes. Largest stocks of hard-to-get parts. Lowest money-saving prices. Get everything you need in Radio from ALLIED!



Public Address—entirely new line—new styling, new design features. Packaged Ready-to-Use Sound Systems; everything in amplifiers, speakers, mikes, intercom and recording.



Amateur Gear—immediate delivery on latest communications receivers. Time payment plan; trade-ins accepted. Headquarters for all ham and experimenters' needs.



Handy Radio Books
 Radio Formulas and Data Dictionary of Radio Terms
 Radio Circuit Handbook
 Radio Builder's Handbook
 Simplified Radio Servicing
 Radio Data Handbook
 ALL SIX BOOKS No. 37-799 . . . \$1.00
 Parallel Resistance and Series Capacitance Calculator. No. 37-960 . . . 25c
 R-F Resonance and Coil Winding Calculator. No. 37-965 . . . 25c

ALLIED RADIO

ALLIED RADIO CORP.
 833 W. Jackson Blvd., Dept. 2-H-7 Chicago 7, Ill.

Send FREE Radio Catalog
 Send 6 Books No. 37-799
 Send Calculator No. 37-960
 Send Calculator No. 37-955 } enclosed

Name.....

Address.....

City.....Zone.....State.....

Communications

CRYSTRON CONSTRUCTOR'S PROBLEM

Dear Editor:

We are having some difficulty in securing either U-235 or plutonium to complete *Crystron* tubes. Groves insists that the Manhattan Project is behind schedule on these products, and cannot supply them in the near future.

Also, since working on that first tube, people can see me glow in the dark. Please send information I can use to de-radioactivate myself, or at least to turn myself off at night! I can't sleep in the light.

Please read all communications from me under leaded glass, or else through a periscope. Decontaminate your building after having sent my letters to the Roentgenologist at the local hospital.

Am forwarding a Geiger counter under separate cover.

Yours energetically,
 BRUCE THOMAS,
 Ocean Springs, Miss.

(We have put several persons to work on this important problem. At present they are searching the literature for references on a material used in experiments on *contrapolar frequencies*. It has the peculiar characteristic that it casts no shadow, except in complete darkness, and it is believed that a suit of pajamas of this material may clear up Mr. Bruce's difficulties. Any assistance our readers give us on this problem will be appreciated.—Editor)

AFTER ABSOLUTE ZERO, WHAT?

Dear Editor:

I have just read your editorial, "Superadio," in the April RADIO-CRAFT and enjoyed it very much. Please accept my thanks for passing on such sparks of stimulating data to those of us who have become somewhat distantly removed from the heart of such developments.

Since the local reference texts are quite limited here (Maile, Oahu), I have taken the liberty of writing you concerning this editorial.

The phenomena of decreased electrical resistance with a decrease in temperature—and its possible limits—have always fascinated me. For example, there is the case of the German physicist who set up an oscillatory current in a tuned circuit that was cooled nearly to absolute zero, flew the entire setup to England from Germany, delivered a lecture and demonstration showing easily detectable current to be still flowing at the end of the lecture, no energy having been furnished the circuit other than the original charge on the condenser. It has been a phenomena which, as a former instructor, I was called upon to explain many times.

It was my final conclusion that the energy (heat) contained in a piece of metal, for example, was stored in the movements of electrons (to put it very briefly and roughly) and that this energy could be given up by these electrons under proper conditions. The releasing of this energy results in a decrease in electrop activity, making the work necessary to move them from their established locations easier. As this activity progressively decreases with decreases in temperature, the electrons can be moved with the expenditure of less and less energy. At absolute zero, there being absolutely no energy left in the metal, there would be an equivalent amount of energy required to move an electron from its immediate location (i.e., unre-

gainable energy) or zero energy and hence the conductor would exhibit the phenomenon of zero resistance.

But, if absolute zero were actually reached? I will take the liberty to say that we are all interested. I believe that the material so stripped of *all* of its energy would simply disintegrate, there being no force to hold it together—or am I correct, according to accepted data, in the assumption that absolute zero has never been reached? Or am I possibly using a definition of absolute zero different from that generally accepted?

I do not have any of my texts here that will assist me in considerations of these details, hence I would appreciate further comment from your technical staff or, if possible, from you.

I should like to compliment you on your World-Wide Station List.

HERBERT L. WEST,
 Sr. Trans. Eng., KRHO,
 Maile, Oahu, Hawaii

(Professor Kamerlingh Onnes, the famed Dutch research scientist who was the first to demonstrate superconductivity many years ago, was of the opinion that if it were possible to go down

"CRYSTAL GAZING"



Cartoon by Franklin Folger

to absolute zero, then a current once started (such as by induction) in any closed circuit would continue perpetually. This would not be any more perpetual motion than the planets moving around the sun perpetually, but probably would come under the same classification.

Whether it is possible ever to go down to the absolute zero is something that cannot be predicted now, but many physicists think it is doubtful, at least

according to our knowledge of physics.

Whether material cooled to absolute zero will disintegrate at such a temperature is also something that no one knows until it has actually been tried. What phenomena will emerge and become known if absolute zero is reached is something that seems difficult to predict fully. There are too many factors unknown at present and we still know too little about the atom as well as the electron to make any actual prediction today.—*Editor*)

MORE AMPLIFIER HOOKUPS, PLEASE

Dear Editor:

I notice that you have in your latest issue a letter complaining about too many amplifier diagrams.

These are the very items I am interested in—and have been for a long time. I have built up an amplifier similar to the one you featured a few months ago in connection with a small recording studio. It varies from the original mainly by incorporating means for operating 2 standard 35-mm projectors, as it is designed for use as a theater am-

plifier. I also have a medium-size reflex baffle built from your specifications but using a dividing network for the high- and low-frequency speakers, which I find makes a vast difference in results. The response is flat from 50 to 10,000 cycles, and I mean flat.

I am a graduate of *de Forest Training*—and a regular theater projectionist. I find the training I have had and your circuit information a big help in designing this type of equipment.

JAMES A. LEVETT,
Delhi, Ontario

AIRBORNE METAL SEEKER

(Continued from page 73)

presence of normal background noise. Prior to the development of the magnetometer, measurements of this sensitivity required magnetometers mounted on a stable base and incorporating quartz-fiber suspensions.

With airborne equipment it is obviously difficult to maintain the magnetometer in fixed orientation, and any change in orientation would give very large signals which would mask those caused by the presence of a submarine. The Bell Telephone Laboratories therefore, at the request of the National Defense Research Council, worked out a practical means for keeping the magnetometer in a fixed orientation.

The magnetometer is least sensitive to angular motions when it is in line with the earth's magnetic field, and it was therefore decided to hold the detecting magnetometer in this position. To maintain such an alignment, two other magnetometers operating through servo mechanisms are used to position an assembly that contains all three magnetometers. This assembly is supported in gimbals in the manner of a marine compass, but it is provided with mechanical drives that, under control of the servos, can rotate it on each of the two gimbal axes. The three magnetometers are all at right angles to each other similar to the x- y- and z-axes of a rectangular coordinate system. The magnetometer to be used as the detector, which may be considered as that along the x-axis, is held in the direction of the earth's magnetic field while the other two—used for operating the servo motors—are at right angles to it along the y- and z-axes. This right angle position is the most sensitive to angular changes, and thus a very small change in the alignment of the detector magnetometer with respect to the field will

cause a signal to appear in one or both of the control magnetometers that can be used to return the assembly to the correct position. The motors, because of the magnetic materials required in their construction, are of minimum size and are placed about 2 feet from the magnetometers.

The complete magnetometer assembly, including the gimbal mount and the driving motors, is mounted on a framework which must be placed in a position where it will not be unduly affected by the magnetic parts of a plane. On some large planes, such as the PBY patrol bomber, a suitable location was provided in the form of a plywood tail extension. When working with smaller planes it has been necessary to place the unit in a streamlined housing called a bird, which may be carried behind and below the plane by means of a towing cable.

Besides this unit, which is known as the orienting mechanism, an oscillator is required to provide the a.c. excitation for the magnetometers, and an amplifier and detector to transform the signals produced by the magnetometers into signals suitable for operating the servos and the indicating and recording instruments. The oscillator and the amplifier detector are mounted on separate chassis in a single case. Required in addition are a dynamotor unit as a power supply, a control unit used in operating the apparatus, a recording meter, and one or two remote indicators.

The Navy has already made several surveys—both for oil and magnetic materials—and the results indicate that aerial magnetic surveying will be of great value, not only to those engaged in locating mineral deposits, but also to geologists and students of terrestrial magnetism.

NOW AVAILABLE!
Full Range Reproduction



A revolutionary development in amplifiers cleverly designed to defy obsolescence and amazing in its performance. New circuits, new materials and new processes are actually combined in this one amplifier to produce the most satisfying musical amplifier the world has ever known. If you are one of those discriminating persons for whom anything less than the best is a disappointment, you are one for whom the ACA-100DC was designed. Send for technical literature.

AMPLIFIER CORP. of AMERICA

398 Broadway, New York 13, N. Y.

WHAT STRANGE POWERS
Did The Ancients Possess?

WHERE was the source of knowledge that made it possible for the ancients to perform miracles? These wise men of the past knew the mysteries of life and personal power. This wisdom is not lost—it is withheld from the masses. It is offered freely TO YOU, if you have an open mind. Write for free sealed book. Address: Scribe F.X.S.

The ROSICRUCIANS
San Jose (AMORC) California

A.C. CURRENT ANYWHERE!

With Katolight Plants and Generators Furnish the same kind of Current as the highlines. Sizes 500 watts to 100 KW. Also Manufacturers of Rotary Converters, Frequency Changers, 32 and 110 Volt D.C. Motors, in 1/2, 1/3 and 1/2 H.P. A.C. Motors, single phase in 1 1/2 and 2 H.P. only.

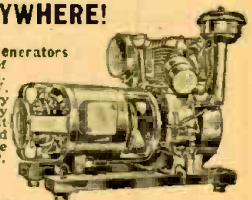

KATOLIGHT
120 Rock St., Menkato, Minn.

TUBULAR ELECTROLYTICS

Fresh stock Fully guaranteed

20 mfd. 150 V.	10 for \$1.79
20-20 mfd. 150 V.	10 for 2.49
8 mfd. 450 V.	10 for 1.85

Postage extra. 25% deposit on COD.
Write for our free bargain lists featuring "AMERICA'S BEST BUYS"

POTTER RADIO CO.

1312-1314 McGee St. Kansas City 6, Mo.

ROTA-BASE

NEW HANDY LAB. DIAL actually gives a "prong" picture of radio tube connections. Simply turn the dial to the tube number desired on the ROTA-BASE and complete correct connections are instantly indicated on the "prong" diagram. No more valuable time lost thumbing pages or on lengthy readings. Filament, grid, plate, cathode, etc., to MORE THAN 300 tube types are given. PRICE NOW ONLY \$1.00 postpaid or sent C.O.D. plus postage. Order NOW, money refunded if you are not delightedly pleased.

REED MFG. CO. 411 S. Main St. Los Angeles 13, Calif.

YOUR RADIO JOBBER SELLS

Supreme Publications

DIAGRAM MANUALS, INSTRUCTION BOOKS

See your jobber or write for catalog.

SUPREME PUBLICATIONS, Chicago 12, ILL.

AUGUST LEOTONE SPECIALS

Push Button Assembly, 5 position, D.P., circuit transfer, 5" long 1 1/2" deep, 3/4" shafts. .69
With set of 5 matched bakelite knobs. .95

SPECIAL!! GIANT "GRAB-BAG" RADIO PARTS KIT. A real buy for the Serviceman, Amateur or Experimenter. 15 FULL POUNDS of resistors, condensers, transformers, wire, speaker repair parts, hardware, etc., etc. An amazing value at **1.95**

Bendix Amplifier (Line of Sixt Rotary Indicator) 115V, 400 cycles. Contains: Power Trans., 3 audios, 6 oil condensers plus other components worth many times the price. Black crackle case. 7"x5 3/4"x4". Shpg. wt. 9 lbs. **1.95**

UTC "OUNCER" INPUT TRANSFORMER (3 1/2"x1 3/16"). Dynamic, mite or low impedance pick-up to grid. Pri. Imped: 50 ohms. .49c ea.; 12 for 5.00

HEADPHONES (Army HS-23) 8000 ohms Imped. Leather covered adjustable. With PL-54 plug. .125
Rubber Phone Cushions for above, per pair. .39
HEADBANDS (HS-7) with PL-54 dbie cord PL-54 plug & 13" tipped dbie cord. .19
JK-26 ext. jack for PL-54. .23

SERVICEMEN'S KITS

- #1-R.F., Ant. & Osc. coils 10. asstd. .98
- #2-Speaker Cones: 12 asstd. 4" to 1 1/2" moulded & iron-edge (magnetic incl.) Less voice coils. 2.00
- #3-Moulded BAKELITE CONDENSERS. 50 asst. .00001 to .2mfd, 200-600V. 2.95
- #4-TUBULAR BY-PASS CONDENSERS. 50 asst. .001 to .25mfd, 200-600V. Standard brands. 2.49
- #9-Water Socket; 12 asstd. 4 to 7 prongs. .25
- #11-Shield Can; 15 asstd. for coils, tubes, transformers, etc. 1.00
- #12-Misc Padders & Trimmers: 15 asstd. incl. multiple & ceramic base types. .69
- #14-Volume & Tone Controls: 10 asstd. wire-wound & carbon. Less switches. 1.49
- #15-Wire-Wound Resistors: 15 asstd. ohms, 5 to 20 watts. .98
- #16-Bakelite Coil Form; 18 asstd. popular sizes up to 3" diameter. .98
- #10-High Resistance Units: 25 asstd. carbon & wire. Ferrule-end. 25k to 5 meg. .49
- #21-Metal Cased By-Pass Condensers: 10 asstd. paper-wound, multi-section. 200-400V. .49
- #22-Resistor Assortment: 20 carbon & wire-wound, asstd. ohms, 1/3 to 3 watts. .49
- #23-RADIO CEMENT & SOLVENT: 3 oz. each of all purpose cement & thinner. With brush. .69
- #24-Shaft Extenders, Reducers, Couplings: 10 asstd. popular types used in servicing. 1.29
- #25-Spring Assortment: 60 asstd. compression & expansion for dials, push-buttons, relays, etc. .98

TUBES: Perfect condition, but not in sealed cartons. Every tube guaranteed 90 days.
#20, 26, 27, 48 or 50 .29
#42, 45, 74, 75, 80, 89, 5Y3, 6H6 or 6K7 .39
#35, 39, 76, 84, 6A8, 6C5, 6F5, 6SK7 or 12SK7 .49
#147, 6A3, 6U5, 7A7, 7C6 or 50 .59

ALNICO MAGNETS

- #1-Flat bar, 3/4"x5/16"x1/8" .59
- #2-Flat bar, 1/4"x3/8", lengths up to 4". Per inch. .12
- #3-Face 1 1/4"x1 3/4"x3/8" high. .98
- #4-Heavy duty bar, 2 1/2"x1 3/8"x5/16". .98
- #5-Face 3/4"x3/8"x3/8" high. .39
- #6-Polished, 7/8"x20/16"x3/8" high. .35
- #7-Face 1 1/2"x1 1/2"x3/8" high. .10
- #9-ALNICO V. h. shoe, poles 9/16" sq.; 1 1/2" high. .98
- #11-h shoe, poles 1-1/16" O.D. 2 1/4" high. 1.29
- #14-Polished bar, 3"x1 1/4"x3/8" (magnetized lengthwise, wide or narrow sides). 1.29
- #16-Flat bar, 1 1/2"x1 1/2"x5/16" thick. .49
- #18-Round bar, 1/2" O.D., 1 1/2" long. .19
- #20-Round bar, 1/2" O.D. (3" max). Per inch. .07
- #22-Round bar, pol. 3/8" O.D. 1 1/2". .39
- #24-Round bar, pol. 3/8" O.D. 2" long. 1.25
- #26-Round bar, pol. 3/8" O.D., 2" long. .39
- #27-Polished Block 3/4"x3/4"x3/8". .39
- #28-Circular, pol. 1 1/8" O.D. 13/16" I.D. 1 1/2" deep. 1.95
- #29-Circular, pol. 2 3/8" O.D. 1 3/8" I.D. 1 1/2" deep. 1.65
- #30-h shoe, facing 3/8" sq. poles, 3/4" gap, 2 1/4" high. .89
- #31-h shoe, extremely powerful. Poles 15/16"x13/16", polished. 2" high. 1.49

DYNAMOTOR (DM-38-D) 28V. DC to 220V. DC @ 80 ma. With complete filter system. 6 1/2"x4 3/4"x3". Shpg. wt. 7 lbs. 110V. AC quiet film-drive, fan cooled. With 9" turntable. 2.95

TWIN-COIL PHONO MOTORS. 110V. AC quiet film-drive, fan cooled. With 9" turntable. 2.95

RADIO HARDWARE TREASURE. An indispensable assortment of approx. 1000 screws, nuts, washers, lugs, etc. .49

EXPERIMENTAL TUBES. 60 asstd. receiving types for testing, research, etc. Filament tested. 1.00

PROMPT SERVICE ON ALL SPEAKER & PHONO PICK-UP REPAIRS
Minimum Order \$2.00-20% Deposit Required on orders. Please Add Sufficient Postage. Write RC-B.



LEOTONE RADIO CO.
MAKERS OF CONES AND FIELD COILS
65-67 DEY STREET, NEW YORK 7, N.Y.
WORTH 2-0284-5
12,000 SQ. FT. OF RADIO PARTS

INDEX TO ADVERTISERS

Abell Distributing Company	62	National Radio Institute	1
Brodix Advertising Agency	70	Van Sant, Dugdale & Co.	9
Alamo Radio Sales	80	National Schools	9
Altomari Advertising Agency	80	The Mayers Company	69
Allied Radio Corporation	71, 81	Newark Electric Company, Inc.	69
George Brodsky Corporation	71, 81	Bergman-Jarrett	65
Amplifier Corporation of America	71, 81	Niagara Radio Supply	65
H. J. Gold Co.	11	Bergman-Jarrett	67
American Television, Inc.	11	Olson Radio Warehouse	67
Turner Advertising Agency	71	Jessop Advertising	77
Apex Video Company	61	Opportunity Adlets	77
Anderson & McConnell Advertising	61	Potter Radio Company	81
Walter Ashe Radio Company	61	Precision Apparatus Company	77
Ralph W. Smith Advertising Agency	83	Shappe-Wikes, Inc.	78
Audel Publishers	6	Progressive Electronics Company	78
Grant & Wadsworth, Inc.	47	Thomson, Sava & Valenti, Inc.	
Bell Telephone Labs.	64		
N. W. Ayer & Son	79		
Bonded Electronics Company	8		
Sternfield-Godley	72		
W. H. Brady Company	75		
Brady-Parkinson Company	79		
Brooks Radio Distributing Company	8		
Equity Advertising Agency	72		
Buffalo Radio Supply	75		
International Advertising Agency	79		
Burstein-Applebee Company	15		
Frank E. Whalen Advertising Company	13		
Buyers' Syndicate	12		
C. F. Cannon Company	59		
M. J. Werner Advertising	70		
Capitol Radio Engineering Institute	72, 74		
Henry J. Kaufman & Associates	78		
Cleveland Institute of Radio Electronics	68		
Kenneth Kolpein Advertising	76		
Communications Equipment Company	50		
Borough Advertising Agency	70		
Concord Radio Corporation	70		
E. H. Brown Advertising Agency	70		
Coyne Electrical School	70		
Phil Gordon Advertising Agency	70		
Coyne Electrical School	70		
Gordon Best Company, Inc.	70		
DeBaugh Company	70		
Deer & Taylor	70		
Spencer W. Curtiss Advertising	70		
DeForest's Training Institute	70		
Lauesen & Salomon	70		
Douglas Radio Supply Company	70		
Electronic Distributors, Inc.	70		
Campbell, Reynolds & Evans	70		
Fair Radio Sales	70		
Acorn Advertising Agency	70		
General Cement Mfg. Company	70		
Sander Rodkin Advertising Agency	70		
General Electronic Distributing Company	70		
Bass & Weber Company, Inc.	70		
General Test Equipment Company	70		
Suzanne Hayman Advertising	70		
Herbach & Rademan, Inc.	70		
Philipp Klein Advertising Agency	70		
Hershel Radio Company	70		
Hugh Allen Company	70		
Highbridge Radio-Television & Appliance Co.	70		
Bergman-Jarrett	70		
Hudson Specialties	70		
Instructograph Company	70		
Turner Advertising Agency	70		
International Resistance Company	70		
John Falkner Arndt & Company, Inc.	70		
Katolight Company	70		
Lafayette Radio	70		
Reiss Advertising Agency	70		
Leeds Radio Company	70		
Weber Associates	70		
LeJay Manufacturing Co.	70		
Frizzell Advertising Agency	70		
Leotone Radio Corporation	70		
Altomari Advertising Agency	70		
McMurdo Silver Company	70		
Edward Owen & Company	70		
P. R. Mallory & Co., Inc.	70		
Aitkin-Kynett Company	70		
Maritime Switchboard	70		
Mission Radio	70		
Murray Hill Books Company	70		
Harry P. Bridge Advertising	70		
National Plans Company	70		

RADIO SCHOOL DIRECTORY

(See Page 84)

American Radio Institute	
Sternfield-Godley Inc.	
Baltimore Technical Institute	
Candler System Company	
Rand-Ries Advertising	
Commercial Radio Institute	
Don Martin School of Radio Arts	
Hollywood Sound Institute	
Nelson Advertising Service	
Lincoln Engineering School	
Buchanan-Thomas Advertising	
Melville Radio Institute	
Seidell Advertising	
Milwaukee School of Engineering	
Kalu-Van Pieterston-Dunlap Associates	
RCA Institutes	
Tri-State College	
Clem J. Steigmeyer Advertising	
Western Radio Communications Institute	
Radcraft Publications	43, 49, 50
Radio Center	57
Claude E. Whipple Advertising	
Radio Corporation of America	2
J. Walter Thompson Company	
Radio Dealers Supply Company	71
Radio Kits Company	68
Hamburger Agency	
Radionic Equipment Company	66
Republic Advertising Agency	
Radio Publications	76
Radio Supply and Engineering Company	16
Karl G. Behr Advertising Agency	
Radolek Company	65
Campbell, Reynolds & Evans	
Reed Manufacturing Company	81
Borg Advertising Agency	
The Rosicrucians	81
Richard Jorgensen Advertising	
Howard W. Sams and Company, Inc.	4
George Brodsky	
Walter L. Schott Company	78
Ross, Gardner & White	
Sprayberry Academy of Radio	5
Harry P. Bridge Company	
Standard Electronics Distributing Co., Inc.	63
The Signet Corporation	
Sterling Electronic Company	66
Supreme Publications	81
Henry H. Teplitz Advertising	
Sylvania Electric Products, Inc.	Back Cover
Newell-Emmett Company	
"TAB" Technical Apparatus Bldrs.	73
Weber Associates	
Television Assembly Company	51
Sternfield-Godley, Inc.	
Telex, Inc.	Inside Back Cover
Campbell-Mithun, Inc.	
Tiret Electric Company	78
Transvision, Inc.	45, 75
H. J. Gold Company, Adv.	
U.H.F. Resonator Co.	72
Wright, Inc.	71
Kay Advertising, Inc.	
X. L. Radio Laboratories	79

THE QUESTION BOX EDITOR HAS A PROBLEM

The radio serviceman-dealer is not the only one who has to listen patiently while customers complain that no moisture appears at the grid leak, or have to translate when someone comes in to ask for a microfarad. The radio editor sometimes runs afoul of one of these evil geniuses, as witness the following letter, sent to our own Question Box:

Dear Sir:
How can I take out the redness of the Sparton No. 483 or 171A 5 volts

fil power tubes they had a wet electrocycle condenser made the rect tube shorted so I put in a dry one that is working all right as soon you put in one socket it start again one tube not do that I think I need a 1250 ohm resistor in C bias in push pull amp. do I need the R5 15,000—5 watts in the between the push pull audio transformer and speaker connection marked B. This set does not use a hum control.

Yours Truly

BOOK REVIEWS

TELEVISION RECEIVING EQUIPMENT (Second edition), by W. T. Cocking, M.I.E.E. Published for "Wireless World" by Hiffe & Sons, Ltd., London, England. Stiff cloth covers, 4¼ by 7 inches, 354 pages with 3 large fold-in diagrams. Price 12/6d.

This book is the postwar edition of one of the leading television texts in Great Britain. The author, editor of *Wireless World* and *Wireless Engineer* magazines, has presented this material in the concise, well-illustrated style that will be familiar to many readers of his magazines. Prepared for the British television technician, the book will be equally useful to American engineers who are able to make allowances for the differences in American and British television techniques.

The first three of twenty-two chapters are devoted to a general discussion of television principles. Fourteen of the following chapters deal with circuits and their applications in television receivers. The concluding chapters cover the complete receiver and television servicing. An 11-page appendix gives a brief mathematical treatment of integrators, differentiators, and d.c. restoration.—*R.F.S.*

ELECTRONIC ENGINEERING PATENT INDEX. Edited by Frank A. Petraglia. Published by Electronics Research Publishing Co., New York, N. Y. Stiff covers, 7 x 10 inches, 476 pages. Price \$14.50.

This volume is the first of a series to be published annually. It lists approximately 2,000 electronic patents issued during 1946. Each is described just as it is in the *Patent Gazette*, including the inventor's name, patent drawing, and one claim. Each patent appears under one of 93 headings (bridges, oscilloscopes, recorders, etc.). Within each

group, the patents are listed by issue number.

With the continued rapid progress in the electronic field, designers and engineers will find that this patent index meets a real need.—*I.Q.*

ELECTRONS (+ and -), PROTONS, PHOTONS, NEUTRONS, MESOTRONS, and COSMIC RAYS, by Robert A. Millikan. Published by the University of Chicago Press. Stiff cloth covers, 5 x 7½ inches, 642 pages. Price \$6.00.

Written by the Nobel Prize winner, Robert A. Millikan, this is an excellent work for the general student. It provides a nonmathematical treatment of the structure of the atom, plus the latest studies of the release and utilization of nuclear energy, geomagnetic investigations, and cosmic rays. Other live subjects covered are the nature of cosmic rays and the atom-annihilation hypothesis for the origin of cosmic rays.

The first part of the book describes early concepts of the nature of electricity, conduction in gases, the atomic nature of electricity, determining the exact value of the charge on the atom, etc. Later Dr. Millikan discusses the nature of radiant energy, waves and particles, the spinning electron, discovery of the cosmic ray, the positron, the neutron, nuclear energy, and geomagnetic studies in cosmic rays.

The mesotron receives a lengthy treatment, as do primary incoming rays, with a description of their detection and measurement. The closing chapters deal with the atom-annihilation hypothesis, including results of measurements of cosmic rays in various parts of the world. The appendices at the end of the book will prove valuable to earnest students of the subject. They include the determination of "e," the Brownian movement equation, the mass of an electrical charge on a sphere, molecular cross section and mean free path, table of the elements and their atomic numbers, etc. A very complete author and subject index is included.—*H.W.S.*

ELECTRONS IN ACTION, by James Stokley, General Electric Research Laboratory. Published by Whittlesey House, McGraw-Hill Book Company. Stiff cloth covers, 5½ x 8½ inches, 309 pages. Price \$3.00.

This book is a non-technical approach to the study of the electron and its effects on our everyday lives. Fifty-four drawings, sketches and diagrams illustrate the subject graphically, and are supplemented by 44 photographs.

Radio and television are discussed in the order of their chronological development, from the earliest attempts to carry information through space without wire to the present schemes for color television. To describe interlaced scanning, the lines of the page on which it is described are numbered in the same sequence as they would be scanned, and

(Continued on page 84)

READ FOR PROFIT

Just Out!

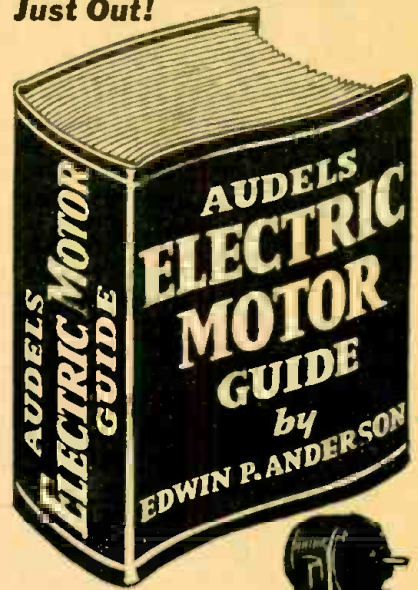

1000 PAGES OF PRACTICAL MOTOR INFORMATION

AUDELS ELECTRIC MOTOR GUIDE covering the construction, hook-ups, control, maintenance and trouble shooting of all types of motors including armature winding. Explains entire subject in every detail. 31 Chapters, 617 Illustrations & Diagrams.

A Handy Guide, Fully Indexed for Electricians and all Electrical Workers.

\$4 COMPLETE • PAY ONLY \$1 A MONTH

Step up your own skill with the facts and figures of your trade. Audels Mechanics Guides contain Practical Inside Trade Information in a handy form. Fully illustrated and Easy to Understand. Highly Endorsed. Check the book you want for 7 days Free Examination.

Send No Money. Nothing to pay postman.

CUT HERE
MAIL ORDER

AUDEL, Publishers, 49 W. 23 St., NEW YORK 10, N. Y.

Please send me postpaid for FREE EXAMINATION books marked (X) below. If I decide to keep them I agree to mail \$1 in 7 Days on each book ordered and further mail \$1 monthly on each book until I have paid Price. Otherwise, I will return them.

- ELECTRIC MOTOR GUIDE, 1000 Pages . . . \$4.
- ELECTRICIANS EXAMINATIONS, 250 Pages . . . 1.
- WIRING DIAGRAMS, 210 Pages . . . 1.
- ELECTRICAL DICTIONARY, 9000 Terms . . . 2.
- ELECTRICAL POWER CALCULATIONS, 425 Pgs. . . 2.
- ELECTRONIC DEVICES, 216 Pages . . . 2.
- RADIOMANS GUIDE, 914 Pages . . . 4.
- HANDY BOOK OF ELECTRICITY, 1340 Pages . . . 4.
- ELECTRIC LIBRARY, 12 vol., 7000 Pgs., \$1.50 vol. . . 1.
- OIL BURNER GUIDE, 384 Pages . . . 1.
- REFRIGERATION & Air Conditioning, 1280 Pgs. . . 4.
- POWER PLANT ENGINEERS Guide, 1500 Pages . . . 4.
- PUMPS, Hydraulics & Air Compressors, 1658 Pgs. . . 4.
- AUTOMOBILE GUIDE, 1540 Pages . . . 4.
- DIESEL ENGINE MANUAL, 400 Pages . . . 2.
- WELDERS GUIDE, 400 Pages . . . 1.
- BLUE PRINT READING, 416 Pages . . . 2.
- SHEET METAL WORKERS Handy Book, 388 Pgs. . . 1.
- SHEET METAL PATTERN LAYOUTS, 1100 Pgs. . . 4.
- AIRCRAFT WORKER, 240 Pages . . . 1.
- MATHEMATICS & CALCULATIONS, 700 Pgs. . . 2.
- MACHINISTS Handy Book, 1600 Pages . . . 4.
- MECHANICAL Dictionary, 968 Pages . . . 4.
- MARINE ENGINEERS Handy Book, 1280 Pages . . . 4.
- MECHANICAL DRAWING GUIDE, 160 Pages . . . 1.
- MECHANICAL DRAWING & DESIGN, 480 Pgs. . . 2.
- MILLWRIGHTS & Mechanics Guide, 1200 Pgs. . . 4.
- CARPENTERS & Builders Guides (4 vols.) . . . 6.
- PLUMBERS & Steamfitters Guides (4 vols.) . . . 6.
- MASONS & Builders Guides (4 vols.) . . . 6.
- MASTER PAINTER & DECORATOR, 320 Pgs. . . 2.
- GARDENERS & GROWERS GUIDES (4 vols.) . . . 6.
- ENGINEERS and Mechanics Guides . . . 12.
- Nos. 1, 2, 3, 4, 5, 6, 7 and 8 complete . . . 1.
- Answers on Practical ENGINEERING . . . 1.
- ENGINEERS & FIREMANS EXAMINATIONS . . . 1.

Name _____

Address _____

Occupation _____

Employed by _____ RCF

RADIO TERM ILLUSTRATED



Suggested by: Gilberto Garza G(Xelga), Mexico

Overloaded Capacity

RADIO-CRAFT for AUGUST, 1947

RADIO SCHOOL DIRECTORY

PREPARE NOW FOR SKILLED JOBS IN RADIO AND ELECTRONICS

CAREERS in RADIO

INTENSIVE COURSES—Thorough, technical education for progressive men and women.

1. **RADIO TECHNICIAN**—The MRI General Course. Includes F.M. & Television. Prepares for FCC Broadcast Licenses.
2. **RADIO & TELEVISION SERVICING**—Prepares for employment as Repairman on Standard Broadcast, F.M. & Television Receivers.
3. **RADIO COMMUNICATIONS**—Prepares for FCC Operators' License. Leads to position as Merchant Marine or Flight Radio Officer; Commercial Operator.
4. **FUNDAMENTAL RADIO MATHEMATICS**—The MRI Preparatory Course. Required pre-training for students lacking a basic mathematical background.

MELVILLE RADIO INSTITUTE

MELVILLE BUILDING
15 WEST 46TH ST., N. Y. 19. BR 9-5080
"The Radio School Managed By Radio Men"

Licensed by the State of New York

MELVILLE RADIO INSTITUTE

MELVILLE BUILDING
15 West 46th St., N. Y. 19, N. Y.

GENTLEMEN: RC
Send me FREE information about your school.

Name.....

Address.....

MAIL THIS COUPON NOW

WRCI ELECTRONICS

graduates now flying with transoceanic airlines, working in broadcast stations, operating their own radio service business. The technical staff and laboratory facilities of WRCI provide superior practical training with modern laboratory equipment. No time wasted on non-essentials. Small classes—uncrowded facilities. Specialized training in RADIO-TELEVISION SERVICING and in RADIO OPERATING. Beginners' classes start monthly. Quota for non-veterans. Approved for veterans. Member L. A. Chamber of Commerce. Free copy of "Lifetime Careers in Radio-Electronics" upon request. WESTERN RADIO COMMUNICATIONS INSTITUTE, 631 W. 9th St., Los Angeles 15, Cal.

RADIO

TECHNICIAN and RADIO SERVICE COURSES
FM and TELEVISION

AMERICAN RADIO INSTITUTE
101 West 63rd St., New York 23, New York
Approved Under GI Bill of Rights
Licensed by New York State

CODE SENDING SPEED

Be a "key" man. Learn how to send and receive messages in code by telegraph and radio. Commerce needs thousands of men for jobs. Good pay, adventure, interesting work. Learn at home quickly through famous Candler System. Write for FREE BOOK.
CANDLER SYSTEM CO.
Dept. 3-J, Box 928, Denver 1, Colo., U.S.A.

COMMERCIAL RADIO INSTITUTE

A radio training center for 27 years.

RESIDENT COURSES ONLY

Broadcast, Service, Aeronautical, Television and Marine telegraphy classes; Preparatory Course now forming. Literature upon request. Veteran training. Classes now forming for October 1st.
Dept. C, 38 West Biddle St., Baltimore 1, Md.



RCA INSTITUTES, Inc.

Offer thorough training courses in all technical phases of **Radio and Television**

DAYS—EVENINGS WEEKLY RATES
VETERANS: RCA Institutes is approved under G. I. Bill of Rights

For Free Catalog Write Dept. RC-47

RCA INSTITUTES, Inc.

A Service of Radio Corporation of America
75 VARICK STREET NEW YORK 13, N. Y.

Radio Technician and Announcers

A practical 15-month course in First Class Radiotelephone Operation and Announcing is offered by Don Martin School of Radio Arts. Most stations these days require combination men. We specialize in this type of training and maintain a placement bureau for our graduates. Serving the industry for 10 years, the School of Radio Arts can train you. Write for our catalogue outlining the courses offered. Classes can be arranged so you can do part time work on the side.

APPROVED FOR VETERANS

DON MARTIN SCHOOL OF RADIO ARTS
1655 North Cherokee St. Hollywood 28, Calif.

LEARN

RADIO

Get F.C.C. License
RADIO — TELEVISION
Repairing

Classes start every month

Our organization engaged in **TECHNICAL TRAINING** for 27 Years
LITERATURE ON REQUEST

BALTIMORE TECHNICAL INSTITUTE
1425 Eutaw Place, Balto. 17, Md.

RADIO ENGINEERING!

Complete Radio Engineering Course, Bachelor of Science Degree. Courses also in Civil, Electrical, Mechanical, Chemical, Aeronautical Engineering; Business Administration, Accounting, Secretarial Science. Graduates successful. 64th year. Enter Sept., Jan., March, June. Write for catalog.

DEGREE IN 27 MONTHS

TRI-STATE COLLEGE 2487 College Ave. ANGLEA INDIANA

PRACTICAL TECHNICAL TRAINING FOR YOU

Specialize in Electronics, Radio, Electricity, Refrigeration, Heating and Air Conditioning, or Welding. Prepare in one year for position as Technician, or in two additional years secure your B. S. Degree in **ELECTRICAL ENGINEERING** with major in Machinery or Electronics.

Write for booklet "Career Building"

MILWAUKEE SCHOOL OF ENGINEERING

INSTITUTE OF ELECTRONICS
RC-847 N. Broadway and E. State, Milwaukee, Wis.

CORRESPONDENCE COURSES IN RADIO and ELECTRICAL ENGINEERING

ELECTRICAL ENGINEERING Get good grasp of wide electrical field. Prepare yourself at Low Cost, for secure future. Modern course. So simplified anyone can understand quickly.
RADIO ENGINEERING public address, photo-electric work. Trains you to be super-service man, real vacuum-tube technician. Servicemen needed badly. Diploma on completion. Many graduates earning big pay.
Send postcard for Free Copies of school catalog, full details, all about deferred payment plan, experimental kits, etc.
WRITE \$25 Either Course
Lincoln Engineering School, Box 931C-102, Lincoln 2, Nebr.

BOOK REVIEWS

(Continued from page 83)

the page can be read only by "interlaced scanning."

The easily understood presentations of Klystron and magnetron oscillators are particularly novel and interesting. Another interesting chapter is the one which discussed the effects of atomic and solar disturbances on transmission and reception of radio signals.

DUNCAN'S RADIO-ELECTRONICS DICTIONARY. Compiled by R. L. Duncan. Published by Radio-Electronics Publishing Co. Heavy paper covers, 5½ x 8½ inches, 106 pages. Price \$1.50.

A postwar product, this dictionary defines such new terms as *resatron* and *shoran*. Some of the definitions, however, show the effects of hasty preparation. An appendix includes a number of tables, graphs, and formulas of value to the radioman.

AUDIO OSCILLATOR

(Continued from page 72)

values shown, the tuning ranges are:

Range	Frequency (cycles)
1	12.5 to 25
2	25.0 to 50
3	50.0 to 100
4	100.0 to 200
5	200.0 to 400
6	400.0 to 800
7	800.0 to 1600
8	1600.0 to 3200
9	3200.0 to 6400
10	6000.0 to 12000
11	12000.0 to 24000

In the next installment of this article, Mr. Weiland will describe the construction and calibration of his oscillator.

LEARN NOW!

ELECTRONICS

- RADIO
- F.M. and TELEVISION
- PUBLIC ADDRESS SYSTEMS
- SHORT WAVE COMMUNICATIONS

Men! Women! Find successful careers in this fascinating field! Ample equipment for all to use in **practical** classes. You start practice when you enroll!

Approved for Veterans

HOLLYWOOD SOUND INSTITUTE

1040 N. Kenmore Ave., Dept. B
LOS ANGELES 27, CAL.

\$175 AND 25 MONOSETS GIVEN

To Winners of This

EASY CONTEST!

RADIO AMATEURS.

Just write 50 words or less telling us why you like the TELEX MONOSET better than old style earphones.



WIN:

\$100

and a MonoSet

\$25

and a MonoSet

\$50

and a MonoSet

PLUS

TELEX MONOSETS
to 22 Runner-ups!

HERE'S ALL YOU DO:

1. Go to your *parts jobber* and ask him to let you try out the revolutionary under-the-chin TELEX MONOSET.
2. In 5 minutes you'll get at least half a dozen good, WINNING ideas. Be sure to get *all* the facts and an OFFICIAL ENTRY BLANK.
3. Then write 50 words or less telling us "Why the TELEX MONOSET is

Better than Old-Style Earphones." Clearness and sincerity will count most.

4. Print or type your answer on the OFFICIAL ENTRY BLANK your jobber will give you.

Mail direct to: TELEX, INC., Telex Park, Minneapolis 1, Minnesota, before Midnight October 15, 1947.

FIRST PRIZE: \$100.00 cash and a TELEX MONOSET
SECOND PRIZE: \$ 50.00 cash and a TELEX MONOSET
THIRD PRIZE: \$ 25.00 cash and a TELEX MONOSET

TELEX MONOSETS to the 22 next best opinions. In case of a tie, *duplicate* prizes will be awarded.

Employees of Telex, Inc. and their advertising agency not eligible to enter this contest.

NO BOX TOPS!
NO JINGLES!
Get Entry Blank
From Your Parts
Jobber

CONTEST CLOSES MIDNIGHT OCTOBER 15, 1947!

TIPS TO GET STARTED WITH:

1. TELEX MONOSET is quickly replacing old-style, cumbersome headsets because you wear it under-the-chin instead of over-the-head.
2. Featherweight: Only 1.2 oz. No ear fatigue.
3. Excellent fidelity. Clear, natural reception of sound.
4. Reliable performance assured by TELEX precision engineering.
5. Exclusive, TELEX designed, volume control—permits individual adjustment of volume.

Decision of impartial judges will be final. All entries become property of Telex, Inc. Winners will be notified by mail approximately November 1, 1947. Contest subject to all state and federal regulations.

Remember, wherever a headset is used—TELEX MONOSET will do the job better.



SYLVANIA NEWS

RADIO SERVICE EDITION

AUGUST Prepared by SYLVANIA ELECTRIC PRODUCTS INC., Emporium, Pa. 1947

IT PAYS! — IDENTIFY YOUR STORE WITH THESE FREE AND LOW-PRICED SELLING AIDS

Take full advantage of these specially prepared sales aids—it pays! High-quality store identification is one of the best means of indicating the type of service you're prepared to offer.

And when these attractive display pieces show that you're selling the finest line of radio tubes made—well, you have the ideal way of building up sales! Note eye-catching variety below.



This attractive display stands approximately 3½ feet high. Available in 10-inch size for counters.

FREE—

FREE—

Decal for store doors or windows; and dummy cartons in standard and 20" sizes.



Get this low-priced weatherproof service banner—46" x 28". For truck, shop, window! 40¢ each; 3—\$1.00.



14½" high by 10¼" wide by 7" deep, this colorful display is fitted with flasher unit that lights message every other second! A must for your window. Only \$2.00.



Wonderful new 15" diameter clock, in color. Telechron movement sealed in oil; case in brown crinkle finish with silver-colored rim. Only \$8.50.



SUPPLEMENT SYLVANIA'S ADVERTISING CAMPAIGN

with the sales aids shown. Life, Collier's, Saturday Evening Post, with a combined weekly circulation of close to 12,000,000, carry ads that sell you, your product and service. To profit from this national campaign use these tested, "on the spot" selling aids.

Order from your Sylvania Distributor or write Sylvania Electric Products Inc., Emporium, Pa.

SYLVANIA ELECTRIC

MAKERS OF RADIO-TUBES; CATHODE RAY TUBES; ELECTRONIC DEVICES; FLUORESCENT LAMPS; FIXTURES; WIRING DEVICES; ELECTRIC-LIGHT BULBS